



SEA-BIRD
SCIENTIFIC

Operation Manual

HydroCAT-EP Recorder

Conductivity, Temperature, pH (Pressure, Optical Dissolved Oxygen, chlorophyll Fluorescence, & Turbidity optional) Recorder with integral Pump & SDI-12 and RS-232 Interface

Release Date:	02/13/17
Version	003
Firmware	5.0.0 & later
Software	UCI 1.1.0 & later



For most applications, deploy in orientation shown (connector end up) for proper operation



service@seabird.com | support@seabird.com | Tel: +1 425 643 9866

Limited Liability Statement

Extreme care should be exercised when using or servicing this equipment. It should be used or serviced only by personnel with knowledge of and training in the use and maintenance of oceanographic electronic equipment.

SEA-BIRD ELECTRONICS, INC. disclaims all product liability risks arising from the use or servicing of this system. SEA-BIRD ELECTRONICS, INC. has no way of controlling the use of this equipment or of choosing the personnel to operate it, and therefore cannot take steps to comply with laws pertaining to product liability, including laws which impose a duty to warn the user of any dangers involved in operating this equipment. Therefore, acceptance of this system by the customer shall be conclusively deemed to include a covenant by the customer to defend, indemnify, and hold SEA-BIRD ELECTRONICS, INC. harmless from all product liability claims arising from the use or servicing of this system.

Declaration of Conformity

DECLARATION OF CONFORMITY

Manufacturer's Name: Sea-Bird Electronics
Manufacturer's Address: 13431 NE 20th St
Bellevue, WA 98005, USA

The Authorized Representative located within the Community is:
OTT MESstechnik gmbH & Co.KG
P.O. Box: 2140 / 87411 Kempten / Germany
Ludwigstrasse 16 / 87437 Kempten
Internet: <http://www.ott.com>
Phone: +49 831 5617 – 100
Fax: +49 831 5617 – 209

Device Description: Various data acquisition Devices and Sensors

Model Numbers:
39plus 39plus-IM HydroCat-EP
16plusV2 16plusV2-IM 19pV2
NiMH Battery Charger and Battery Pack

Applicable EU Directives: Machinery Directive 98 / 37 / EC
EMC Directive 2004 / 108 / EC
Low Voltage Directive (73 / 23 / EEC) as amended by (93 / 68 / EEC)

Applicable Harmonized Standards:
EN 61326-2-3 (2013) Class C Electrical Equipment for Measurement, Control, and Laboratory Use, EMC Requirement – Part 1: General Requirements (EN 55011:2007 Group 1, Class A)

EN 61010-1:2001, Safety Requirements for Electrical Equipment for Measurement, Control, and Laboratory Use – Part 1: General Requirements

I, the undersigned, hereby declare that the equipment specified above conforms to the relevant sections of the above European Union Directives and Standards. The units comply with all applicable Essential Requirements of the Directives.

Authorized Signature / Date:

 3/23/2016

Name: Casey Moore
Title: President
Place: Bellevue, WA

Table of Contents

Limited Liability Statement	2
Declaration of Conformity	3
Table of Contents	4
Section 1: Introduction	7
About this Manual	7
Quick Start	8
Unpacking HydroCAT-EP	10
Shipping Precautions	11
Section 2: Description of HydroCAT-EP	12
System Description	12
Specifications	14
Dimensions and End Cap Connector	16
Cables and Wiring	17
Pump Operation	18
Pre-flush for Pump Turn-On at Start of Deployment	18
Minimum Conductivity Frequency for Pump Turn-On	18
Pumping Time and Speed - DO Sensor NOT Installed	18
Pumping Time and Speed – DO Sensor Installed	19
Sample Timing	19
Battery Pack Endurance	20
External Power	21
Cable Length and External Power	21
Section 3: Preparing HydroCAT-EP for Deployment	23
Battery Pack Installation	23
Software Installation	25
Power and Communications Test	25
Test Setup	25
Test	26
Section 4: Deploying and Operating HydroCAT-EP	27
Sampling Modes	27
Polled Sampling	28
Autonomous Sampling (Logging commands)	29
RS-232 Real-Time Data Acquisition	30
Timeout Description	30
Command Descriptions – Transmission via RS-232	30
Command Descriptions and Data Output Format – Transmission via SDI-12	31
SDI-12 Standard Commands	31
SDI-12 Extended Commands	33
SDI-12 Data Format	34
RS-232 Data Formats	36
Optimizing Data Quality	41
Background Information	41
Deployment Recommendations	41
Setup for Deployment	42
Deployment	43
Recovery	44
Uploading and Processing Data	45

Section 5: Routine Maintenance and Calibration	46
Cleaning and Corrosion Precautions	46
Connector Mating and Maintenance	47
Handling Instructions	48
O-Ring Maintenance	49
Replacing AA Cells	49
Replacing Anti-Foulant Devices – Mechanical Design Change	50
Replacing Anti-Foulant Devices (SBE 37-SI, SM, IM).....	51
Conductivity Cell and (optional) Dissolved Oxygen Sensor Maintenance	52
Cleaning Guidelines.....	52
Cleaning Materials	52
Conductivity Check	53
Filling / Flushing Procedure	53
Temperature Check	54
Pressure Sensor (optional) Maintenance	54
Optics (optional) Maintenance – HCO and HCC (check cap)	55
HCO Optics	55
HCO Wiper	55
HCC (check cap).....	57
pH Sensor Maintenance and Replacement.....	58
Uninstalling pH Sensor from HydroCAT-EP	58
Rebuilding pH Reference Junction	59
Installing pH Sensor on HydroCAT-EP	60
Updating pH Calibration Coefficients in HydroCAT-EP	60
Pump Maintenance	60
Sensor Calibration.....	61
Conductivity Sensor Calibration.....	61
Temperature Sensor Calibration	61
Dissolved Oxygen Sensor (optional) Calibration	61
Pressure Sensor (optional) Calibration	62
pH Sensor Calibration.....	63
HCO (optional Fluorometer and Turbidity) Calibration Check.....	65
Section 6: Troubleshooting	66
Problem 1: Unable to Communicate with HydroCAT-EP	66
Problem 2: No Data Recorded	66
Problem 3: Unreasonable Data	66
Problem 4: Salinity Spikes	67
Problem 5: HCO Wiper Arm Malfunction.....	68
Problem 6: HCO Calibration Check Failure	68
Glossary	69
Appendix I: Functional Description	70
Sensors	70
Conductivity and Temperature Sensor Interface.....	70
Real-Time Clock.....	70
HCO Calibration Process	71
Chlorophyll Calibration	71
Turbidity (NTU) Calibration	71
Appendix II: Electronics Disassembly/Reassembly	72
Appendix III: RS-232 Command Summary and Details	75
Command Summary	76
Detailed Command Descriptions	80
Calculation of Oxygen Saturation.....	103

Appendix IV: AF24173 Anti-Foulant Device 104
Appendix V: Sources of Variability in HCO Calibration Check 108
Appendix VI: Replacement Parts 110
Appendix VII: Manual Revision History 112
Index..... 113

Section 1: Introduction

This section includes a Quick Start procedure, photos of a typical HydroCAT-EP shipment, and battery shipping precautions.

About this Manual

This manual is to be used with the HydroCAT-EP Conductivity, Temperature, (optional) Pressure, (optional) Optical Dissolved Oxygen, pH, (optional) Chlorophyll Fluorometer, and (optional) Turbidity Recorder with SDI-12 and RS-232 Serial interfaces, internal Memory, and integral Pump. It is organized to guide the user from installation through operation and data collection. We've included detailed specifications, command descriptions, maintenance and calibration information, and helpful notes throughout the manual.

Sea-Bird welcomes suggestions for new features and enhancements of our products and/or documentation. Please contact us with any comments or suggestions (seabird@seabird.com or +1 425-643-9866). Our business hours are Monday through Friday, 0800 to 1700 Pacific Standard Time (1600 to 0100 Universal Time) in winter and 0800 to 1700 Pacific Daylight Time (1500 to 0000 Universal Time) the rest of the year

Quick Start

Follow these steps to get a Quick Start using the HydroCAT-EP with the Universal Coastal Interface (UCI) software.

The manual provides step-by-step details for performing each task:

1. Install AA lithium cells, install cable, and test power and communications (*Section 3*).
2. Install pH sensor (pH sensor ships uninstalled, with a cap to keep the sensor wetted) (*Section 5*).
3. Set up, test, and deploy HydroCAT-EP (*Sections 3 and 4*):
 - A. Via **Transfer Data** in UCI, ensure all data has been uploaded.
 - B. Remove yellow protective label from plumbing intake and exhaust.
 - C. Remove red vinyl cap from end of HCO (optional fluorescence and turbidity sensor).
 - D. (if desired) Via **Conductivity Check** in UCI, verify the conductivity output stability and accuracy.
 - E. (if desired) Via **Temperature Check** in UCI, verify the temperature output stability and accuracy.
 - F. (if desired) Via **Optics Check** in UCI, verify the optics output (fluorometer and turbidity sensor) stability and accuracy.
 - G. (if desired) Via **pH Calibration** in UCI, verify the pH sensor stability and accuracy / update the pH calibration coefficients.
 - H. Via **HydroCAT-EP Settings** in UCI, establish setup parameters.
 - I. Via **Command Terminal** in UCI, check configuration (**GetCD**) and calibration coefficients (**GetCC**) to verify setup.
 - J. Via **Start** in UCI, start autonomous sampling and view data in the Real Time Display and the Time Series plot to verify setup and operation. Click **Stop** when you are done.
 - K. Via **Deployment Wizard** in UCI:
 - Set Operating Mode (Autonomous or Polled Sampling).
 - For Autonomous Sampling, set sample interval and start date and time.
 - For Polled Sampling via SDI-12: set SDI-12 address and bad data flag.
 - Set parameters to output and parameter units for real-time data.
 - Synchronize time in HydroCAT-EP with computer time, and (if desired) make entire memory available for recording.
 - L. Remove copper anti-foulant assembly and anti-foulant cap, and verify AF24173 Anti-Foulant Devices are installed (*Section 5: Routine Maintenance and Calibration*). Replace cap and assembly.
 - M. Verify that yellow protective label over intake and exhaust and red vinyl cap from end of HCO are **not installed** for deployment.

Note:

The conductivity cell must have all salt water residue removed and be dry for the first part of the Conductivity Check, which checks the *Zero Conductivity Frequency*. Rinse the cell well with fresh water, and then shake out any water. **Do not use compressed air**, which typically contains oil vapor, to dry the cell. See *Conductivity and (optional) Dissolved Oxygen Sensor Maintenance* in *Section 5: Routine Maintenance and Calibration* for details on using the syringe kit to flush and fill the cell for the Conductivity Check.

Notes for Autonomous Sampling:

- You can program an RS-232 controller to send periodic requests to transmit the last data sample from the HydroCAT-EP memory (**SL**) while sampling autonomously.
- You cannot view real-time autonomous data **in UCI** if you start autonomous sampling via **Deployment Wizard**. UCI automatically disconnects from the HydroCAT-EP when you click **Finish**, and automatically sends a command to stop logging when you reconnect. If desired, you can connect to the HydroCAT-EP with a terminal program to view real-time data.

- N. (if doing autonomous sampling and not viewing real-time data)
Install dummy plug and locking sleeve.
- O. For SDI-12 deployments: Program SDI-12 controller to send periodic requests to run pump and sample (aM!, aMC!, aC!, or aCC! store data in HydroCAT-EP FLASH memory; aM1!, aMC1!, aC1!, or aCC1! do not store data in FLASH memory), and then transmit sample (aD0!, aD1!, aD2!). **Note that HydroCAT-EP must be externally powered when communicating via SDI-12; the SDI-12 interface in the HydroCAT-EP is not powered by the internal battery pack.**
- P. Deploy HydroCAT-EP. For **most** applications, mount the HydroCAT-EP with the connector at the top (sensors at bottom) for proper operation.
- Prior to deployment, fill the plumbing with water (*Section 5: Routine Maintenance and Calibration*). Then place the HydroCAT-EP in the water in a vertical position (connector end up) and shake it before attaching it to the mooring, to purge any air from the flow path.
- Q. Via **Transfer Data** in UCI, upload data from memory. Review data; you can modify the parameters output and / or the units (via **HydroCAT-EP Settings**) and upload again if desired.

Unpacking HydroCAT-EP

Shown below is a typical HydroCAT-EP shipment.



HydroCAT-EP
(shown with optional sensors
and bail mounting kit installed)



pH sensor and cap
(filled with KCl solution to keep
glass bulb and reference
electrode from drying)



12 AA lithium cells



I/O cable



Spare hardware
and o-ring kit



Conductivity cell cleaning
solution (Triton-X)



Software, and Electronic Copies of
Software Manuals and User Manual

Shipping Precautions

DISCLAIMER / WARNING:

The shipping information provided in is a general overview of lithium battery shipping requirements; it does not provide complete shipping information. The information is provided as a courtesy, to be used as a guideline to assist properly trained shippers. These materials do not alter, satisfy, or influence any federal or state requirements. These materials are subject to change due to changes in government regulations. Sea-Bird accepts no liability for loss or damage resulting from changes, errors, omissions, or misinterpretations of these materials. **See the current edition of the IATA Dangerous Good Regulations for complete information on packaging, labeling, and shipping document requirements.**



WARNING!
Do not ship assembled battery pack.

Assembled battery pack

For its main power supply, the HydroCAT-EP uses twelve 3.6-volt AA lithium cells (Saft LS14500). The HydroCAT-EP was shipped from the factory with the cells packaged separately within the shipping box (not inside HydroCAT-EP).

BATTERY PACKAGING

Cells are packed in heat-sealed plastic, and then placed in bubble-wrap outer sleeve and strong packaging for shipment.



If the shipment is not packaged as described above, or does not meet the requirements below, the shipment is considered Dangerous/Hazardous Goods, and must be shipped according to those rules.

	1-5 HydroCAT-EPs and associated cells, but no spares	1-5 HydroCAT-EPs and associated cells, plus up to 2 spare cell sets/HydroCAT-EP	Spares (without HydroCAT-EPs) – Note new rules as of January 1, 2013
UN #	UN3091	UN3091	Must be shipped as Class 9 Dangerous Goods . If re-shipping spares, you must have your own Dangerous Goods program.
Packing Instruction (PI) #	969	969	
Passenger Aircraft	Yes	No	
Cargo Aircraft	Yes	Yes	
Labeling Requirement	1 **	1, 2 **	
Airway Bill (AWB) Requirement	Yes *	Yes *	

* AWB must contain following information in Nature and Quantity of Goods Box: "Lithium Metal Batteries", "Not Restricted", "PI #"

** Labels are defined below:



1 – Shipper must provide an emergency phone number

Note:

Remove the cells before returning the HydroCAT-EP to Sea-Bird. Do not return used cells when shipping the HydroCAT-EP for calibration or repair. All setup information is preserved when the cells are removed.

Install the battery pack assembly in the HydroCAT-EP for testing (see *Battery Installation* in Section 3). **If you will re-ship the HydroCAT-EP after testing:**

1. Remove the battery pack assembly from the HydroCAT-EP.
2. Remove the cells from the battery pack assembly.
3. Pack the cells properly for shipment, apply appropriate labels, and prepare appropriate shipping documentation.

Section 2: Description of HydroCAT-EP

This section describes the functions and features of the HydroCAT-EP, including specifications, dimensions, end cap connectors, sample timing, battery pack endurance, and external power.

System Description



For most applications, deploy in orientation shown (connector end up) for proper operation – see *Optimizing Data Quality* in *Section 4: Deploying and Operating HydroCAT*

Shown with optional sensors and bail mounting kit installed

Note:

If connected to a USB port, a RS-232 to USB converter is required. See *Application Note 68: Using USB Ports to Communicate with Sea-Bird Instruments*.

The HydroCAT-EP is a high-accuracy conductivity and temperature recorder (pressure optional) with internal battery pack and non-volatile memory, an integral pump, an SDI-12 interface, and an RS-232 serial interface. The HydroCAT-EP also includes an (optional) Optical Dissolved Oxygen (DO) sensor (SBE 63), pH sensor, and (optional) chlorophyll fluorometer and turbidity sensor (HCO). Designed for moorings and other long-duration, fixed-site deployments, HydroCAT-EPs have non-corroding plastic housings rated for operation to 350 meters (1150 feet) or pressure sensor full-scale range.

For setup and data upload, communication with the HydroCAT-EP is over an internal, 3-wire, RS-232C link. Over 50 different commands can be sent to the HydroCAT-EP to provide status display, data acquisition setup, data retrieval, and diagnostic tests.

User-selectable operating modes include:

- **Polled sampling** – On command, the HydroCAT-EP runs the pump, takes one sample, and transmits data. Alternatively, the HydroCAT-EP can be commanded to transmit the last sample in its memory while it is sampling autonomously. Polled sampling is useful for integrating the HydroCAT-EP with satellite, radio, or wire telemetry equipment. Polled sampling can be accomplished via the HydroCAT-EP RS-232 interface or the SDI-12 interface.
- **Autonomous sampling** (not compatible with SDI-12 deployments) – At pre-programmed intervals, the HydroCAT-EP wakes up, runs the pump, samples, stores data in memory, and goes to sleep. If desired, real-time data can also be transmitted.

The HydroCAT-EP can be deployed in three ways:

- **Connected to RS-232 or USB port** on computer – The HydroCAT-EP can be remotely controlled, allowing for polled sampling or for periodic requests of data from the HydroCAT-EP memory while the HydroCAT-EP is sampling autonomously. If desired, data can be periodically uploaded while the HydroCAT-EP remains deployed. The HydroCAT-EP can be externally powered.
- **Connected to SDI-12 controller** - The HydroCAT-EP can be remotely controlled, allowing for polled sampling. **Note that the HydroCAT-EP must be externally powered when communicating via SDI-12.**
- **Dummy plug installed** – The HydroCAT-EP cannot be remotely controlled or externally powered. Autonomous sampling is programmed before deployment, and data is uploaded after recovery.

Calibration coefficients stored in EEPROM allow the HydroCAT-EP to transmit conductivity, temperature, pressure, and oxygen data in engineering units. The HydroCAT-EP retains the temperature and conductivity sensors used in the Sea-Bird Electronics' SeaCAT and SeaCAT*plus* family. The HydroCAT-EP's aged and pressure-protected thermistor has a long history of exceptional accuracy and stability (typical drift is less than 0.002 °C per year). Electrical isolation of the conductivity electronics eliminates any possibility of ground-loop noise.

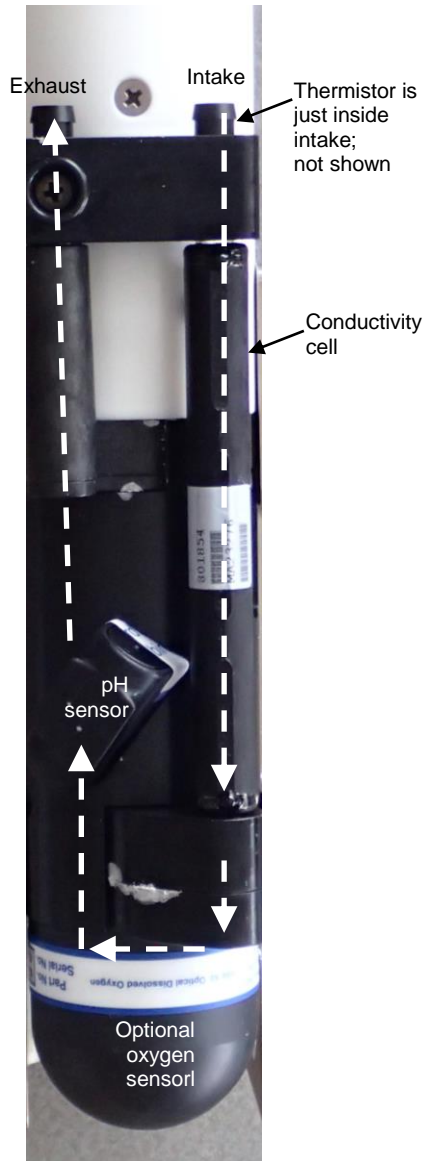

Shown with conductivity cell guard and anti-foulant fittings removed.
 Note: Optional HCO (fluorescence and turbidity sensor) is not in the pumped flow path.

The HydroCAT-EP's internal-field conductivity cell is immune to proximity errors and unaffected by external fouling. The conductivity cell guard retains the expendable AF24173 Anti-Foulant Devices.

The HydroCAT-EP's integral pump runs each time the HydroCAT-EP takes a sample, providing the following advantages over a non-pumped system:

- Improved conductivity and oxygen response – The pump flushes the previously sampled water from the conductivity cell and oxygen sensor plenum, and brings a new water sample quickly into the system.
- Improved anti-foul protection – Water does not freely flow through the conductivity cell between samples, allowing the anti-foul concentration inside the system to maintain saturation.
- Improved measurement correlation – The individually calibrated SBE 63 Optical Dissolved Oxygen sensor is integrated within the CTD flow path, providing optimum correlation with CTD measurements.

Pump run time is dependent on whether the dissolved oxygen sensor is installed:

- Dissolved oxygen sensor **not** installed - The pump runs for 1.0 second before each sample.
- Dissolved oxygen sensor installed – The pump runs for a user-programmable time (or a multiple of oxygen sensor response time).

The HydroCAT-EP's optional strain-gauge pressure sensor is available in the following pressure ranges: 20, 100, and 350 meters. Compensation of the temperature influence on pressure offset and scale is performed by the HydroCAT-EP's CPU.

Future upgrades and enhancements to the HydroCAT-EP firmware can be easily installed in the field through a computer serial port and the bulkhead connector on the HydroCAT-EP, without the need to return the HydroCAT-EP to Sea-Bird.

Notes:

- Help files provide detailed information on the use of the software.
- Sea-Bird supplies the current version of our software when you purchase an instrument. As software revisions occur, we post the revised software. See our website (www.seabird.com) for the latest software version number, a description of the software changes, and instructions for downloading the software.

The HydroCAT-EP is supplied with a powerful Windows software package that includes software for determining deployment length and for setting up, running validation checks, uploading data, and plotting data from the HydroCAT-EP.

Specifications

	Measurement Range	Initial Accuracy	Typical Stability	Resolution	Calibration (measurement outside these ranges may be at slightly reduced accuracy due to extrapolation errors)
Temperature	-5 to +45 °C	± 0.002 °C (-5 to 35 °C); ± 0.01 °C (35 to 45 °C)	0.0002 °C/month	0.0001 °C	+1 to +32 °C
Conductivity	0 to 7 S/m (0 to 70 mS/cm)	± 0.0003 S/m (0.003 mS/cm)	0.0003 S/m (0.003 mS/cm)/month	0.00001 S/m (0.0001 mS/cm)	0 to 6 S/m; physical calibration over range 2.6 to 6 S/m, plus zero conductivity (air)
Pressure (optional)	0 to full scale range: 20/100/350 m (deployment depth capability)	± 0.1% of full scale range	0.05% of full scale range/year	0.002% of full scale range	Ambient pressure to full scale range in 5 steps
Dissolved Oxygen (optional)	0 to 200% of surface saturation in all natural waters, fresh and salt	Larger of ± 0.14 ml/L (equivalent to 0.2 mg/L) or ±2%	Sample-Based Drift: < 0.03 ml/L/ 100,000 samples (20 °C) Typical Stability < 2% drift / year, as there is a small storage drift that is unrelated to sample-based drift]	0.005 ml/L	Individually calibrated at 30 points (0–17.5 ml/L [25 mg/L] oxygen, 2-30 °C, 0-35 psu; 8 coefficients plus 4 temperature compensation coefficients
pH	0 to 14 pH	± 0.1 pH	± 0.1 pH/3 months	0.01 pH	4, 7, & 10 pH

	Wavelength	Measurement Range	Sensitivity	Linearity	Accuracy and Resolution
Chlorophyll Fluorescence (optional)	ex/em 470/695 nm	0 to 400 µg/L	0.025 µg/L	0.99 Rsquared	Accuracy Linearity R ² > 0.999 for serial dilution of Uranine (fluorescein) solution from 0 - 1885 ppb uranine (0 – 400 µg/l chlorophyll equivalents), and ±3% difference in slope using independent data set
Turbidity (optional)	700 nm	0 to 3000 NTU	0.01 µg/L		Accuracy Linearity R ² > 0.999 for serial dilution of formazin solution from 0 – 3000 NTU, and ±1% difference in slope using independent data set Resolution 0.006 NTU from 0 - 85 NTU; 0.033 from 86 - 550 NTU; 0.17 NTU from 551 - 3,000 NTU.

Memory	16 Mbyte non-volatile FLASH memory										
Data Storage	<p>Conductivity & temperature: 6 bytes/sample (3 bytes each). Oxygen (optional): 6 bytes/sample. Pressure (optional): 5 bytes/sample. pH: 3 bytes/sample. Fluorescence & Turbidity (optional): 52 bytes/sample (26 each). Time: 4 bytes/sample. Error flag: 2 bytes/sample.</p> <table border="1"> <thead> <tr> <th><u>Recorded Parameters</u></th> <th><u>Memory Space (number of samples)</u></th> </tr> </thead> <tbody> <tr> <td>C, T, pH, time, flag (no pressure, oxygen, FI, Turbidity) (15 bytes)</td> <td>1,118,400</td> </tr> <tr> <td>C, T, P, pH, FI, Turbidity, time, flag (no oxygen) (72 bytes)</td> <td>233,000</td> </tr> <tr> <td>C, T, DO, pH, FI, Turbidity, time, flag (no pressure) (73 bytes)</td> <td>229,800</td> </tr> <tr> <td>All sensors - C, T, P, DO, pH, FI, Turbidity, time, flag (78 bytes)</td> <td>215,000</td> </tr> </tbody> </table>	<u>Recorded Parameters</u>	<u>Memory Space (number of samples)</u>	C, T, pH, time, flag (no pressure, oxygen, FI, Turbidity) (15 bytes)	1,118,400	C, T, P, pH, FI, Turbidity, time, flag (no oxygen) (72 bytes)	233,000	C, T, DO, pH, FI, Turbidity, time, flag (no pressure) (73 bytes)	229,800	All sensors - C, T, P, DO, pH, FI, Turbidity, time, flag (78 bytes)	215,000
<u>Recorded Parameters</u>	<u>Memory Space (number of samples)</u>										
C, T, pH, time, flag (no pressure, oxygen, FI, Turbidity) (15 bytes)	1,118,400										
C, T, P, pH, FI, Turbidity, time, flag (no oxygen) (72 bytes)	233,000										
C, T, DO, pH, FI, Turbidity, time, flag (no pressure) (73 bytes)	229,800										
All sensors - C, T, P, DO, pH, FI, Turbidity, time, flag (78 bytes)	215,000										
Real-Time Clock	32,768 Hz TCXO accurate to ±1 minute/year.										
Internal Battery Pack	<p>Nominal 7.8 Amp-hour pack consisting of 12 AA Saft LS 14500 lithium cells (3.6 V and 2.6 Amp-hours each), with 3 strings of 4 cells. For battery pack endurance calculations, derated capacity of 257 KJoules. See <i>Battery Pack Endurance</i> for example sampling calculation. See <i>Shipping Precautions</i> in <i>Section 1: Introduction</i>. Note: Saft batteries can be purchased from Sea-Bird or other sources. See Saft's website for suppliers (www.saftbatteries.com). Alternatively, substitute either of the following: - Tadiran TL-4903, AA (3.6 V and 2.4 Amp-hours each) (www.tadiran.com) - Electrochem 3B0064/BCX85, AA (3.9 V and 2.0 Amp-hours each) (www.electrochemsolutions.com)</p>										
External Power	0.25 Amps at 9 - 24 VDC. To avoid draining internal battery pack, use an external voltage greater than 16 VDC. See <i>External Power</i> . HydroCAT-EP must be externally powered when communicating via SDI-12.										

<p>Power Consumption (all values measured with 12 V input)</p>	<ul style="list-style-type: none"> • Quiescent: 0.0012 W not connected, 0.0156 W connected via RS-232. • Pump preflush: 0.12 W • Pump before and during sampling: 2 sec at 1 W (only if optional oxygen sensor installed), then 0.12 W for remainder of pump time <ul style="list-style-type: none"> T, C, pH – (1.7 sec) T, C, pH, P – (1.7 sec) T, C, pH, DO – (2.2 sec during sample + programmable time before sample - 1) T, C, pH, P, DO – (2.2 sec during sample + programmable time before sample - 1) T, C, pH, HCO – (1.7 sec) T, C, pH, HCO, P - (1.7 sec) T, C, pH, HCO, DO – (2.2 sec during sample + programmable time before sample - 1) T, C, pH, HCO, P, DO – (2.2 sec during sample + programmable time before sample - 1) • Sampling: <ul style="list-style-type: none"> T, C, pH – 0.6 Joules (6 sec sampling time) T, C, pH, P – 0.6 Joules (6 sec sampling time) T, C, pH, DO – 0.7 Joules (6 sec sampling time) T, C, pH, P, DO – 0.8 Joules (6 sec sampling time) T, C, pH, HCO – 13.6 Joules (33 sec sampling time) T, C, pH, HCO, P -13.6 Joules (33 sec sampling time) T, C, pH, HCO, DO – 13.7 Joules (33 sec sampling time) T, C, pH, HCO, P, DO – 13.8 Joules (33 sec sampling time) • Communications: 0.06 W
<p>Housing Material and Depth Rating</p>	<p>Plastic housing rated at 350 m (1150 ft)</p>
<p>Weight</p>	<p>With all optional sensors : 4.05 kg (9.0 lbs) in air, 1.5 kg (3.3 lbs) in water With optional pressure and dissolved oxygen: 3.80 kg (8.4 bs) in air, 1.6 kg (3.5 lbs) in water With optional pressure: 3.55 kg (7.9 lbs) in air</p>

Dimensions and End Cap Connector

Notes:

- For most applications, deploy in the orientation shown (connector end up) for proper operation.
- Shown with optional bail mounting kit installed.

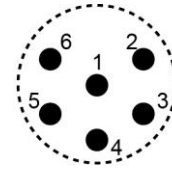

Wet-Pluggable
MCBH-6MP (WB), T1
(3/8" length base,
1/2-20 thread)

Pin	Signal
1	Common
2	RS-232 data receive
3	RS-232 data transmit
4	SDI-12 data transmit
5	--
6	9-24 VDC external power

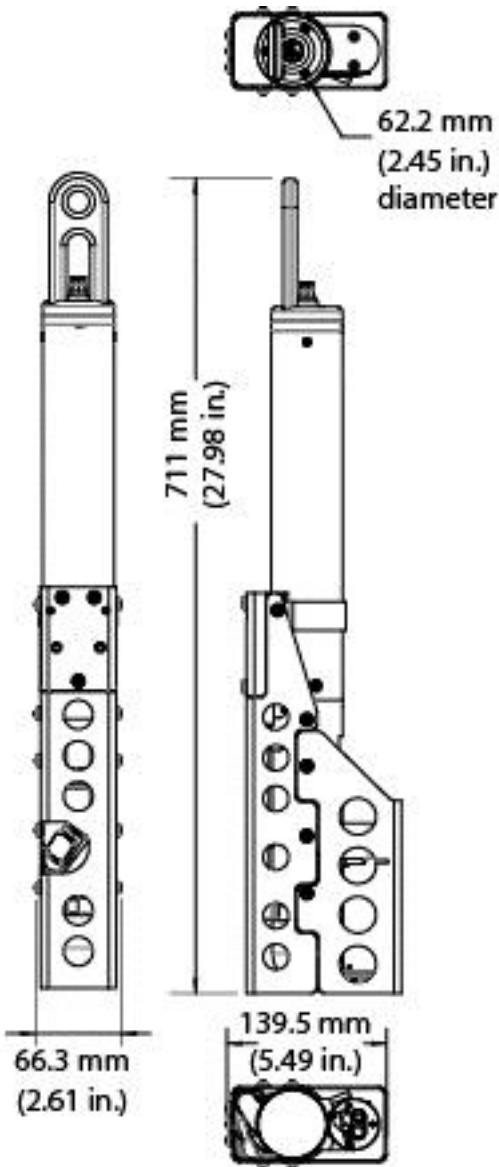

With all optional sensors

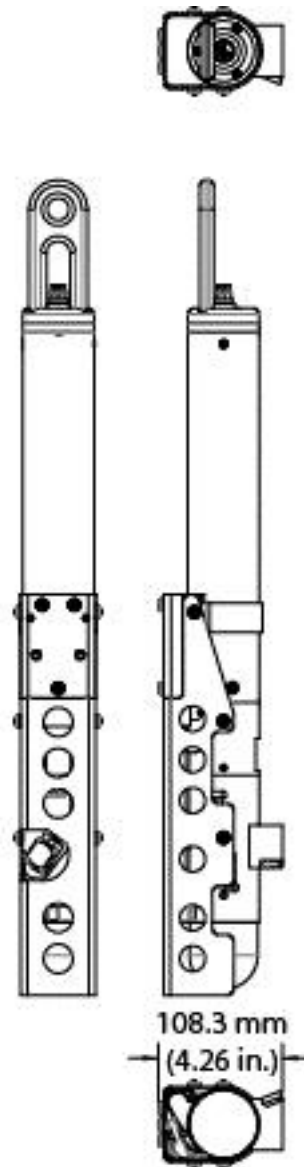

**Without optional HCO
(chlorophyll & turbidity sensor)**

Cables and Wiring

MCIL Wet-Pluggable Connector Cable Wiring -- DN 33733

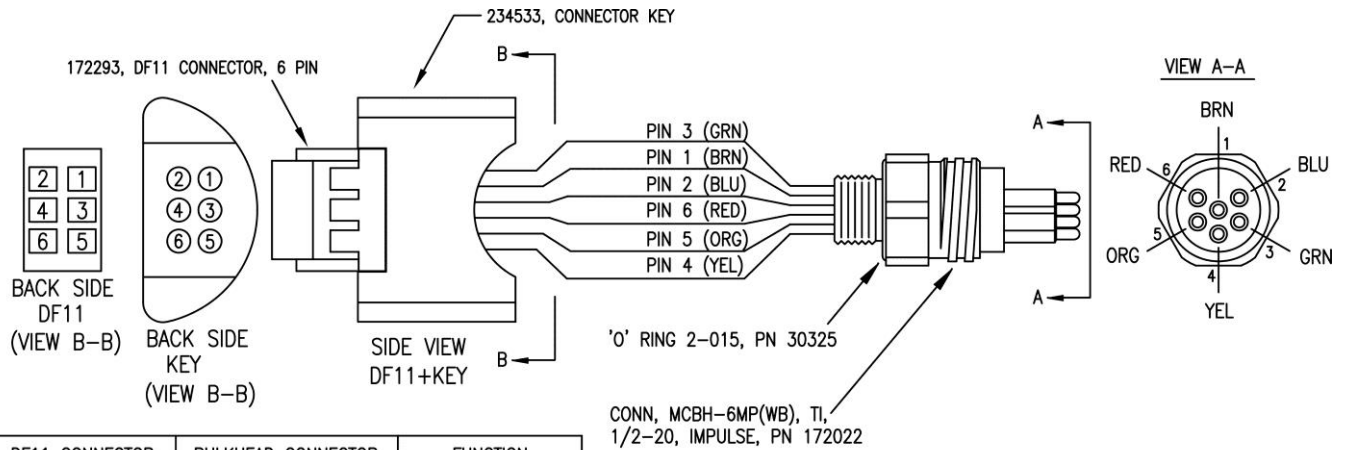
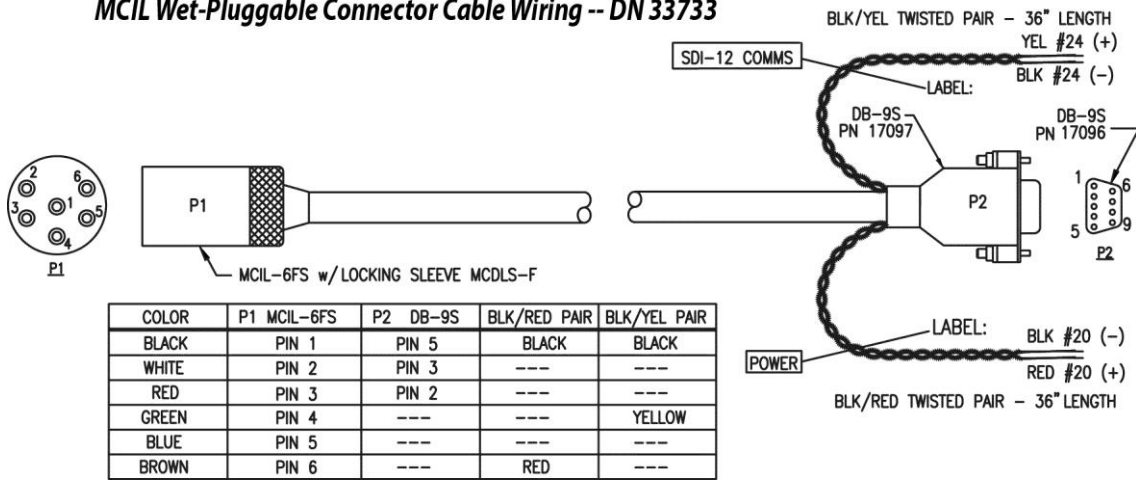

DF11 CONNECTOR	BULKHEAD CONNECTOR	FUNCTION
PIN 1	PIN 3 (GRN)	TX TO PC
PIN 2	PIN 1 (BRN)	COMMON
PIN 3	PIN 2 (BLU)	RX FROM PC
PIN 4	PIN 6 (RED)	EXTERNAL PWR
PIN 5	PIN 5 (ORG)	NO CONNECT
PIN 6	PIN 4 (YEL)	SDI-12

Pump Operation

Note:

The HydroCAT-EP does **not** check the conductivity frequency (see *Minimum Conductivity Frequency for Pump Turn-On* below) before running the pump for the pre-flush, because the purpose of the pre-flush is to remove air from the plumbing.

Pre-flush for Pump Turn-On at Start of Deployment

The HydroCAT-EP provides additional pumping time at the beginning of a deployment to get air out of the plumbing and allow the pump to prime before taking the first measurement. The pre-flush can range from 300 to 600 sec (default 300 sec).

- If **autonomous** sampling is started with **StartNow**, pre-flush pumping starts immediately.
- If **autonomous** sampling is started with **StartLater**, pre-flush pumping starts **Preflush** seconds before the scheduled start time.
- For **polled** sampling, pre-flush pumping starts at **PreflushStartTime**.

Note:

The Zero Conductivity Frequency is found on the Calibration Sheet and is also provided in the HydroCAT-EP's response to the **GetCC** command; it is listed as **Z=** in the conductivity section of the response. See *Appendix III: RS-232 Command Summary and Details* for an example **GetCC** response.

Minimum Conductivity Frequency for Pump Turn-On

The integral pump is water lubricated; running it *dry* for an extended period of time will damage it. To prevent the pump from running dry while sampling, the HydroCAT-EP checks the raw conductivity frequency (Hz) from the last sample against the user-input Minimum Conductivity Frequency. If the raw conductivity frequency is greater than the Minimum Conductivity Frequency, it runs the pump before taking the sample; otherwise it does not run the pump.

The HydroCAT-EP Calibration Sheet lists the uncorrected (raw) frequency output at 0 conductivity (also called the Zero Conductivity Frequency).

- **Fresh Water** applications: Typical Minimum Conductivity Frequency is (Zero Conductivity Frequency + 1 Hz). **Default factory setting.**
- **Salt Water and Estuarine** applications: Typical Minimum Conductivity Frequency is (Zero Conductivity Frequency + 500 Hz).

If the Minimum Conductivity Frequency is too close to the *Zero Conductivity Frequency* (from the HydroCAT-EP Calibration Sheet), the pump may turn on when in air, as a result of small drifts in the electronics. Some experimentation may be required to control the pump, particularly in fresh water applications.

By setting the Minimum Conductivity Frequency to an appropriate value, you can start logging in the lab or on the ship in dry conditions; the pump will not run until you deploy the HydroCAT-EP. Upon recovery, the HydroCAT-EP will continue logging data but the pump will stop running, so a delay in getting the HydroCAT-EP to the lab to stop logging will not damage the pump.

Pumping Time and Speed - DO Sensor NOT Installed

When the dissolved oxygen sensor is not installed, the HydroCAT-EP runs the pump for 1.0 second before each sample.

Pumping Time and Speed – DO Sensor Installed

Notes:

- The pump continues to run while the HydroCAT-EP takes the sample. See *Sample Timing* below for the time to take each sample, which varies depending on the sampling mode, command used to start sampling, whether real-time data is transmitted, and whether the HydroCAT-EP includes a pressure sensor.
- Either **OxNTau=** or **PumpTime=** can be used to define the pump time for each sample; HydroCAT-EP uses the last value entered to calculate and reset the other value.
- The Pump Time does not include the pumping while sampling.

When the dissolved oxygen sensor is installed, the pump runs before and during sampling, flushing the system consistent with the calibration of the oxygen sensor at our factory. The pump runs for a user-programmable time (or a multiple of oxygen sensor response time) **before** each sample, and then continues to run while sampling.

pump time = **PumpTime** or pump time = **OxNTau * SetTau20**
where

- **PumpTime** = pump time programmed in HydroCAT-EP
- **SetTau20** = oxygen calibration coefficient programmed in *SBE 63*
- **OxNTau** = pump time multiplier programmed in HydroCAT-EP

Note that pump operation can impact the allowable interval between samples. HydroCAT-EP will not allow you to set the Sample Interval to less than:

- (pumping time + 38 sec) if your HydroCAT-EP includes the HCO
- (pumping time + 8 sec) if your HydroCAT-EP does **not** include the HCO

For testing and/or to remove sediment from inside the plumbing, the pump can be *manually* turned on and off with the commands sent through a terminal program.

Sample Timing

Notes:

- Either **OxNTau=** or **PumpTime=** can be used to define the pump time for each sample; HydroCAT-EP uses the last value entered to calculate and reset the other value.
- Sampling time shown does not include time to transmit real-time data, which is dependent on baud rate and number of characters being transmitted (defined by commands to enable/disable specific output parameters). These are set in the HydroCAT-EP Settings dialog.
- Time stored and output with the data is the time at the **start** of the sample, after the HydroCAT-EP wakes up, runs the pump, and prepares to sample.

Sample timing is dependent on if the HydroCAT-EP includes the optional dissolved oxygen and/or HCO sensors, pumping time, and if real-time data is transmitted.

- Dissolved oxygen sensor **not** installed – The pump runs for 1.0 sec while the Wein bridge is stabilizing before each measurement.
- Dissolved oxygen sensor installed – Pumping time before each measurement is **OxNTau * SetTau20 (=PumpTime)**.
- Optional HCO installed – HydroCAT-EP takes 30 HCO measurements at approximately 1 Hz.

The sampling sequence is:

1. Run pump for preflush (first sample only).
2. Run pump (pumping time as described above in *Pump Operation*).
3. Take conductivity, temperature, pressure, and oxygen measurement.
4. Stop pump.
5. Take HCO (fluorescence and turbidity) measurement (30 measurements at approximately 1 Hz, calculates averages and standard deviations).
6. Take pH measurement.

Sampling time (does not include pump time before sampling or data transmission time):

- HCO **not** installed: 6 sec
- HCO installed: 33 sec

Minimum time allowable between samples:

- HCO **not** installed: (pumping time + 8 sec)
- HCO installed : (pumping time + 38 sec)

Battery Pack Endurance

Notes:

- If the HydroCAT-EP is logging data and the battery voltage is less than 7.1 volts for five consecutive scans, the HydroCAT-EP halts logging.
- Sea-Bird recommends using the capacity value of 6.0 Amp-hours for the Saft cells as well as the alternate cell types (Tadiran TL-4903 and Electrochem 3B0064/BCX85 AA).
- **See *Specifications* above for data storage limitations.**

The battery pack (4 cells in series, 3 parallel strings) has a nominal capacity of 7.8 Amp-hours (2.6 Amp-hours * 3). For planning purposes, to account for the HydroCAT-EP's current consumption patterns and for environmental conditions affecting cell performance, **Sea-Bird recommends using a conservative value of 6.0 Amp-hours.**

- Power consumption is defined above in *Specifications*.
- The sampling sequence is defined above in *Sample Timing*.
- The pump time is dependent on whether the dissolved oxygen sensor is installed, and various user programmable settings, as summarized above in *Sample Timing*.

So, battery pack endurance is highly dependent on the application. An example is shown below for two sampling schemes.

Example 1 – real-time RS-232 communication at 19200 baud while sampling:

A HydroCAT-EP with all optional sensors is sampling autonomously every 15 minutes (4 samples/hour). Pump time before each sample is set to the default of 38.5 sec (**PumpTime=38.5**). Real-time data is enabled, and baud rate is set to 19200. Output format is converted decimal (**OutputFormat=1**). The HydroCAT-EP is set up to not transmit conductivity, salinity, sound velocity, oxygen saturation, or sample number; it is outputting all other parameters. How long can it be deployed?

CTD-pH-HCO-DO Sampling = 13.8 Joules/sample

In 1 hour, sampling consumption = 4 samples/hour * 13.8 Joules/sample = **55.2 Joules/hour**

Pump (ignoring Preflush, since it is a one-time event at start of sampling)

Pump Time = 2.2 sec during sampling + (38.5 sec before sampling -1) = 39.7 sec

Pumping, (1 W * 2 sec) + 0.12 Watts * (39.7 sec - 2 sec) = 6.52 Joules/sample

In 1 hour, pump consumption = 4 samples/hour * 6.52 Joules/sample = **26.08 Joules/hour**

Communications –see *Data Formats* in *Section 4: Deploying and Operating HydroCAT-EP*.

Number of characters transmitted/sample = 124 (count all characters, including spaces and commas)

Time required to transmit data = 124 characters * 10 bits/character / 19200 baud = 0.0645833 sec

Communication power/sample = 0.06 Watts * 0.065 sec = 0.004 Joules/sample

In 1 hour, consumption = 4 samples/hour * 0.004 Joules/sample = **0.016 Joules/hour**

Quiescent between Samples = 0.0156 Watts

Time = 900 sec - (38.5 sec -1) - 33 sec sample time - 0.0646 sec transmit time = 829.44 sec

Quiescent power between each sample = 0.0156 W * 829.44 sec = 12.94 Joules/sample

In 1 hour, consumption = 4 samples/hour * 12.94 Joules/sample = **51.76 Joules/hour**

Total consumption / hour = 55.2 + 26.08 + 0.02 + 51.76 = **133.06 Joules/hour**

Battery pack capacity

Assume nominal voltage of 14 V and 85% DC/DC converter efficiency

14 V * 6 Amp-hours * 3600 sec/hour * 0.85 = 257040 Joules

Capacity = 257040 Joules / 133.06 Joules/hour = 1931 hours = 80 days

Number of samples = 1931 hours * 4 samples/hour = **7724 samples**

Example 2 – Same as Example 1, but no real-time output:

CTD-pH-HCO-DO Sampling and **Pump** values same as in Example 1. **Communications** power draw is eliminated.

Quiescent between Samples = 0.0012 Watts (not connected)

Time = 900 sec - (38.5 sec -1) - 33 sec sample time = 829.5 sec

Quiescent power between each sample = 0.0012 W * 829.5 sec = 0.9954 Joules/sample

In 1 hour, consumption = 4 samples/hour * 0.9954 Joules/sample = **3.98 Joules/hour**

Total consumption / hour = 55.2 + 26.08 + 3.98 = **85.26 Joules/hour**

Battery pack capacity

Capacity = 257040 Joules / 85.26 Joules/hour = 3014 hours = 125 days

Number of samples = 3014 hours * 4 samples/hour = **12056 samples**

External Power

The HydroCAT-EP can be powered from an external source that supplies 0.25 Amps at 9-24 VDC. The internal lithium pack is diode-OR'd with the external source, so power is drawn from whichever voltage source is higher. The HydroCAT-EP can also be operated from the external supply without having the battery pack installed. Electrical isolation of conductivity prevents ground loop noise contamination in the conductivity measurement.

Note:

See *Real-Time Data Acquisition* in *Section 4: Deploying and Operating HydroCAT-EP* for baud rate limitations on cable length if transmitting real-time data.

Note:

Common wire resistances:

Gauge	Resistance (ohms/foot)
12	0.0016
14	0.0025
16	0.0040
18	0.0064
19	0.0081
20	0.0107
22	0.0162
24	0.0257
26	0.0410
28	0.0653

Cable Length and External Power

There are two issues to consider if powering the HydroCAT-EP externally:

- Limiting the communication IR loss to 1 volt **if transmitting real-time data via RS-232**; higher IR loss will cause the instrument to transmit data that does not meet the RS-232 communication standard.
- Supplying enough power at the power source so that sufficient power is available at the instrument after considering IR loss.

Each issue is discussed below.

Limiting Communication IR Loss to 1 Volt if Transmitting Real-Time Data

The limit to cable length is typically reached when the maximum **communication** current times the power common wire resistance is more than 1 volt.

$$V_{\text{limit}} = 1 \text{ volt} = IR_{\text{limit}}$$

$$\text{Maximum cable length} = R_{\text{limit}} / \text{wire resistance per foot}$$

where I = communication current required by HydroCAT-EP (see *Specifications*: 0.065 Watts / 13 Volts = 0.005 Amps = 5 milliAmps).

Example 1 – For 20 gauge wire, what is maximum distance to transmit power to HydroCAT-EP if transmitting real-time data?

For 5 milliAmp communications current, $R_{\text{limit}} = V_{\text{limit}} / I = 1 \text{ volt} / 0.005 \text{ Amps} = 200 \text{ ohms}$

For 20 gauge wire, resistance is 0.0107 ohms/foot.

Maximum cable length = 200 ohms / 0.0107 ohms/foot = 18691 feet = 6568 meters

Example 2 – Same as above, but there are 4 HydroCAT-EPs powered from the same power supply.

For 4.3 milliAmp communications current, $R_{\text{limit}} = V_{\text{limit}} / I = 1 \text{ volt} / (0.005 \text{ Amps} * 4 \text{ HydroCAT-EPs}) = 50 \text{ ohms}$

Maximum cable length = 50 ohms / 0.0107 ohms/foot = 4672 feet = 1424 meters (to HydroCAT-EP *furthest* from power source)

Supplying Enough Power to HydroCAT-EP

Another consideration in determining maximum cable length is supplying enough power at the power source so that sufficient voltage is available, after IR loss in the cable (***from the 0.25 Amp turn-on transient, two-way resistance***), to power the HydroCAT-EP. The power requirement varies, depending on whether *any* power is drawn from the battery pack:

- Provide at least 16 volts, after IR loss, to prevent the HydroCAT-EP from drawing **any** power from the battery pack (if you do not want to draw down the battery pack): $V - IR \geq 16$ volts
- Provide at least 9 volts, after IR loss, if allowing the HydroCAT-EP to draw down the battery pack or if no battery pack is installed: $V - IR \geq 9$ volts

where I = HydroCAT-EP turn-on transient (0.25 Amps; see *Specifications*).

Example 1 – For 20 gauge wire, what is maximum distance to transmit power to HydroCAT-EP if using 12 volt power source and deploying HydroCAT-EP with no battery pack?

$$V - IR \geq 9 \text{ volts} \quad 12 \text{ volts} - (0.25 \text{ Amps}) * (0.0107 \text{ ohms/foot} * 2 * \text{cable length}) \geq 9 \text{ volts}$$

$$3 \text{ volts} \geq (0.25 \text{ Amps}) * (0.0107 \text{ ohms/foot} * 2 * \text{cable length}) \quad \text{Cable length} \leq 560 \text{ ft} = 170 \text{ meters}$$

Note that 170 m << 6568 m (maximum distance if HydroCAT-EP is transmitting real-time data), so IR drop in power is controlling factor for this example. Using a higher voltage power supply or a different wire gauge would increase allowable cable length.

Example 2 – Same as above, but there are 4 HydroCAT-EPs powered from same power supply.

$$V - IR \geq 9 \text{ volts} \quad 12 \text{ volts} - (0.25 \text{ Amps} * 4 \text{ HydroCAT-EPs}) * (0.0107 \text{ ohms/foot} * 2 * \text{cable length}) \geq 9 \text{ volts}$$

$$3 \text{ volts} \geq (0.25 \text{ Amps} * 4 \text{ HydroCAT-EPs}) * (0.0107 \text{ ohms/foot} * 2 * \text{cable length})$$

$$\text{Cable length} \leq 140 \text{ ft} = 42 \text{ meters (to HydroCAT-EP furthest from power source)}$$

Section 3: Preparing HydroCAT-EP for Deployment

This section describes the pre-check procedure for preparing the HydroCAT-EP for deployment. Installation of the battery pack, installation of Sea-Bird software, and testing power and communications are discussed.

Battery Pack Installation

WARNING!
Do not ship the HydroCAT-EP with battery pack installed. See *Shipping Precautions* in *Section 1: Introduction*.

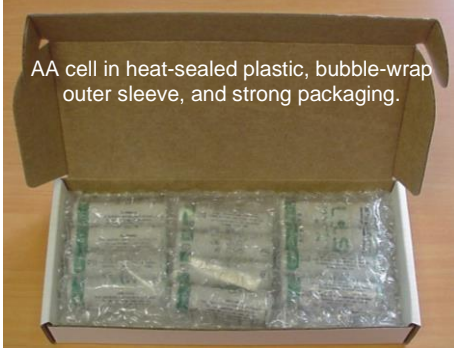

CAUTION:
See *Section 5: Routine Maintenance and Calibration* for handling instructions for the plastic housing.

Description of Cells and Battery Pack

Sea-Bird supplies twelve 3.6-volt AA lithium cells, shipped with the HydroCAT-EP in a heat-sealed plastic bag placed in bubble wrap and a cardboard box. The empty cell holder is installed inside the HydroCAT-EP for shipment.

No soldering is required when assembling the battery pack.

Installing Cells and Battery Pack

1. Remove the connector end cap:
 - A. Wipe the outside of the end cap and housing dry, being careful to remove any water at the seam between them.
 - B. Remove the 2 cap screws on the sides of the housing. Do not remove any other screws.
Note: Sea-Bird ships the HydroCAT-EP with a 9/64-inch Allen wrench for these screws.
 - C. Remove the I/O end cap by twisting the end cap counter clockwise; the end cap will release from the housing. Pull the end cap out.
 - D. The end cap is electrically connected to the electronics with a Molex connector. Holding the wire cluster near the connector, pull gently to detach the female end of the connector from the pins.
 - E. Remove any water from the O-ring mating surfaces inside the housing with a lint-free cloth or tissue.
 - F. Put the end cap aside, being careful to protect the O-rings from damage or contamination.

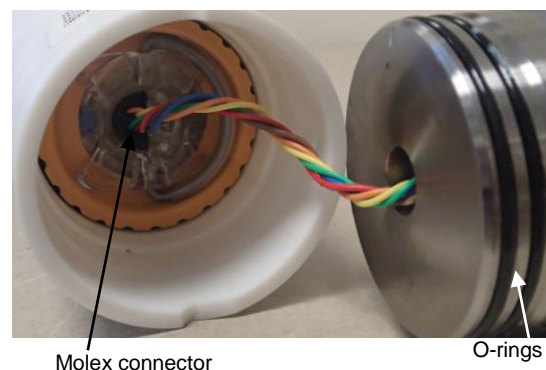
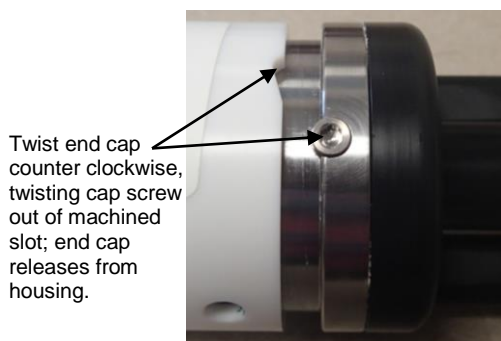
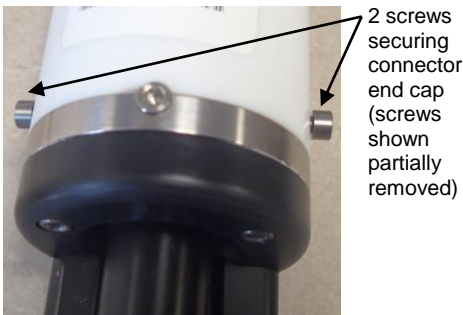

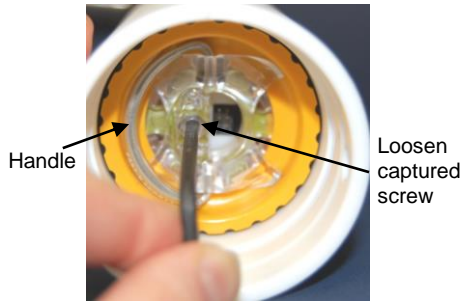

Remove the battery pack assembly from the housing:

- A. Loosen the captured screw from the battery pack cover plate, using the 7/64-inch Allen wrench (supplied).
- B. Lift the battery pack assembly straight out of the housing, using the handle.

3. Keep the handle in an upright position. Holding the edge of the yellow cover plate, unscrew the cover plate from the battery pack assembly.

4. Roll the 2 O-rings on the outside of the battery pack out of their grooves.

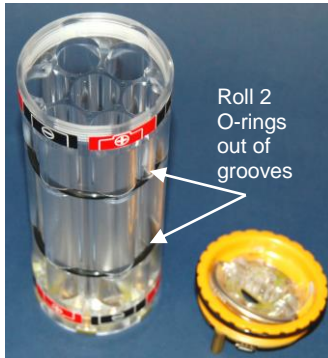

5. Insert each cell into the pack, **alternating** positive (+) end first and negative (-) end first to match the labels on the pack.

6. Roll the 2 O-rings on the outside of the battery pack into place in the grooves. The O-rings compress the side of the battery pack and hold the cells tightly in place in the pack.

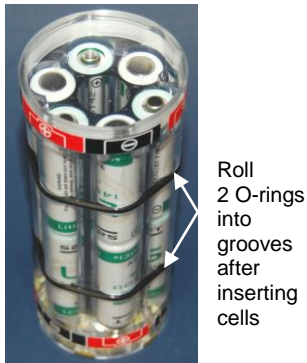

7. Reinstall the battery pack cover plate:

- A. Align the pin on the battery pack cover plate PCB with the post hole in the battery pack housing.
- B. Place the handle in an upright position. Screw the yellow cover plate onto the battery pack assembly. Ensure the cover is tightly screwed on to provide a reliable electrical contact.

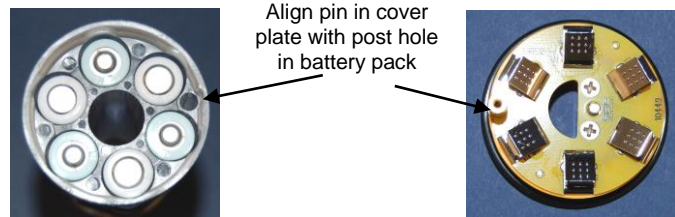

8. Replace the battery pack assembly in the housing:

- A. Align the D-shaped opening in the cover plate with the pins on the shaft. Lower the assembly slowly into the housing, and once aligned, push gently to mate the banana plugs on the battery compartment bulkhead with the lower PCB. A post at the bottom of the battery compartment mates with a hole in the battery pack's lower PCB to prevent improper alignment.
- B. Secure the assembly to the shaft with the captured screw, using the 7/64-inch Allen wrench. Ensure the screw is tight to provide a reliable electrical contact.

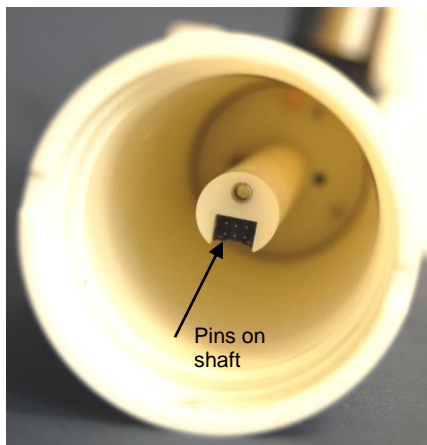

9. Reinstall the connector end cap:

- A. Remove any water from the O-rings and mating surfaces in the housing with a lint-free cloth or tissue. Inspect the O-rings and mating surfaces for dirt, nicks, and cuts. Clean as necessary. Apply a light coat of O-ring lubricant (Parker Super O Lube) to the O-rings and mating surfaces.
- B. Plug the female end of the Molex connector onto the pins.
- C. Carefully fit the end cap into the housing until the O-rings are fully seated.
- D. Reinstall the 2 cap screws to secure the end cap.

CAUTION:
Do not use Parker O-Lube, which is petroleum based; use only Super O-Lube.

Software Installation

Notes:

- Help files provide detailed information on the software.
- It is possible to communicate with the HydroCAT-EP without the referenced software by sending direct commands from a dumb terminal or terminal emulator, such as Windows HyperTerminal.
- Sea-Bird supplies the current version of our software when you purchase an instrument. As software revisions occur, we post the revised software. See our website (www.seabird.com) for the latest software version number, a description of the software changes, and instructions for downloading the software.

The **Universal Coastal Interface (UCI)** software was included on the CD that shipped with your HydroCAT-EP. UCI is designed to set up the HydroCAT-EP, run validation checks, upload data, and plot data. The UCI manual covers installation and use of this software in detail.

If you will be using a USB-to-Serial Port adapter to connect the HydroCAT-EP to a USB port on your computer: You must install the driver for the adapter. The driver should have been provided when you purchased the adapter, or you should be able to download it from the adapter manufacturer's website.

Power and Communications Test

The power and communications test will verify that the system works, prior to deployment.

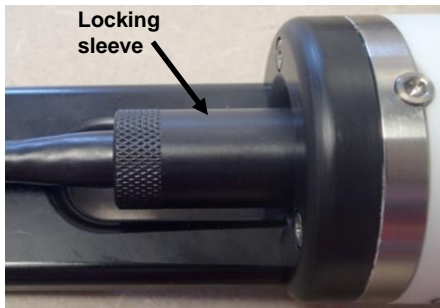
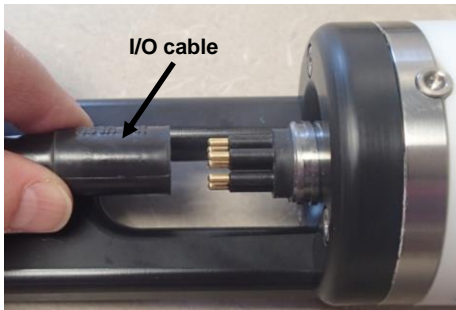

Test Setup

1. Remove dummy plug (if applicable):
 - A. By hand, unscrew the locking sleeve from the HydroCAT-EP's bulkhead connector. If you must use a wrench or pliers, be careful not to loosen the bulkhead connector instead of the locking sleeve.
 - B. Remove the dummy plug from the HydroCAT-EP's I/O bulkhead connector by pulling the plug firmly away from the connector.
2. Install the I/O cable connector, aligning the pins.
3. Connect the I/O cable connector to your computer's serial port.

Test

1. Open the UCI software.
2. On the UCI Dashboard, click **Connect**.
3. In the Connect dialog box: select HydroCAT-EP as the Instrument Type, enter the baud rate (default 19200). Click *Try All Baud Rates*; UCI will cycle through all available baud rates if it cannot connect at the entered baud rate. Select the COM port. Click **Connect**. On the HydroCAT Dashboard, the Connection Mode shows **Transition** on a yellow background, and then shows **Setup** on a green background when the connection is established.
4. On the HydroCAT Dashboard, click **HydroCAT-EP Settings**. In the HydroCAT-EP Settings dialog box, make the desired selections on each tab:

Notes:

- The **Default** button in the HydroCAT-EP Settings dialog sets the units and output parameters to those typical for coastal applications: output temperature (°C), pressure (dbar), specific conductivity (µS/cm), oxygen (mg/L), pH, fluorescence (always µg/L), turbidity (always NTU).
- If the Minimum Conductivity Frequency is too close to the *Zero Conductivity Frequency* (from the HydroCAT-EP Calibration Sheet), the pump may turn on when the HydroCAT-EP is in air, as a result of small drifts in the electronics. Some experimentation may be required to control the pump, particularly in fresh water applications.

- **Output Format** - Parameters to be output and output units (unit selection for Conductivity also applies to Specific Conductivity). All data (conductivity, temperature, pressure, oxygen, pH, fluorescence, turbidity, time) is stored in the HydroCAT-EP memory in raw format, regardless of selections made here; these selections just affect the data output format for real-time or uploaded data.
- **Data** - (for autonomous sampling) Interval between samples (sec) and whether to transmit data in real-time (data is always stored in memory).
- **Pumping** - Minimum Conductivity Frequency (Hz) to enable pump turn-on, to prevent pump from running before the HydroCAT-EP is in water. Pump does not run when conductivity frequency drops below this value. The HydroCAT-EP Calibration Sheet lists the uncorrected (raw) frequency output at 0 conductivity (also called the Zero Conductivity Frequency).
 - **Fresh Water** applications: Typical Minimum Conductivity Frequency is (Zero Conductivity Frequency + 1 Hz). *Default factory setting.*
 - **Salt Water and Estuarine** Applications: Typical Minimum Conductivity Frequency is (Zero Conductivity Frequency + 500 Hz).
- **Baud Rate** - UCI will automatically reconnect at this baud rate when you click **Apply**.

To save any new settings, click **Apply** when you are done.

Note:

The HydroCAT-EP automatically enters quiescent (sleep) state after 2 minutes without receiving a command. This timeout algorithm is designed to conserve battery pack energy.

5. Click **Start**; the Connection Mode shows **Acquisition** on a green background. The HydroCAT-EP will start logging data at the sample interval specified in the HydroCAT-EP Settings dialog. The real-time data appears in the Real Time Display, in the Time Series plot, and in the Output – Instrument Console. These numbers should be reasonable; i.e., room temperature, zero conductivity, barometric pressure (gauge pressure), current date and time (shipped from the factory set to Pacific Daylight or Standard Time).

The HydroCAT-EP is ready for programming and deployment.

Section 4:

Deploying and Operating HydroCAT-EP

This section includes:

- system operation with example setups
- baud rate and cable length considerations
- timeout description
- data output formats
- optimizing data quality
- deploying and recovering HydroCAT-EP
- uploading and processing data from HydroCAT-EP's memory

Sampling Modes

The HydroCAT-EP has two basic sampling modes for obtaining data:

- **Polled Sampling** – On command, the HydroCAT-EP runs the pump, takes one sample, and transmits data. Alternatively, the HydroCAT-EP can be commanded to transmit the last sample in its memory while it is sampling autonomously. Polled sampling is useful for integrating the HydroCAT-EP with satellite, radio, or wire telemetry equipment. Polled sampling can be accomplished via the HydroCAT-EP RS-232 interface or the SDI-12 interface.
- **Autonomous Sampling** (not compatible with SDI-12 deployments) – At pre-programmed intervals, the HydroCAT-EP wakes up, runs the pump, samples, stores data in memory, and goes to sleep. Data can be transmitted real-time (set real-time output in HydroCAT-EP Settings dialog box).

Output parameters and units can be used in various combinations to provide a high degree of operating flexibility.

Note:

The pump runs only if the conductivity frequency from the last sample was greater than the Minimum Conductivity Frequency for running the pump (set in the HydroCAT-EP Settings dialog box). Checking the conductivity frequency prevents the pump from running in air for long periods of time, which could damage the pump.

The integral pump runs before every sample measurement. The pump flushes the previously sampled water from the conductivity cell and oxygen plenum and brings a new water sample quickly into the system. Water does not freely flow through the plumbing between samples, minimizing fouling. See *Pump Operation* in *Section 2: Description of HydroCAT-EP* for details.

- Dissolved oxygen sensor **not** installed – Pump runs for 1.0 second before each sample.
- Dissolved oxygen sensor installed – The pump runs for a user-programmable time (or a multiple of oxygen sensor response time).

Descriptions and examples of the sampling modes follow. Review the operation of the basic sampling modes before setting up your system.

Polled Sampling

On command, the HydroCAT-EP takes a measurement and sends the data to the computer. Storing of data in the HydroCAT-EP's FLASH memory is dependent on the particular command used. Polled sampling commands can be sent in two ways:

- Via RS-232 in a terminal program – see *Appendix III: Command Summary and Details* for a list of commands and descriptions. Note that many of the commands listed in the *Appendix* can be more easily sent via the UCI.
- Via SDI-12 – see *Command Descriptions and Data Output Format – Transmission via SDI-12* in this section. **Note that the HydroCAT-EP must be externally powered when communicating via SDI-12.**

For polled sampling commands that run the pump, the HydroCAT-EP checks if the conductivity frequency from the last sample was greater than the Minimum Conductivity Frequency before running the pump.

Example: Polled Sampling using SDI-12 Interface

Connect to HydroCAT-EP via UCI. Set up to include temperature (°C), specific conductivity (µS/cm), pressure (psi), oxygen (mg/L), pH, fluorescence (µg/L), and turbidity (NTU) with data, set the SDI-12 address for this HydroCAT, and set it to operate in Polled Sampling mode.

1. Click **Connect** in UCI. In dialog box, select HydroCAT-EP, baud rate, and Port, and click Try All Baud Rates. Click **Connect**. Connection Mode shows **Transition** and then shows **Setup**.
2. Click **HydroCAT-EP Settings**:
 - A. On Output Format tab, select the desired output parameters and units (note that units for Conductivity also apply to Specific Conductivity).
 - B. On Pumping tab, verify that Minimum Conductivity Frequency is appropriate for your application.
 - C. Click **Apply** to send settings to HydroCAT-EP.
3. Click **Command Terminal**.
 - A. In the Terminal Window, type **SetAddress=x** (where **x** is address [0-9, a-z, A-Z] for SDI-12 communications), and click **Submit**.
 - B. In the Terminal Window, select Get Configuration Data (**GetCD**) and click **Submit** to verify setup.
 - C. In the Terminal Window, select Get Calibration Coefficients (**GetCC**) and click **Submit** to verify setup.
 - D. Close the Terminal Window.
4. Click **Deployment Wizard**.
 - A. In Step 1, select Polled Sampling (SDI-12).
 - B. In Step 3, select Synchronize HydroCAT clock to computer to update the clock. If you previously uploaded any data in memory, select Clear HydroCAT data to make the full memory available for recording.
 - C. In Step 4, enter the desired file name and location for the Deployment Report.
 - D. Click **Finish**. UCI automatically disconnects from the HydroCAT-EP.

When ready to take a sample (repeat as desired): provide external power to HydroCAT-EP, connect to HydroCAT-EP via SDI-12, command it to take a sample and store data in memory, and command it to output data.

Break

(wake all HydroCAT-EPs on line)

aM! (where 'a' is SDI-12 address)

(take sample; store data in memory and in buffer)

aD0! (where 'a' is SDI-12 address)

(send data from HydroCAT-EP buffer)

Autonomous Sampling (Logging commands)

Notes:

- Autonomous sampling is not compatible with SDI-12 operation.
- If the FLASH memory is filled to capacity, sampling continues, but excess data is not saved in memory (i.e., the HydroCAT-EP does not overwrite the data in memory).

At pre-programmed intervals the HydroCAT-EP wakes up, runs the pump (if the conductivity frequency from the last sample was greater than Minimum Conductivity Frequency), samples data, stores the data in its FLASH memory, and goes to sleep (enters quiescent state). Transmission of real-time data to the computer is dependent on the Transmit Real Time setting.

If transmitting real-time data, keep the signal line open circuit or within ± 0.3 V relative to ground to minimize power consumption when not trying to send commands.

Example: Autonomous Sampling

Connect to HydroCAT-EP via UCI. Set up to include temperature ($^{\circ}\text{C}$), specific conductivity ($\mu\text{S}/\text{cm}$), pressure (psi), oxygen (mg/L), pH, fluorescence ($\mu\text{g}/\text{L}$), and turbidity (NTU) with data, and set it to operate in Autonomous Sampling mode.

1. Click **Connect** in UCI. In dialog box, select HydroCAT-EP, baud rate, and Port, and click Try All Baud Rates. Click **Connect**. Connection Mode shows **Transition** and then shows **Setup**.
2. Click **HydroCAT-EP Settings**:
 - A. On Output Format tab, select the desired output parameters and units (note that units for Conductivity also apply to Specific Conductivity).
 - B. On Data tab, set the desired sample interval and (if desired) click Transmit Real Time.
 - C. On Pumping tab, verify that Minimum Conductivity Frequency is appropriate for your application.
 - D. On Baud Rate tab, (if desired) change the baud rate to be used for the deployment.
 - E. Click **Apply** to send settings to HydroCAT-EP.
3. Click **Command Terminal**.
 - A. In the Terminal Window, select Get Configuration Data (**GetCD**) and click **Submit** to verify setup.
 - B. In the Terminal Window, select Get Calibration Coefficients (**GetCC**) and click **Submit** to verify setup.
 - C. Close the Terminal Window.
4. Click **Start**. You will see the real time data in UCI's Real Time Display as well as in the Output – Instrument Console. Click **Stop**. If the data looks correct, you are ready to deploy the HydroCAT-EP.
5. Click **Deployment Wizard**.
 - A. In Step 1, select Autonomous Sampling.
 - B. In Step 2, select the date and time to start sampling data. If desired, change the Sample Interval (which you set in the HydroCAT-EP Settings dialog).
 - C. In Step 3, select Synchronize HydroCAT clock to computer to update the clock. If you previously uploaded any data in memory, select Clear HydroCAT data to make the full memory available for recording.
 - D. In Step 4, enter the desired file name and location for the Deployment Report.
 - E. Click **Finish**. UCI automatically disconnects from the HydroCAT-EP.

HydroCAT-EP will automatically wake up and go to sleep for each sample. **Note that you cannot view real-time data in UCI (because UCI will automatically stop the logging when you reconnect). However, if desired, you can view real-time data in a terminal program if you set it to output real-time data in HydroCAT-EP Settings dialog.**

RS-232 Real-Time Data Acquisition

Notes:

- RS-232 baud rate is set on the Baud Rate tab of the HydroCAT-EP Settings dialog.
- If using external power, see *External Power* in *Section 2: Description of HydroCAT-EP* for power limitations on cable length.

The length of cable that the HydroCAT-EP can drive when communicating via **RS-232** is dependent on the baud rate. The allowable combinations are:

Maximum Cable Length (meters)	Maximum Baud Rate
200	4800
100	9600
50	19200
25	38400
16	57600
8	115200

Check the capability of your computer and terminal program before increasing the baud; high baud requires a short cable and good PC serial port with an accurate clock.

Timeout Description

The HydroCAT-EP has a timeout algorithm. If the HydroCAT-EP does not receive a command for 2 minutes, it powers down its communication circuits to prevent exhaustion of the battery pack. This places the HydroCAT-EP in quiescent state, drawing minimal current.

Command Descriptions – Transmission via RS-232

UCI software is used to easily communicate with and set up the HydroCAT-EP, and upload and plot data. See *Appendix III: RS-232 Command Summary and Details* for customers who want access to the full list of commands that can be sent to the HydroCAT-EP via a terminal program (such as **Command Terminal** available in UCI).

Command Descriptions and Data Output Format – Transmission via SDI-12

Note that the HydroCAT-EP must be externally powered when communicating via SDI-12.

All SDI-12 commands:

- Are case sensitive.
- Are terminated with ‘!’ (except as noted).
- Start with SDI-12 address, designated as ‘a’ in command descriptions below (0-9, a-z, A-Z).

All SDI-12 command responses:

- Are terminated with <CR><LF> (except as noted).

SDI-12 Standard Commands

Break

Command	Response	Description
Break	None; initiate search for valid mark.	12 millisecc spacing on line - Wake all HydroCAT-EPs on line. <i>Note:</i> ‘!’ command termination and <CR><LF> do not apply.

Acknowledge Active

Command	Response	Description
a!	a <CR><LF>	Check that HydroCAT-EP ‘a’ is responding.

Send Identification

Command	Response	Description
a!	Allccccccmmmmmvvnnnnn oooooo<CR><LF> <i>where</i> ll = SDI-12 version compatibility (13 = 1.3) cccccc = vendor ID (‘SeaBird ’) mmmmm = Instrument name (‘HCEP ’) vvv = HydroCAT-EP firmware version (‘500’) nnnnn = HydroCAT-EP serial number oooooo= up to 8 characters, designation of optional sensors (P if pressure installed, O if oxygen installed, FN if HCO installed) <i>Example string when HydroCAT-EP’s SDI-12 address is 0, serial number is HCEP-32345, and pressure, oxygen, and HCO sensors installed:</i> 013SeaBird HCEP 50032345POFN	Identify instrument. <i>Notes:</i> • Serial number is last 5 characters of serial number. • Firmware version in a! response is limited to number of characters shown, including decimal point. Use aXV! (see SDI-12 Extended Commands) to get full firmware version. For example: - For firmware 5.0.0, a! returns ‘500’, while aXV! returns ‘5.0.0’. - For firmware 5.11.0, a! returns ‘511’, while aXV! returns ‘5.11.0’.

Note:
For firmware version x.y.z:
• x = major version (1-digit number in a! response)
• y = minor version (2-digit number in a! response)
• z = micro version (not included in a! response)
For example, if the firmware version is 5.1.0, a! shows it as 501, where 5 is the major version and 01 is the minor version.

SDI-12 Address Query

Command	Response	Description
?!	a<CR><LF>	Get HydroCAT-EP’s SDI-12 address; valid only if just 1 HydroCAT-EP online.

Change SDI-12 Address

Command	Response	Description
aAb!	b<CR><LF>	Change HydroCAT-EP’s SDI-12 address from ‘a’ to ‘b’.

Start Measurement TPSS (run pump; store data in FLASH memory)

Command	Response	Description
aM!	atttn<CR><LF> <i>(followed by)</i> a<CR><LF> <i>(when data is ready)</i>	Send TPSS to HydroCAT-EP (run pump, take sample, store data in buffer, store data in FLASH memory for later upload). Hold results in HydroCAT-EP buffer until another sample taken. Service request issued when data ready.
aMC!	Same as aM!	Same as aM!, but result in buffer includes 3-character checksum before <CR><LF>.
aC!	atttnn<CR><LF>	Same as aM!, but service request (a<CF><LF>) not sent.
aCC!	Same as aC2!	Same as aC!, but result in buffer includes 3-character checksum before <CR><LF>.

Start Measurement TPS (run pump; do **not** store data in FLASH memory)

Command	Response	Description
aM1!	atttn<CR><LF> <i>(followed by)</i> a<CR><LF> <i>(when data is ready)</i>	Send TPS to HydroCAT-EP (run pump, take sample, store data in buffer). Hold results in HydroCAT-EP buffer until another sample taken. Service request issued when data ready.
aMC1!	Same as aM1!	Same as aM1!, but result in buffer includes 3-character checksum before <CR><LF>.
aC1!	atttnn<CR><LF>	Same as aM1!, but service request (a<CF><LF>) not sent.
aCC1!	Same as aC1!	Same as aC1!, but result in buffer includes 3-character checksum before <CR><LF>.

Start Measurement TS (do **not** run pump or store data in FLASH memory)

Command	Response	Description
aM2!	atttn<CR><LF> <i>(followed by)</i> a<CR><LF> <i>(when data is ready)</i>	Send TS to HydroCAT-EP (do not run pump ; take sample, store data in buffer). Hold results in HydroCAT-EP buffer until another sample taken. Service request issued when data ready.
aMC2!	Same as aM2!	Same as aM2!, but result in buffer includes 3-character checksum before <CR><LF>.
aC2!	atttnn<CR><LF>	Same as aM2!, but service request (a<CF><LF>) not sent.
aCC2!	Same as aC2!	Same as aC2!, but result in buffer includes 3-character checksum before <CR><LF>.

Send Data

Command	Response	Description
aD0!	a<values><CRC><CR><LF> <i>where</i> <values> = parameters in data string <i>(see Note at left for data that is included in string)</i> CRC is sent if Start Measurement command included CRC request (aMC!, aMC1!, aCC!, aCC1!, etc.)	Send data from HydroCAT-EP buffer. If string is too long, additional commands (aD1!, aD2!, etc.) required to retrieve remaining data. Number of characters in values plus CRC string is limited to 75 for Concurrent data (sampling command string starts with 'C'), or 35 for non-Concurrent data (sampling command string starts with 'M').

Note:

Responses to Start Measurement commands include:

- a = SDI-12 address
- ttt = maximum amount of time (sec) until data is ready
- n (1 digit, for M commands) is number of parameters in data string. **Output is always the following parameters, regardless of which outputs are disabled in UCI or with an RS-232 command** – temperature, pressure (if installed), dissolved oxygen (if installed), pH, fluorescence and turbidity (if installed), specific conductivity, percent oxygen saturation (if oxygen installed), and main power voltage.
- nn (2 digits, for C [Concurrent] commands) = number of parameters in data string. **Output is always the following parameters, regardless of which outputs are disabled in UCI or with an RS-232 command** - temperature, conductivity, pressure (if installed), dissolved oxygen (if installed), pH, fluorescence and turbidity (if installed), fluorescence and turbidity standard deviations (if installed), salinity, sound velocity, specific conductivity, percent oxygen saturation (if oxygen installed), main power voltage, sample number, and error flag.

SDI-12 Extended Commands

The following commands, defined by an 'X', make it possible to perform common setup changes in the field without connecting to a computer:

Command	Response	Description
aXV!	av.v.v, mmm dd yyyy hh:mm:ss <CR><LF> <i>where</i> v.v.v = firmware version (5.0.0) mm dd yyyy hh:mm:ss = firmware date and time	Get full HydroCAT-EP firmware version string (firmware version and firmware date and time).
aXPx!	ax<CR><LF>	Send PumpOn (1) or PumpOff (0) . Turn pump on to test or remove sediment; runs continuously, drawing current. (pump turns off when PumpOff sent or 2 minutes without communications have elapsed)
aXMCfx!	ax<CR><LF>	Send MinCondFreq=x ; range 0 – 5000. Minimum Conductivity Frequency (Hz) to enable pump turn-on, to prevent pump from running in air. Configuration Sheet lists frequency output at 0 conductivity. Typical MinCondFreq values: fresh water: (0 conductivity frequency + 1). salt water & estuarine: (0 conductivity frequency + 500).
aXMR0!	n<CR><LF> <i>Notes:</i> Must send twice to prevent accidental reset of memory. Response to first command shows current sample number n (number of samples in memory). Response to second command shows sample number n reset to 0.	Send InitLogging . After all data has been uploaded , initialize logging to make entire memory available for recording. If not initialized, data is stored after last sample. HydroCAT-EP requires command to be sent twice, to prevent accidental reset.
aXUTx!	ax<CR><LF>	Send SetTempUnits=x . x=0 : Temperature °C, ITS-90. x=1 : °F, ITS-90.
aXUCx!	ax<CR><LF>	Send SetCondUnits=x . x=0 : Conductivity S/m. x=1 : mS/cm. x=2 : µS/cm.
aXUPx!	ax<CR><LF>	Send SetPressUnits=x . x=0 : Pressure decibars. x=1 : psi (gauge).
aXUOx!	ax<CR><LF>	Send SetOxUnits=x . x=0 : Oxygen ml/L. x=1 : mg/L.

Note:

For all extended commands with an argument (x): If the argument is omitted, the response provides the current setting.

SDI-12 Data Format

The **identification string** (a!) for SDI-12 is:

a<ll><Vendor ID><Instrument name><Firmware version><Serial Number><Optional Sensors>
where

Note:

For firmware version x.y.z:

- x = major version (1-digit number in a! response)
- y = minor version (2-digit number in a! response)
- z = micro version (not included in a! response)

For example, if the firmware version is 5.1.0, a! shows it as 501, where 5 is the major version and 01 is the minor version.

- a = SDI=12 address
- ll = SDI-12 version compatibility (13 = 1.3)
- Vendor ID = 8 characters ('SeaBird' for Sea-Bird instruments)
- Instrument name = 6 characters ('HCEP' for this HydroCAT-EP)
- Firmware version = 3 characters (vvv); use aXV! to get the full firmware version. For example:
 - For firmware 5.0.0, a! returns '500', while aXV! returns '5.0.0'.
 - For firmware 5.1.0, a! returns '501' while aXV! returns '5.1.0'.
 - For firmware 5.11.0, a! returns '511', while aXV! returns '5.11.0'.
- Serial number = last 5 characters of HydroCAT-EP serial number (nnnnn)
- Optional Sensors = up to 8 characters
(P = pressure sensor installed; O = dissolved oxygen sensor installed; FN = HCO [chlorophyll and turbidity] sensor installed.)
Additional characters available for future products.

Example: Identification string for HydroCAT-EP with SDI-12 address 0, when HydroCAT-EP's serial number is HCEP32345 and pressure, oxygen, and HCO sensors installed:

013SeaBird HCEP 50032345POFN

Notes:

- In UCI, click **HydroCAT-EP Settings** to set data output units and enable output of desired parameters.
- HydroCAT-EP automatically outputs in this format over the SDI-12 line. If viewing data via an RS-232 terminal program, set **OutputFormat=3** to emulate this data format.
- The HydroCAT-EP's pressure sensor is an absolute sensor, so its **raw** output (**OutputFormat=0**) includes the effect of atmospheric pressure (14.7 psi). As shown on the Calibration Sheet, Sea-Bird's calibration (and resulting calibration coefficients) is in terms of psia. However, when outputting pressure in **psi** or **decibars**, the HydroCAT-EP outputs pressure relative to the ocean surface (i.e., at the surface the output pressure is 0 psi or 0 dbar).
The HydroCAT-EP uses the following equations to convert psia:
P (psi) = P (psia) - 14.7
P (dbar) = [P (psia) - 14.7] * 0.689476

The **converted decimal data format** for SDI-12 for a C command is:

a+ttt.tttt+c+ppp.pppp+oo.ooo+p.pp+ff.fff+tt.ttt+sdf+sdt
+sss.ssss+vvvv.vvv+x+ss.ss+v.v+n+flag

where

- a = SDI=12 address
- (+ or -) sign precedes each parameter
- ttt.tttt = temperature; °C or °F.
- c = conductivity.
cc.cccc if conductivity units set to S/m.
ccc.cccc if conductivity units set to mS/cm.
cccc.c if conductivity units set to µS/cm.
- pppp.ppp = pressure; sent if pressure sensor installed; dbar or psi.
- oo.ooo = oxygen; sent if oxygen sensor installed; ml/L or mg/L.
- p.pp = pH.
- ff.fff = fluorescence; sent if HCO installed; µg/L.
- tt.ttt = turbidity; sent if HCO installed; NTU.
- sdf = fluorescence standard deviation; sent if HCO installed; µg/L.
- sdt = turbidity standard deviation; sent if HCO installed; NTU.
- sss.ssss = salinity; psu.
- vvvv.vvv = sound velocity; m/sec.
- x = specific conductivity.
xx.xxxxx if conductivity units set to S/m .
xxx.xxxx if conductivity units set to mS/cm.
xxxxx.x if conductivity units set to µS/cm.
- ss.ss = percent oxygen saturation; sent if oxygen sensor installed; %.
Note: See Calculation of Oxygen Saturation in Appendix III: RS-232 Command Summary and Details for algorithm.
- v.v = main power supply voltage (internal battery pack or external power, as applicable). Not stored in memory.
- n = sample number in FLASH memory.
Note: If using polled sampling command that does not store data in FLASH memory, value is '-1'.
- flag = error flag;
0 = good, 1 = low battery, 2 = did not take 30 HCO measurements,
4 = HCO wiper position error, 8 = oxygen sensor error,
16 = HCO not sampled, 32 = pump stalled, 64 = pH not sampled;
other numbers combination of flags
(for example, 65 = 1 [low battery] and 64 [pH not sampled])

The **converted decimal data format** for SDI-12 for an **M command** is:

a+ttt.tttt+ppp.pppp+oo.ooo+p.pp+ff.fff+tt.ttt+x+ss.ss+v.v
where

- a = SDI=12 address
- (+ or -) sign precedes each parameter
- ttt.tttt = temperature; °C or °F.
- pppp.ppp = pressure; sent if pressure sensor installed; dbar or psi.
- oo.ooo = oxygen; sent if oxygen sensor installed; ml/L or mg/L.
- p.pp = pH.
- ff.fff =fluorescence; sent if HCO installed; µg/L.
- tt.ttt = turbidity; sent if HCO installed; NTU.
- x = specific conductivity.
xx.xxxxx if conductivity units set to S/m .
xxx.xxxx if conductivity units set to mS/cm.
xxxxx.x if conductivity units set to µS/cm.
- ss.ss = percent oxygen saturation; sent if oxygen sensor installed; %.
Note: See Calculation of Oxygen Saturation in Appendix III: RS-232 Command Summary and Details for algorithm.
- v.v = main power supply voltage (internal battery pack or external power, as applicable). Not stored in memory.

Note the following:

- Polarity sign is always sent.
- Decimal point is optional.
- Maximum digits for a value is 7, even without a decimal point.
- Minimum digits for a value is 1.
- Maximum characters in data value is 9 (sign, 7 digits, decimal point).
- Leading zeros are suppressed, except for one zero to left of decimal point.

Example: Sample data output when all optional sensors installed:

From C command:

0C!004416<CR><LF>

0D0!0+23.4563+0.0005-0.084+8.054+7.51-0.097+3.409+1.14+0.55+0.0113+1492.497<CR><LF>

0D1!0+0.0006+95.00+13.8+1+0<CR><LF>

(SDI-12 address, temperature, conductivity, pressure, oxygen, pH, fluorescence, turbidity, fluorescence standard deviation, turbidity standard deviation, salinity, sound velocity, specific conductivity, % oxygen saturation, main power supply voltage, sample number, error flag)

From M command:

0M!00449<CR><LF>

0<CR><LF>

0D0!0+23.4679-0.085+8.057+7.50-0.104<CR><LF>

0D1!0+3.504+0.0009+95.03+13.8<CR><LF>

(SDI-12 address, temperature, pressure, oxygen, pH, fluorescence, turbidity, specific conductivity, % oxygen saturation, main power supply voltage)

RS-232 Data Formats

Notes:

- You can set the desired RS-232 output format (**OutputFormat=**) in an RS-232 terminal program.
- In UCI, click **HydroCAT-EP Settings** to set data output units and enable output of desired parameters (or see *Appendix III* for the commands to send via an RS-232 terminal program).
- Time is the time at the **start** of the sample.
- When real-time output is enabled, real-time autonomous data transmitted via **RS-232** is preceded by a # sign.
- The HydroCAT-EP's pressure sensor is an absolute sensor, so its **raw** output (**OutputFormat=0**) includes the effect of atmospheric pressure (14.7 psi). As shown on the Calibration Sheet, Sea-Bird's calibration (and resulting calibration coefficients) is in terms of psia. However, when outputting pressure in **psi** or **decibars**, the HydroCAT-EP outputs pressure relative to the ocean surface (i.e., at the surface the output pressure is 0 psi or 0 dbar). The HydroCAT-EP uses the following equations to convert psia:

$$P(\text{psi}) = P(\text{psia}) - 14.7$$

$$P(\text{dbar}) = [P(\text{psia}) - 14.7] * 0.689476$$

Defined below are the HydroCAT-EP's RS-232 output data formats. Each scan ends with a carriage return <CR> and line feed <LF>.

- OutputFormat=0:** raw decimal data, for diagnostic use at Sea-Bird HCEP037nnnnn,tttttt, cccc.ccc, ppppppp, vvvvv, oo.ooo, t.ttttt, pppppppp, fl0, fl1, fl2, tbd0, tbd1, tbd2, sdf1, sdf2, sdf3, sdt1, sdt2, sdt3, dd mmm yyyy, hh:mm:ss, flag

where

- HCEP037nnnnn = instrument ID (HCEP) and serial number (037nnnnn)
- tttttt = temperature A/D counts.
- cccc.ccc = conductivity frequency (Hz).
- ppppppp = pressure sensor pressure A/D counts; sent if pressure sensor installed.
- vvvvv = pressure sensor pressure temperature compensation A/D counts; sent if pressure sensor installed.
- oo.ooo = oxygen sensor phase (µsec); sent if oxygen sensor installed.
- t.ttttt = oxygen sensor temperature voltage.
- ppppppppp = ± pH A/D counts.
- fl0, fl1, fl2 = fluorescence counts (average of 30 measurements) at 3 different gain settings (1, 5, and 25); maximum 5 digits each; sent if HCO installed.
- tbd0, tbd1, tbd2 = turbidity counts (average of 30 measurements) at 3 different gain settings (1, 5, and 25); maximum 5 digits each; sent if HCO installed.
- sdf1, sdf2, sdf3 = standard deviation of fluorescence corresponding to fl0, fl1, and fl2 respectively, to two decimal places; sent if HCO installed and output enabled.
- sdt1, sdt2, sdt3 = standard deviation of turbidity corresponding to tbd0, tbd1, and tbd2 respectively, to two decimal places; sent if HCO installed and output enabled.
- dd mmm yyyy = day, month, year.
- hh:mm:ss = hour, minute, second.
- flag = error flag;
 0 = good, 1 = low battery, 2 = did not take 30 HCO measurements, 4 = HCO wiper position error, 8 = oxygen sensor error, 16 = HCO not sampled, 32 = pump stalled, 64 = pH not sampled; other numbers combination of flags
 (for example, 65 = 1 [low battery] and 64 [pH not sampled])

Most data is separated with a comma and a space; there is no space before the temperature output. Each field is filled out with spaces if it does not use the maximum number of digits.

Salinity, sound velocity, specific conductivity, percent oxygen saturation, and sample number are not sent, regardless of settings for those parameters.

Example: Sample data output when all optional sensors installed and **OutputFormat=0**:

```
HCEP03730078, 224598, 2410.164, 1807851, 20750, 16.729, 0.594629, 122368,
488, 2265, 10730, 16014, 16242, 16343, 1.48, 7.55, 27.81, 6.33, 0.38,
0.00, 21 Sep 2015, 13:45:50, 0
(instrument ID and serial number, temperature, conductivity, pressure sensor pressure, pressure sensor
temperature compensation, oxygen phase, oxygen temperature voltage, pH, 3 fluorescence averages, 3 turbidity
averages, 3 fluorescence standard deviations, 3 turbidity standard deviations, date, time, error flag)
```

- **OutputFormat=1:** converted decimal data
HCEP037nnnnn, tttt.tttt, c, ppppp.ppp, ooo.ooo, p.pp, ffff.fff, tttt.ttt, sdf, sdt, ssss.ssss, vvvvv.vvv, x, ss.ss, dd mmm yyyy, hh:mm:ss, n, flag

where

- HCEP037nnnnn = instrument ID (HCEP) and serial number (037nnnnn)
- tttt.tttt = temperature; sent if temperature output enabled; °C or °F.
- c = conductivity; sent if conductivity output enabled.
ccc.ccccc if conductivity units set to S/m.
cccc.cccc if conductivity units set to mS/cm.
cccccc.c if conductivity units set to µS/cm.
- ppppp.ppp = pressure; sent if pressure sensor installed and output enabled; dbar or psi. Number of digits to left of decimal place is dependent on pressure sensor range.
- ooo.ooo = oxygen; sent if oxygen sensor installed and output enabled; ml/L or mg/L.
- p.pp = pH; sent if output enabled.
- ffff.fff = fluorescence (average of 30 measurements); sent if HCO installed and output enabled; µg/L.
*Note: Calculated using highest gain channel with raw value (from **OutputFormat=0**) < 14000.*
- tttt.ttt = turbidity (average of 30 measurements); sent if HCO installed and output enabled; NTU.
*Note: Calculated using highest gain channel with raw value (from **OutputFormat=0**) < 14000.*
- sdf = standard deviation of output fluorescence channel, to two decimal places; sent if HCO installed and output enabled.
- sdt = standard deviation of output turbidity channel, to two decimal places; sent if HCO installed and output enabled.
- ssss.ssss = salinity; psu; sent if output enabled.
- vvvvv.vvv = sound velocity; m/sec; sent if output enabled.
- x = specific conductivity; sent if output enabled.
xxx.xxxxx if conductivity units set to S/m.
xxxx.xxxx if conductivity units set to mS/cm.
xxxxxxx.x if conductivity units set to µS/cm.
- ss.ss = percent oxygen saturation; %; sent if output enabled and oxygen sensor installed.
- dd mmm yyyy = day, month, year.
- hh:mm:ss = hour, minute, second.
- n = sample number in FLASH memory; sent if output enabled, and autonomous sampling or using polled sampling command that stores data in FLASH or retrieves last sample from FLASH.
- flag = error flag;
0 = good, 1 = low battery, 2 = did not take 30 HCO measurements, 4 = HCO wiper position error, 8 = oxygen sensor error, 16 = HCO not sampled, 32 = pump stalled, 64 = pH not sampled; other numbers combination of flags
(for example, 65 = 1 [low battery] and 64 [pH not sampled])

Notes:

- The HydroCAT-EP uses the raw phase delay and raw thermistor voltage from the integrated DO sensor, along with pressure and salinity data from the CTD, to compute and output oxygen in ml/L or mg/L. If the HydroCAT-EP does not include a pressure sensor, it uses the HydroCAT-EP's reference pressure (**ReferencePressure=**) in the pressure correction term of the oxygen equation.
- See *Calculation of Oxygen Saturation in Appendix III: RS-232 Command Summary and Details* for oxygen saturation algorithm.

Leading zeros are suppressed, except one zero to the left of the decimal point. All data is separated with a comma and a space. Each field is filled out with spaces if it does not use the maximum number of digits.

Example: Sample data output for real-time autonomous data transmitted via RS-232 when all optional sensors installed, and outputting all parameters:

```
HCEP03730078, 23.2831, 0.3, -0.058, 8.462, 6.73, 70.584, 13846.853,
27.81, 6.33, 0.0113, 1492.012, 0.3, 98.14, 21 Sep 2015, 13:45:50, 1, 0
(instrument ID and serial number, temperature, conductivity, pressure, oxygen, pH, fluorescence, turbidity, fluorescence
standard deviation, turbidity standard deviation, salinity, sound velocity, specific conductivity, % oxygen saturation, date, time,
sample number, error flag)
```

Note:

- For ease in reading, the data structure is shown with each XML tag on a separate line. However, there are no carriage returns or line feeds between tags (see example below).
- The HydroCAT-EP uses the raw phase delay and raw thermistor voltage from the integrated DO sensor, along with pressure and salinity data from the CTD, to compute and output oxygen in ml/L or mg/L. If the HydroCAT-EP does not include a pressure sensor, it uses the HydroCAT-EP's reference pressure (**ReferencePressure=**) in the pressure correction term of the oxygen equation.
- See *Calculation of Oxygen Saturation* in *Appendix III: RS-232 Command Summary and Details* for oxygen saturation algorithm.

- **OutputFormat=2:** converted decimal data in XML

```

<?xml version="1.0"?>
<datapacket>
<hdr>
<mfg>Sea-Bird</mfg>
<model>HydroCAT-EP</model>
<id>48</id>
<sn>037nnnnn</sn>
</hdr>
<data>
<t1>tttt.tttt</t1>
<c1>c</c1>
<p1>pppppp.ppp </p1>
<ox63r>ooo.ooo </ox63r>
<pH>p.pp</pH>
<fl std='sdf'>fff.fff </fl>
<ntu std='sdt' >ttt.ttt</ntu>
<sal>ssss.ssss</sal>
<sv>vvvvv.vvv </sv>
<sc>x</sc>
<oxSat>ss.ss</oxSat>
<smpl>n</smpl>
<dt>yyyy-mm-ddThh:mm:ss</dt>
<flags>0</flags>
</data>
</datapacket>

```

where

- 037nnnnn = HydroCAT-EP serial number
- tttt.tttt = temperature; sent if output enabled; °C or °F.
- c = conductivity; sent if output enabled.
ccc.cccc if conductivity units set to S/m.
cccc.cccc if conductivity units set to mS/cm.
cccccc.c if conductivity units set to µS/cm.
- pppppp.ppp = pressure; sent if pressure sensor installed and output enabled; dbar or psi.
Number of digits to left of decimal place is dependent on pressure sensor range.
- ooo.ooo = oxygen; sent if oxygen sensor installed and output enabled; ml/L or mg/L.
- p.pp = pH; sent if pH output enabled.
- ffff.fff = fluorescence; sent if HCO installed and output enabled; µg/L.
*Note: Calculated using highest gain channel with raw value (from **OutputFormat=0**) < 14000.*
- sdf = standard deviation of output fluorescence channel, to two decimal places; sent if HCO installed and output enabled.
- tttt.ttt = turbidity; sent if HCO installed and output enabled; NTU.
*Note: Calculated using highest gain channel with raw value (from **OutputFormat=0**) < 14000.*
- sdt = standard deviation of output turbidity channel, to two decimal places; sent if HCO installed and output enabled.
- ssss.ssss = salinity; psu; sent if output enabled.
- vvvvv.vvv = sound velocity; m/sec; sent if output enabled.
- x = specific conductivity; sent if output enabled.
xxx.xxxxx if conductivity units set to S/m.
xxxx.xxxx if conductivity units set to mS/cm.
xxxxxxx.x if conductivity units set to µS/cm.
- ss.ss = percent oxygen saturation; %; sent if output enabled and oxygen sensor installed.

- n = sample number in FLASH memory (sent if output enabled, and autonomous sampling or using polled sampling commands that store data in FLASH memory or retrieve last sample from FLASH memory).
- dd mmm yyyy = day, month, year.
- hh:mm:ss = hour, minute, second.
- flag = error flag;
0 = good, 1 = low battery, 2 = did not take 30 HCO measurements, 4 = HCO wiper position error, 8 = oxygen sensor error, 16 = HCO not sampled, 32 = pump stalled, 64 = pH not sampled; other numbers combination of flags
(for example, 65 = 1 [low battery] and 64 [pH not sampled])

Leading zeros are suppressed, except one zero to the left of the decimal point.

Example: Sample data output for real-time autonomous data transmitted via RS-232 when all optional sensors installed, and outputting all parameters:

```
<?xml version="1.0"?><datapacket><hdr><mfg>Sea-Bird</mfg>
<model>HydroCAT-EP</model><sn>03730078</sn></hdr><data><t1>23.2831</t1><c1>0.3</c1>
<p1>-0.058</p1><ox63r>8.462</ox63r><pH>6.73</pH><fl std='27.81'>70.584</fl>
<ntu std='6.33'>13846.853</ntu><sal>0.0113</sal><sv>1492.012</sv><sc>0.3</sc>
<oxSat>98.14</oxSat><smpl>1</smpl><dt>2015-09-21T13:45:50</dt></data><flags>0</flags>
</datapacket> CRLF
```

(manufacturer, model, serial number, temperature, conductivity, pressure, oxygen, pH, fluorescence average and standard deviation, turbidity average and standard deviation, salinity, sound velocity, specific conductivity, % oxygen saturation, sample number, date and time, error flag)

Note:

- HydroCAT-EP automatically outputs in this format over the SDI-12 line. Setting **OutputFormat=3** allows you to view the SDI-12 data output string while communicating via RS-232.
- The HydroCAT-EP uses the raw phase delay and raw thermistor voltage from the integrated DO sensor, along with pressure and salinity data from the CTD, to compute and output oxygen in ml/L or mg/L. If the HydroCAT-EP does not include a pressure sensor, it uses the HydroCAT-EP's reference pressure (**ReferencePressure=**) in the pressure correction term of the oxygen equation.
- See *Calculation of Oxygen Saturation* in *Appendix III: RS-232 Command Summary and Details* for oxygen saturation algorithm.

- OutputFormat=3:** converted decimal data in SDI-12 format
`a+tttt.tttt+c+pppp.ppp+ooo.ooo+p.pp+ffff.fff+tttt.ttt`
`+sdf+sdt+ssss.ssss+vvvv.vvv+ss.ss+v.v+n+flag`
where
 - a = SDI-12 address
 - (+ or -) sign precedes each parameter
 - tttt.tttt = temperature; sent if output enabled; °C or °F.
 - c = conductivity; sent if output enabled.
cccc.cccc if conductivity units set to S/m.
cccc.cccc if conductivity units set to mS/cm.
ccccccc.c if conductivity units set to µS/cm.
 - pppp.ppp = pressure; sent if pressure sensor installed and output enabled; dbar or psi.
Number of digits to left of decimal place is dependent on pressure sensor range.
 - ooo.ooo = oxygen; sent if oxygen sensor installed and output enabled; ml/L or mg/L.
 - p.pp = pH; sent if pH output enabled.
 - ffff.fff = fluorescence; sent if HCO installed and output enabled; µg/L.
*Note: Calculated using highest gain channel with raw value (from **OutputFormat=0**) < 14000.*
 - ttt.ttt = turbidity; sent if HCO installed and output enabled; NTU.
*Note: Calculated using highest gain channel with raw value (from **OutputFormat=0**) < 14000.*
 - sdf = standard deviation of output fluorescence channel, to two decimal places; sent if HCO installed and output enabled.
 - sdt = standard deviation of output turbidity channel, to two decimal places; sent if HCO installed and output enabled.
 - ssss.ssss = salinity; psu; sent if output enabled.
 - vvvv.vvv = sound velocity; m/sec; sent if output enabled.
 - x = specific conductivity; sent if output enabled.
xxx.xxxxx if conductivity units set to S/m .
xxxx.xxxx if conductivity units set to mS/cm.
xxxxxxx.x if conductivity units set to µS/cm.
 - ss.ss = percent oxygen saturation; %; sent if output enabled and oxygen sensor installed.
 - v.v = main power supply voltage (internal battery pack or external power, as applicable). Not stored in memory.
 - n = sample number in FLASH memory; sent if output enabled.
Value is '-1' if using polled sampling command that does not store data in FLASH memory or if sending **GetSamples:b,e.**
 - flag = error flag;
0 = good, 1 = low battery, 2 = did not take 30 HCO measurements,
4 = HCO wiper position error, 8 = oxygen sensor error,
16 = HCO not sampled, 32 = pump stalled, 64 = pH not sampled; other numbers combination of flags
(for example, 65 = 1 [low battery] and 64 [pH not sampled])

Note the following:

- Polarity sign is always sent.
- Decimal point is optional.
- Maximum digits for a value is 7, even without a decimal point.
- Minimum digits for a value is 1.
- Maximum characters in data value is 9 (sign, 7 digits, decimal point).
- Leading zeros are suppressed, except one zero to left of decimal point.

Example: Sample data output when all optional sensors installed, and outputting all parameters:

```
0+23.2831+0.3-0.058+8.462+6.73+70.584+13846.85+27.81+6.33+0.0113+1492.012+0.3+98.14+
13.8+1+0
```

(SDI-12 address, temperature, conductivity, pressure, oxygen, pH, fluorescence, turbidity, fluorescence standard deviation, turbidity standard deviation, salinity, sound velocity, specific conductivity, % oxygen saturation, power supply voltage, sample number, error flag)

Optimizing Data Quality

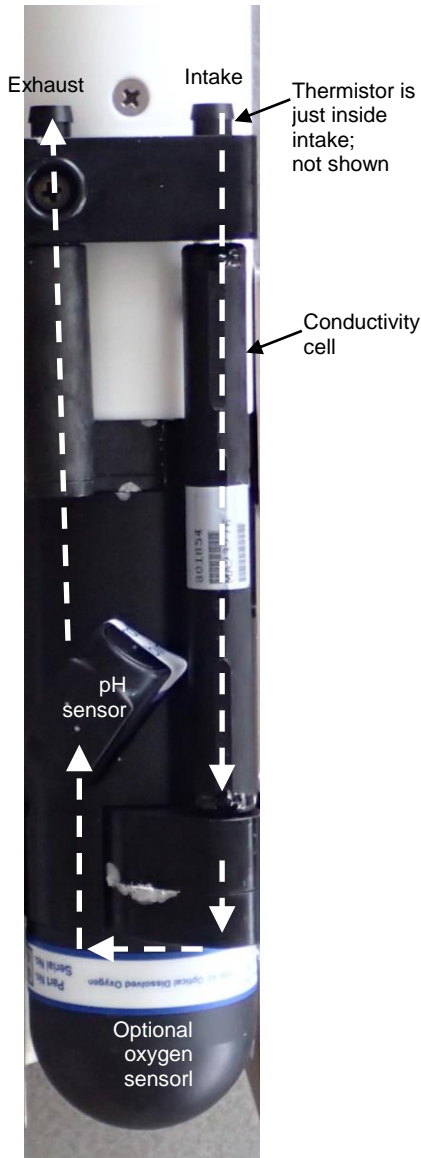

Preferred orientation - Upright U-Shape; connector end at top (shown with conductivity cell guard and anti-foulant fittings removed). Note: Optional HCO (fluorescence and turbidity sensor) is not in the flow path.

Background Information

The HydroCAT-EP orientation affects the pump operation, impacting data quality. Air must exit the plumbing for the pump to prime and operate. Air most easily exits the plumbing if the HydroCAT-EP is deployed with the plumbing in an upright U-shape (connector end up). In considering the effect of air on the pump, it can be instructive to look at the amount of air in the water column:

- **Case 1:** The top ~2 meters of the water column may contain a continuous supply of bubbles injected into the system by breaking waves. In this area, the ability to continuously eliminate air from the system, throughout the deployment, is of prime concern.
- **Case 2:** The next ~30 meters of the water column is not typically affected by bubbles from breaking waves. It could take a few days to weeks after deployment for the air to clear out of the system in an inverted U-shape (connector end down). However, once the air was bled, no more air would be injected into the plumbing.
- **Case 3:** Below ~30 meters, it could take only a few hours to a day for the air to clear out of the system in an inverted U-shape. As in Case 2, once the air was bled, no more air would be injected into the plumbing.

Deployment Recommendations

- **Most deployments** – Deploy the HydroCAT-EP with the plumbing in an **upright U-shape** (as shown in the photos; connector end up). This orientation provides optimal bleeding of air from the plumbing, but leaves the HydroCAT-EP vulnerable to ingestion of sediment.
- **When sediment is an issue** – In areas of moderate to high turbidity (> 200 NTU), the ingestion of sediment is an issue when deployed with the plumbing in an upright U-shape (connector end up). A pump clogged with sediment results in poor flushing, causing poor quality data. For these applications, deploy the HydroCAT-EP with the plumbing in an **inverted U-shape** (connector end down).

If deploying with a cable: With the HydroCAT-EP intake and exhaust in the water, run the pump for 5 - 15 minutes upon deployment (using **Start Pumping** in UCI). This will help to clear any air from the system. Then flip the HydroCAT-EP into the desired inverted U-shape position, while keeping the intake and exhaust in the water.

If deploying without a cable: If you cannot run the pump upon initial deployment, you need to allow time for trapped air to dissolve into the water and the pump to prime properly. This deployment method will provide good data within a day for deployment s deeper than ~30 meters. Eliminate scans associated with the initial deployment by evaluating the conductivity data; minimal changes in conductivity are an indication that pump flow is not correct because air in the plumbing has prevented the pump from priming.

- **When (for mounting reasons) preferred orientation is horizontal** – Sea-Bird does not recommend horizontal mounting, because sediment can accumulate in the conductivity cell, resulting in very poor quality conductivity data. **As a minimum, incline the HydroCAT-EP 10 degrees above the horizontal, with the intake above the exhaust**, to prevent sediment accumulation and provide proper pump operation.

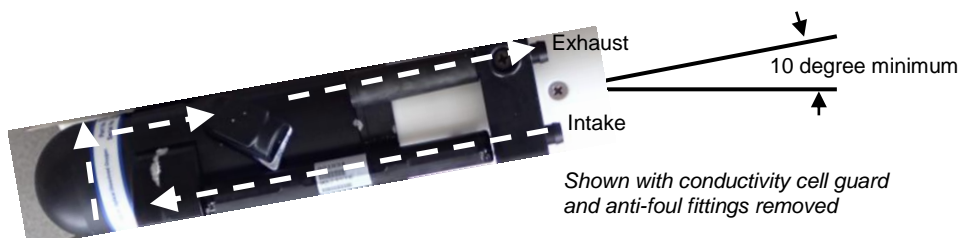

Shown with conductivity cell guard and anti-foul fittings removed

Setup for Deployment

1. Install new AA lithium cells (see *Section 5: Routine Maintenance and Calibration*) or ensure the existing battery pack has enough capacity to cover the intended deployment.
2. If pH sensor was removed for storage, reinstall it (see *Section 5: Routine Maintenance and Calibration*).
3. Via **Transfer Data** in UCI, ensure all data has been uploaded (see *Uploading Data* later in this section).
4. Remove yellow protective label from plumbing intake and exhaust.
5. Remove red vinyl cap from end of HCO (optional fluorescence and turbidity sensor).
6. (if desired) Via **Conductivity Check** in UCI, verify the conductivity output stability and accuracy.
7. (if desired) Via **Temperature Check** in UCI, verify the temperature output stability and accuracy.
8. (if desired) Via **Optics Check** in UCI, verify the optics output (fluorometer and turbidity sensor) stability and accuracy.
9. (if desired) Via **pH Calibration** in UCI, verify the pH sensor stability and accuracy / update the pH calibration coefficients.
10. Via **HydroCAT-EP Settings** in UCI, establish setup parameters.
11. Via **Command Terminal** in UCI, check status (**GetSD**) and calibration coefficients (**GetCC**) to verify setup.
12. Via **Start** in UCI, start autonomous sampling and view data in the Real Time Display and the Time Series plot to verify setup and operation. Click **Stop** when you are done.
13. For SDI-12 deployments: Program the SDI-12 controller to send periodic requests to run the pump and take a sample (aM!, aMC!, aC!, or aCC! store data in HydroCAT-EP FLASH memory; aM1!, aMC1!, aC1!, or aCC1! do not store data in FLASH memory), and then to transmit the sample (aD0!, aD1!, etc.).
14. Via **Deployment Wizard** in UCI:
 - A. Set Operating Mode (Autonomous or Polled Sampling).
 - For Autonomous Sampling, set sample interval and start date and time.
 - For Polled Sampling via SDI-12: set SDI-12 address and bad data flag.
 - B. Set parameters to output and parameter units for real-time data.
 - C. Synchronize time in HydroCAT-EP with computer time, and (if desired) make entire memory available for recording.
 - D. Enter any Deployment notes, and enter/select a file name and location for the Deployment Report.

Note:

The conductivity cell must have all salt water residue removed and be dry for the first part of the Conductivity Check, which checks the *Zero Conductivity Frequency*. Rinse the cell well with fresh water, and then shake out any water. **Do not use compressed air**, which typically contains oil vapor, to dry the cell. See *Conductivity and (optional) Dissolved Oxygen Sensor Maintenance* in *Section 5: Routine Maintenance and Calibration* for details on using the syringe kit to flush and fill the cell for the Conductivity Check.

Notes for Autonomous Sampling:

- You can program an RS-232 controller to send periodic requests to transmit the last data sample from the HydroCAT-EP memory (**SL**) while sampling autonomously.
- You cannot view real-time autonomous data **in UCI** if you start autonomous sampling via **Deployment Wizard**. UCI automatically disconnects from the HydroCAT-EP when you click Finish, and automatically sends a command to stop logging when you reconnect. If desired, you can connect to the HydroCAT-EP with a terminal program to view real-time data.

Deployment



1. New HydroCAT-EPs are shipped with AF24173 Anti-Foulant Devices and a yellow protective label pre-installed.
 - A. Remove the protective label, if installed, from the intake and exhaust. **The label must be removed prior to deployment or pressurization.** If the label is left in place, the flow will be impeded, the sensor will not operate properly, and you may cause severe damage to the conductivity cell.
 - B. Remove the copper anti-foulant assembly and the anti-foulant cap, and verify that the Anti-Foulant Devices are installed (see *Replacing Anti-Foulant Devices – Mechanical Design Change in Section 5: Routine Maintenance and Calibration*). Replace the cap and assembly.
2. Pull gently to remove the red vinyl cap from the HCO (it is held in place by suction and friction).

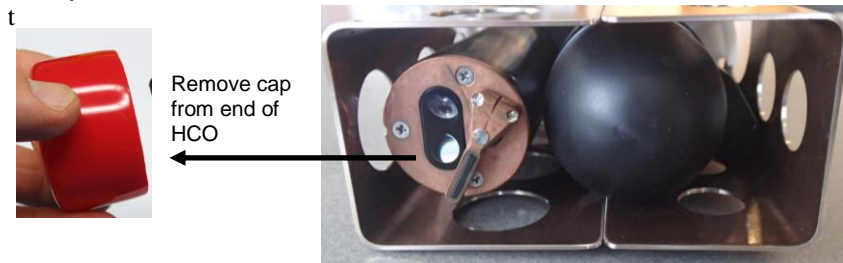

CAUTIONS:

- Do not use WD-40 or other petroleum-based lubricants, as they will damage the connectors.
- For wet-pluggable MCBH connectors: **Silicone lubricants in a spray can** may contain ketones, esters, ethers, alcohols, or glycols in their propellant. **Do not use these sprays, as they will damage the connector.**

3. Install the dummy plug or I/O cable (for external power and/or communication during deployment):
 - A. Lightly lubricate the inside of the dummy plug or cable connector with silicone grease (DC-4 or equivalent).
 - B. Install the plug/cable connector, aligning the pins.
 - C. Place the locking sleeve over the plug/connector. Tighten the locking sleeve finger tight only. **Do not overtighten the locking sleeve and do not use a wrench or pliers.**



Shown with optional sensors and bail mounting kit installed

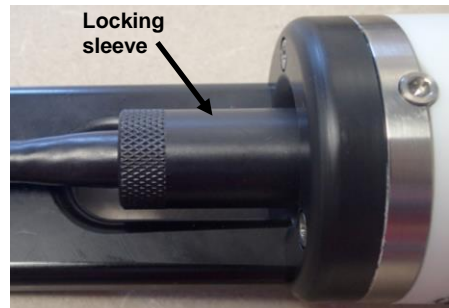
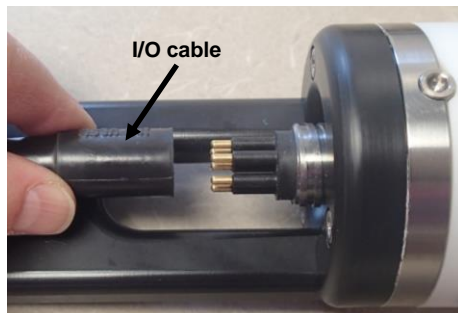

4. Verify that any mounting hardware is secure.
5. Deploy the HydroCAT-EP. Steps A and B below are intended to purge air from the plumbing, so the pump will prime and operate properly.
 - A. Fill the HydroCAT-EP plumbing with water, following the *Filling / Flushing Procedure* in *Section 5: Routine Maintenance and Calibration*. Reinstall the copper guard assembly on the housing, and use the syringe to fill the additional plumbing in that assembly.
 - B. Place the HydroCAT-EP in the water in the vertical position shown and shake it before attaching it to the mooring, to purge any air from the flow path.
 - C. Mount the HydroCAT-EP. See *Optimizing Data Quality* for deployment recommendations.

Recovery

WARNING!

If the HydroCAT-EP stops working while underwater, is unresponsive to commands, or shows other signs of flooding or damage, carefully secure it away from people until you have determined that abnormal internal pressure does not exist or has been relieved. Pressure housings may flood under pressure due to dirty or damaged o-rings, or other failed seals. When a sealed pressure housing floods at great depths and is subsequently raised to the surface, water may be trapped at the pressure at which it entered the housing, presenting a danger if the housing is opened before relieving the internal pressure. Instances of such flooding are rare. However, a housing that floods at 350 meters depth holds an internal pressure of more than 500 psia, and has the potential to eject the end cap with lethal force. A housing that floods at 50 meters holds an internal pressure of more than 85 psia; this force could still cause injury.

If you suspect the HydroCAT-EP is flooded, point it in a safe direction away from people, and loosen the bulkhead connector very slowly, at least 1 turn. This opens an o-ring seal under the connector. Look for signs of internal pressure (hissing or water leak). If internal pressure is detected, let it bleed off slowly past the connector o-ring. Then, you can safely remove the end cap.

- Rinse the instrument, optics end of the HCO, and internal sensors and plumbing with fresh water. (See *Section 5: Routine Maintenance and Calibration* for cleaning and storage.).
 - If the HydroCAT-EP will be out of the water for more than a few minutes but less than a day before you redeploy, fill the plumbing with fresh water (not deionized water) so keep the pH sensor wetted.
 - If you are planning to store the HydroCAT-EP, remove the pH sensor and store it with the glass bulb in KCl solution to prevent the probe from drying out. See *pH Sensor Replacement* in *Section 5: Routine Maintenance and Calibration* for details on removing the pH sensor.
- Install a yellow protective label over the intake and exhaust (1 extra label is included in the spares kit that ships with the HydroCAT-EP).



- Reinstall the protective red vinyl cap over the end of the HCO.



Install cap on end of HCO



- If the battery pack is exhausted, new cells must be installed before the data can be extracted. Stored data will not be lost as a result of exhaustion or removal of the battery pack. See *Section 5: Routine Maintenance and Calibration* for replacement of cells.
 - You can leave the HydroCAT-EP with battery pack in place and in a quiescent state. Because the quiescent current required is small, the battery pack can be left in place without significant loss of capacity, even if planning to store the instrument.

Uploading and Processing Data

1. Connect to the HydroCAT-EP in the UCI.
2. Click **HydroCAT-EP Settings** to review data output and baud rate for upload:
 - A. If desired, modify the output parameters and/or units on the Output Format tab.
 - B. If desired, increase the HydroCAT-EP's baud rate for data upload: select the desired baud rate on the Baud Rate tab.
 Click **Apply**.
3. Click **Transfer Data**. The Transfer Data dialog appears:

Defines data upload type and range:

1. All data– All data is uploaded into 1 file.
2. Scan number range – Enter beginning scan (sample) number and total number of scans. All data within range is uploaded into 1 file.

Select time format for output file – UTC (Universal) time or Local Time.

Type in the desired file name and click Browse to navigate to desired upload file path. Upload file has a .csv extension.

Select number of bytes uploaded in each block. UCI uploads data in blocks, and calculates a checksum at end of each block. If block fails checksum verification, UCI tries to upload block of data again, cutting block size in half.

Make the desired selections and click **Transfer**.

4. The Transfer Progress dialog appears. If desired, click Display Data when Transfer Completed to view the data in the Output-Instrument Console when the upload is done.
5. Ensure all desired data has been uploaded from the HydroCAT-EP by reviewing the data. You can modify the parameters output and /or the units (via **HydroCAT-EP Settings**) and upload again if desired.

Section 5: Routine Maintenance and Calibration

This section reviews cleaning and corrosion precautions, connector mating and maintenance, housing handling instructions, O-ring maintenance, replacement of AA cells, replacement of AF24173 Anti-Foulant Devices, conductivity cell and oxygen sensor maintenance, pressure sensor maintenance, optics (fluorometer and turbidity sensor, and check cap) maintenance, pH sensor maintenance and replacement, pump maintenance, and sensor calibration. The accuracy of the HydroCAT-EP is sustained by the care and calibration of the sensors and by establishing proper handling practices.

Cleaning and Corrosion Precautions

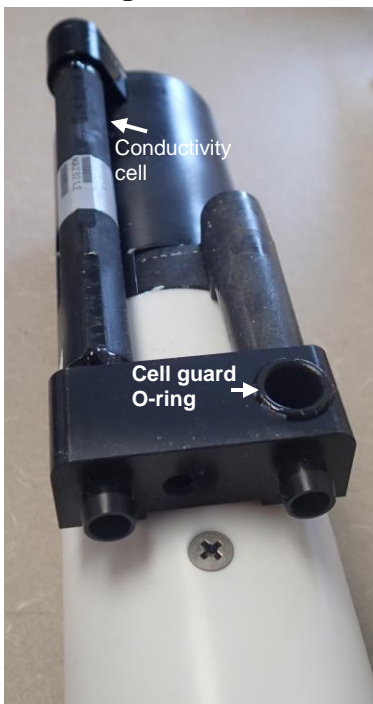

Shown with conductivity cell guard and anti-foul fittings removed

Rinse the HydroCAT-EP with fresh water after use and prior to storage.

If you remove the conductivity cell guard to clean around the conductivity cell and plumbing:

- Handle the instrument carefully to avoid cracking the conductivity cell
- Remove and put in a safe place the cell guard O-ring (PN 30097). Failure to reinstall the O-ring when you replace the cell guard will result in a leak in the flow path, which will affect the data quality.

All exposed metal is titanium; other materials are plastic. No corrosion precautions are required, but direct electrical connection of the HydroCAT-EP housing to mooring or other dissimilar metal hardware should be avoided.

Connector Mating and Maintenance

Note:

See *Application Note 57: Connector Care and Cable Installation*.

Clean and inspect the connectors, cable, and dummy plug before every deployment and as part of your yearly equipment maintenance. Inspect connectors that are unmated for signs of corrosion product around the pins, and for cuts, nicks or other flaws that may compromise the seal.

CAUTIONS:

- **Do not use WD-40** or other petroleum-based lubricants, as they will damage the connectors.
- For wet-pluggable MCBH connectors: **Silicone lubricants in a spray can** may contain ketones, esters, ethers, alcohols, or glycols in their propellant. **Do not use these sprays, as they will damage the connector.**

When remating:

1. Lightly lubricate the inside of the dummy plug/cable connector with silicone grease (DC-4 or equivalent).
2. Install the plug/cable connector, aligning the pins.
3. Place the locking sleeve over the plug/cable connector. Tighten the locking sleeve finger tight only. **Do not overtighten the locking sleeve and do not use a wrench or pliers.**

Verify that a cable or dummy plug is installed on the HydroCAT-EP before deployment.

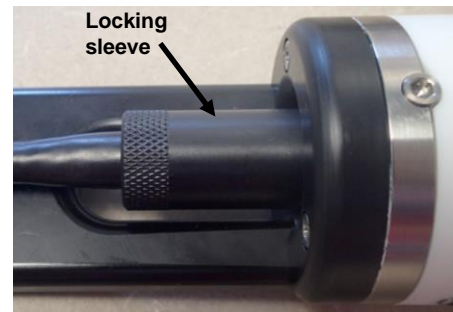
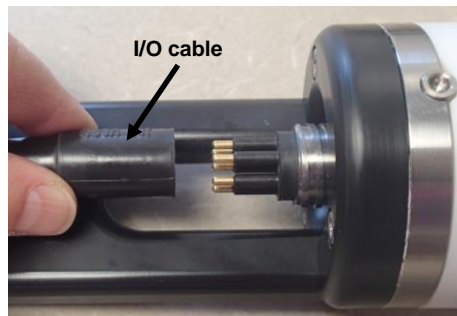

Handling Instructions



Cap screw securing battery / connector end cap (one each side)

CAUTION:

Do not use Parker O-Lube, which is petroleum based; use only Super O-Lube.

To get excellent performance and longevity for the plastic housing:

- The HydroCAT-EP's connector end cap is retained by two screws through the side of the housing. The screw holes are close to the end of the housing. Particularly in a cold environment, where plastic is more brittle, the potential for developing a crack around the screw hole(s) is greater for the plastic housing than for a titanium housing. Observe the following precautions –
 - When removing the end cap (to replace the AA cells and/or to access the electronics), be careful to avoid any impact in this area of the housing.
 - When reinstalling the end cap, do not use excess torque on the screws. Sea-Bird recommends tightening the screws to 15 inch-lbs. Alternatively, tighten the screws finger-tight, and then turn each screw an additional 45 degrees.
- A plastic housing is more susceptible to scratches than a titanium housing. Do not use screwdrivers or other metal tools to pry off the end cap.
 - Of primary concern are scratches on O-ring mating and sealing surfaces. Take extra precaution to avoid a scraping contact with these surfaces when replacing AA cells and/or re-seating the end cap.
 - Also take care to keep the O-ring lubricated surfaces clean – avoid trapping any sand or fine grit that can scratch the critical sealing surfaces. If the O-ring lubricant does accumulate any material or grit that can cause a leak or make a scratch, it must be carefully cleaned and replaced with fresh, clean lubricant (Parker Super O Lube).
 - Shallow, external scratches are cosmetic only, and will not affect the performance of the HydroCAT-EP. However, deep external scratches can become points of weakness for deep deployments or fracture from impact during very cold weather.
- If you remove the screws securing the conductivity cell guard to the housing (for example, to change the Anti-Foulant Devices), follow the same precautions as described above for removing and replacing the connector end cap.

See *Battery Pack Installation* in *Section 3: Preparing HydroCAT-EP for Deployment* and *Appendix II: Electronics Disassembly / Reassembly* for detailed step-by-step procedures for removing the HydroCAT-EP's end caps.

O-Ring Maintenance

Note:

For details on recommended practices for cleaning, handling, lubricating, and installing O-rings, see the *Basic Maintenance of Sea-Bird Equipment* module in the Sea-Bird training materials on our website.

CAUTION:

Do not use Parker O-Lube, which is petroleum based; use only Super O-Lube.

Recommended inspection and replacement schedule:

- For connector end cap O-rings – inspect each time you open the housing to replace the cells; replace approximately once a year.
- For O-rings that are not normally disturbed (for example, on the electronics end cap) - approximately every 3 to 5 years.

Remove any water from the O-rings and mating surfaces in the housing with a lint-free cloth or tissue. Inspect O-rings and mating surfaces for dirt, nicks, and cuts. Clean or replace as necessary. Apply a light coat of O-ring lubricant (Parker Super O Lube) to O-rings and mating surfaces.

Replacing AA Cells

Notes:

- For details and photos, see *Installing Battery Pack* in *Section 3: Preparing HydroCAT-EP for Deployment*.
- Cells must be removed before returning the HydroCAT-EP to Sea-Bird. Do not return used cells to Sea-Bird when shipping the HydroCAT-EP for calibration or repair.

1. Remove the 2 cap screws holding the connector end cap to the HydroCAT-EP housing. Remove the end cap by twisting it counter clockwise; the end cap will release from the housing. Pull the end cap out.
2. Loosen the captured screw holding the battery pack in the housing, and remove the battery pack from the housing.
3. Place the handle in an upright position. Unscrew the yellow cover plate from the top of the battery pack assembly.
4. Roll the 2 O-rings on the outside of the pack out of their grooves.
5. Remove the existing cells. Install new cells, **alternating** positive (+) end first and negative (-) end first to match the labels on the pack.
6. Roll the O-rings into place in the grooves on the side of the battery pack.
7. Place the handle in an upright position. Reinstall the battery pack cover plate.
8. Replace the battery pack assembly in the housing, and secure the assembly with the captured screw. Plug in the Molex connector. Reinstall the HydroCAT-EP end cap, and secure with the 2 cap screws.

Replacing Anti-Foulant Devices – Mechanical Design Change



The AF24173 Anti-Foulant Devices are installed at the intake and the pump exhaust. Details are provided below on replacing the AF24173 Anti-Foulant Devices. This page provides the mechanical details for the HydroCAT-EP. The following page, developed for an older Sea-Bird Electronics instrument, provides the precautions and handling details.

1. Loosen the two captured 5/32" cap screws holding the copper anti-foulant assembly to the housing clamp, using the 5/32-inch Allen wrench (supplied). Carefully remove the copper anti-foulant assembly.



2. Remove the three Phillips-head screws from the copper anti-foulant assembly, and pull the copper guard off. *Note: The 5/32" cap screws are not captured once you remove the copper guard.*

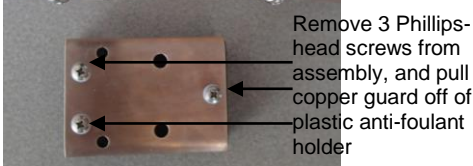

3. Remove the one Phillips-head screw attaching the anti-foulant cap to the anti-foulant holder. Pull the cap off, exposing the AF24173 Anti-Foulant Devices.

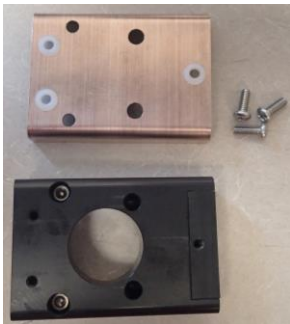

Remove screw, and pull cap off

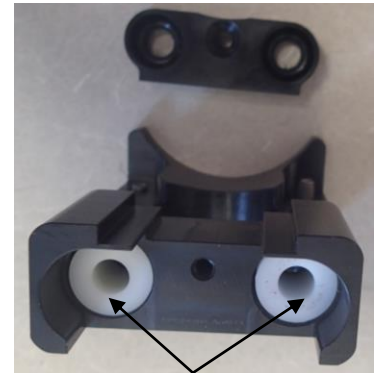

4. Remove and replace the Anti-Foulant Devices.
5. Replace the anti-foulant cap, securing it to the holder with the Phillips-head screw.
6. Place the copper guard on the plastic assembly, and secure with the three Phillips-head screws.
7. Replace the copper anti-foulant assembly on the housing. Secure the assembly to the housing with the two captured cap screws; alternate tightening the screws to secure, maintaining even gaps on the sides.

Push copper anti-foulant assembly while tightening captured cap screws



Replacing Anti-Foulant Devices (SBE 37-SI, SM, IM)



AF24173
Anti-Foulant
Device

The MicroCAT has an anti-foulant device cup and cap on each end of the cell. New MicroCATs are shipped with an Anti-Foulant Device and a protective plug pre-installed in each cup.

WARNING!

AF24173 Anti-Foulant Devices contain bis(tributyltin) oxide. Handle the devices only with rubber or latex gloves. Wear eye protection. Wash with soap and water after handling.

Read precautionary information on product label (see Appendix IV) before proceeding.

It is a violation of US Federal Law to use this product in a manner inconsistent with its labeling.

Wearing rubber or latex gloves, follow this procedure to replace each Anti-Foulant Device (two):

1. Remove the protective plug from the anti-foulant device cup;
2. Unscrew the cap with a $\frac{5}{8}$ -inch socket wrench;
3. Remove the old Anti-Foulant Device. If the old device is difficult to remove:

- Use needle-nose pliers and carefully break up material;
- If necessary, remove the guard to provide easier access.

Place the new Anti-Foulant Device in the cup;

4. Rethread the cap onto the cup. Do not over tighten;
5. If the MicroCAT is to be stored, reinstall the protective plug. **Note that the plugs must be removed prior to deployment or pressurization.** If the plugs are left in place during deployment, the cell will not register conductivity. If left in place during pressurization, the cell may be destroyed.

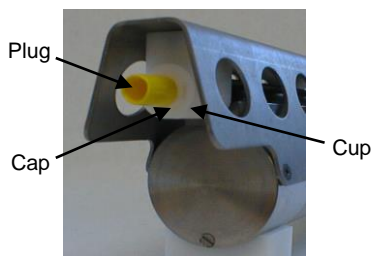
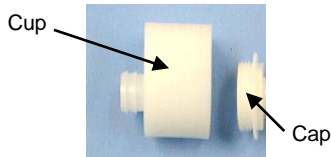

CAUTION:

Anti-foulant device cups are attached to the guard and connected with tubing to the cell. **Removing the guard without disconnecting the cups from the guard will break the cell.** If the guard must be removed:

1. Remove the two screws connecting each anti-foulant device cup to the guard.
2. Remove the four Phillips-head screws connecting the guard to the housing and sensor end cap.
3. Gently lift the guard away.

Conductivity Cell and (optional) Dissolved Oxygen Sensor Maintenance

CAUTIONS:

- **Do not put a brush or any object inside the plumbing to clean it.** Touching and bending conductivity cell electrodes can change the calibration; large bends /movement of the electrodes can damage the cell. Touching or wiping the oxygen sensor window can damage it.
- **Do not store with water in the plumbing.** Freezing temperatures (for example, Arctic environments or during air shipment) can break the conductivity cell or damage the oxygen sensor if it is full of water.
- During service and storage, **maintain temperatures between 0 - 40 °C (32 – 104 °F).**
- **Do not use stronger solutions or longer wash times than recommended.** Prolonged exposure of the dissolved oxygen sensor optical window to Triton X-100 may be harmful.

The HydroCAT-EP's conductivity cell, plumbing, and oxygen sensor plenum are shipped dry to prevent freezing in shipping.

Cleaning Guidelines

Follow these guidelines for cleaning and storage (see below for *Cleaning Materials* and *Filling / Flushing Procedure*):

- **Routine Cleaning (no visible deposits or marine growths on HydroCAT-EP)** -- Follow this two-step procedure:
 1. **Flush** the plumbing for **1 minute** with a **1%** solution of **Triton X-100** warmed to 30 °C (86 °F). **Drain and flush** with warm (not hot) fresh water for **5 minutes**.
 2. **Soak** - Fill the plumbing for **1 minute** with a **500 - 1000 ppm** solution of **Bleach**. After the soak, **drain and flush** with warm (not hot) fresh water for **5 minutes**.
- **Cleaning severely fouled sensors (visible deposits or marine growths on HydroCAT-EP):** Fill the plumbing with de-ionized water overnight to loosen deposits. Repeat the *Routine Cleaning* procedure up to 5 times. Do **not** attempt to clean the optical window with high pressure flow or by wiping or touching the window.
- **Long-Term Storage (after field use): Do not fill the plumbing with water, Triton solution, or Bleach solution. Store dry.**
 - **If there is danger of freezing**, shake all excess water out of the plumbing. Place a yellow protective label over the intake and exhaust to keep dirt and dust out of the plumbing (1 extra label is included in the spares kit that ships with the HydroCAT-EP).

Cleaning Materials

- **Triton X-100** - 100% Triton X-100 is included with the shipment and may be ordered from Sea-Bird; dilute as directed above. Triton X-100 is Octyl Phenol Ethoxylate, a mild, non-ionic surfactant (detergent), and is manufactured by Avantor Performance Materials (<http://avantormaterials.com/commerce/product.aspx?id=2147509608>). Other liquid detergents can probably be used, but scientific grades (with no colors, perfumes, glycerins, lotions, etc.) are required.
- **Bleach** - Bleach is a common household product used to whiten and disinfect laundry. Commercially available bleach is typically 4% - 7% (40,000 – 70,000 ppm) **sodium hypochlorite** (Na-O-Cl) solution that includes stabilizers. Some common commercial product names are Clorox (U.S.) and eau de Javel (French). Use a 500 - 1000 ppm solution of water and sodium hypochlorite. **Dilute** the concentrated household bleach to 50 to 1 (50 parts water to 1 part bleach) to produce the proper concentration to clean the oxygen sensor.
- **Water** – We recommend de-ionized (DI) water because it is reliably pure, but commercially distilled water or fresh clean tap water is also sufficient for all uses above. **On ships, fresh water can occasionally contain traces of oil and should not be used for rinsing, cleaning, or storing sensors, unless there is no alternative.**



Conductivity Check

Check the performance of the conductivity sensor via the **Conductivity Check** button in UCI. The conductivity check consists of two parts:

- Check of Zero Conductivity Frequency (frequency output of a clean, dry cell) - The conductivity cell must have all salt water residue removed and be dry for this part of the Conductivity Check, which checks the *Zero Conductivity Frequency*. Rinse the cell well with fresh water, and then shake out any water. **Do not use compressed air**, which typically contains oil vapor, to dry the cell. See *Filling / Flushing Procedure* below for details on using the syringe kit to flush the cell for the Conductivity Check.
- Check against a Conductivity Standard solution - Follow the *Filling / Flushing Procedure* below to flush and fill the conductivity cell. When performing the check against a Conductivity Standard solution, push the syringe in and out until you do not see any bubbles; bubbles in the solution will affect the sensor output.

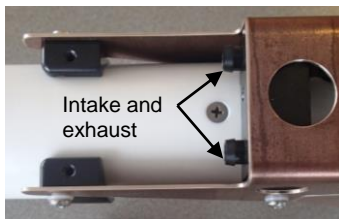

Filling / Flushing Procedure

To rinse or fill the plumbing:

1. Loosen the two captured 5/32" cap screws holding the copper anti-foulant assembly to the housing clamp, using the 5/32-inch Allen wrench (supplied). Carefully remove the copper anti-foulant assembly.
2. Place the HydroCAT-EP in a bucket, with the connector end up so that the plumbing is in a U-shape.
3. Attach a piece of tubing (at least 10 cm long) to the intake or exhaust.
4. Pour approximately 30 ml of the desired solution (see *Cleaning Guidelines* above) into the syringe from the PN 50640 syringe kit (supplied).
5. To flush or fill - Attach tubing from the syringe to the other plumbing port. Push the syringe to fill the plumbing with the fluid; verify that you have at least 3 to 5 cm of fluid head on both the intake and exhaust. Push the syringe in and out to flush the plumbing and sensors for the desired amount of time.

Notes:

- Photos show tubing connecting to the intake and the syringe connected to the exhaust. This can be reversed (i.e., tubing connected to exhaust and syringe connected to intake) with no effect on the results.
- Photos show titanium guards; production models have copper guards.



Use 33" piece when flushing with Triton-X, with end in bottle of Triton-X solution. Otherwise, 9" piece is sufficient.

6. To Drain - Turn HydroCAT-EP over and empty fluid into a bucket, pushing on syringe to help remove all fluid. Remove the tubing and shake the instrument to remove all fluid.
7. Carefully replace the copper anti-foulant assembly on the housing. Secure the assembly to the housing with the two captured cap screws; alternate tightening the screws to secure, maintaining even gaps on the sides.



Push copper anti-foulant assembly while tightening captured cap screws

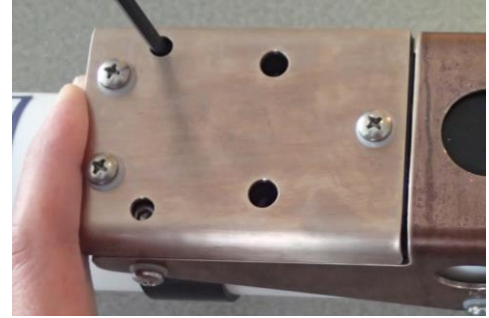

Temperature Check

From repeated calibrations over several years, Sea-Bird temperature sensors typically show very little drift ($< 0.002\text{ }^{\circ}\text{C}$). To identify any significant problems that might be caused by a damaged sensor or instrument malfunction, validate the HydroCAT-EP performance against a reference sensor. **Do not** correct HydroCAT-EP data with a reference sensor that has lower accuracy specifications.

Place the HydroCAT-EP and reference sensor as close together as possible in a stable test bath (stable environment such as a lab; out of direct sunlight and wind). Allow the instruments to stabilize for at least 1 hour in the bath before testing; more time may be required if there is a large difference between room and water temperature. The temperature of the reference sensor in the bath should be stable to within $0.1\text{ }^{\circ}\text{C}$ from the start to the end of the test. The HydroCAT-EP will pass the **Temperature Check** test in the UCI if it reads within $0.2\text{ }^{\circ}\text{C}$ of the reference and shows a stability of 3 readings within $0.01\text{ }^{\circ}\text{C}$. Gradients in a bath and drafts in rooms are common, so small differences between sensors are typically attributed to small differences in the water temperature inside the test bath.

Pressure Sensor (optional) Maintenance

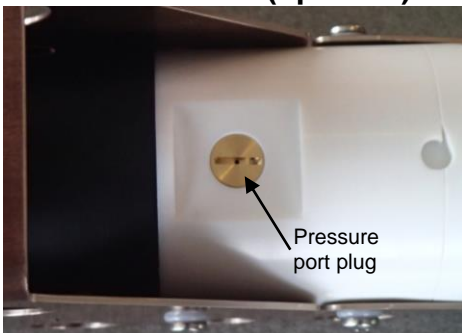

The copper pressure port plug has a small vent hole to allow hydrostatic pressure to be transmitted to the pressure sensor inside the instrument, while providing protection for the pressure sensor, keeping most particles and debris out of the pressure port.

Periodically (approximately once a year) inspect the pressure port to remove any particles, debris, etc.:

1. Unscrew the pressure port plug from the pressure port.
2. Rinse the pressure port with warm, de-ionized water to remove any particles, debris, etc.
3. Replace the pressure port plug.

CAUTION:

Do not put a brush or any object in the pressure port. Doing so may damage or break the pressure sensor.

Optics (optional) Maintenance – HCO and HCC (check cap)

This section describes maintenance of the HCO optics face, HCO wiper blade, and HCC check cap.

HCO Optics

1. Rinse the optics end of the HCO with fresh water. If it is especially dirty, wash it gently with mild dish detergent and warm water. The outside of the instrument within 5 mm of the copper face must be free of contamination.
2. Wipe the HCO optics with a lint-free optics cloth and isopropyl alcohol.

Note:

Photos show a white HCO not installed on HydroCAT-EP. Maintenance procedures are identical to that for the black HCO installed on the HydroCAT-EP.

HCO Wiper

The HCO wipes its optics once before each sample: The instrument wakes up, the wiper rotates across the face, the wiper stops, the lights flash, and then the lights turn off. If the wiper is not in either of the home positions shown below when the instrument wakes up, HCO will first rotate the wiper to one of the home positions. **Do not move the wiper arm by hand.**

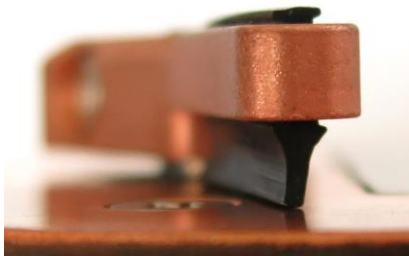

Inspect the wiper blade after each deployment. Replace the wiper blade when it appears excessively worn and it is no longer effectively clearing the optics.

To replace the wiper blade:

1. Loosen the screw on the side of the wiper arm, using a 3/32" hex wrench.
2. Pull the wiper arm straight off the stainless steel shaft.



3. To remove the old blade, grab it firmly and pull it out.



4. To install a new blade, moisten it with water or isopropyl alcohol. Quickly press the large end of the T-shaped blade through the slot in the wiper arm, starting at an angle. Installation requires a pressing and sliding motion. The end of the blade may require some additional gentle encouragement to snap into place.

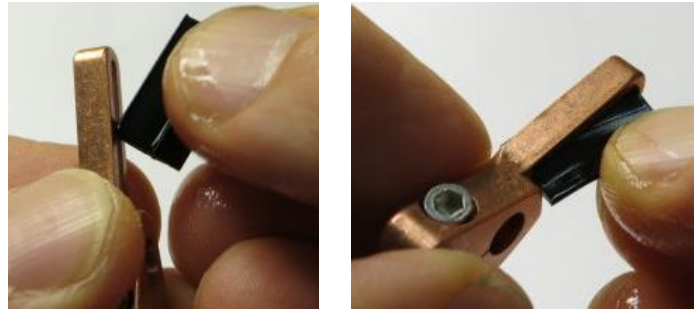
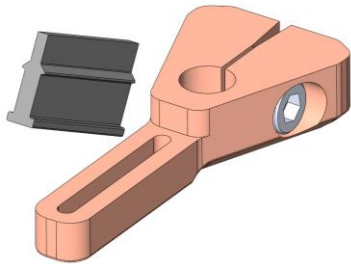

5. Slide the wiper arm onto the stainless shaft until the flat edge of the blade just touches the copper faceplate. Tighten the screw with a 3/32" hex wrench. The blade should be vertical; a slight bend is OK. The blade will last longer if it is not bent when it is over the copper.

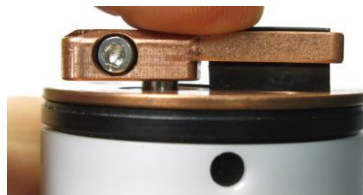

HCC (check cap)

Inspect the HCC before performing the *Fluorometer and Turbidity Calibration* described later in this section.

1. Inspect the orange glass inside the HCC for dust, water spots, or other contamination. It must be clean, dry, and shiny.



Clean, shiny HCC



Dirty HCC

2. Use Dust-Off, other canned air, or dry nitrogen to blow contaminants off of the glass and out of the cavity. If there is nothing wet or sticky on the glass, this will be all you need to do. The optical target will appear clean and it will be ready to use.

3. If the glass is still dirty, a wet cleaning is required:
 - A. Saturate a cotton swab with isopropyl alcohol.
 - B. Gently wipe the filter to dissolve or loosen the contamination.
 - C. While it is still wet with alcohol, rinse the filter **immediately** with DI water to prevent a haze from forming (if a haze has formed, repeat Steps A through C).
 - D. Dab the filter dry with a lint-free wipe (KimWipe or equivalent).
 - E. Blow the filter completely dry with Dust-Off or dry nitrogen.



4. Replace the protective cap on the HCC if not using it immediately for a calibration check.



pH Sensor Maintenance and Replacement

Note:

The pH sensor ships uninstalled, with a cap to keep the sensor wetted. A dummy plug covers the sensor connector in the HydroCAT-EP.

Remove the dummy plug and follow procedures in this section to install the sensor before deployment.

Follow these guidelines for storing the pH sensor:

- If the HydroCAT-EP will be out of the water for more than a few minutes but less than a day before you redeploy, fill the plumbing with fresh water (**not** deionized water) so keep the pH sensor wetted. This prevents the glass bulb and reference electrode from drying out, which could affect the response time and lifetime of the sensor.
- If you are planning to store the HydroCAT-EP, remove the pH sensor and store it with the glass bulb in KCl solution to prevent the probe from drying out. Place the dummy plug (supplied) over the pH connector on the HydroCAT to protect the connector and flow path. See procedure below for details.

Materials needed:

- 5/32-inch Allen wrench (supplied)
- 3/32-inch Allen wrench (supplied)
- isopropyl alcohol
- canned air
- KCl solution
- Parker Super O Lube

Uninstalling pH Sensor from HydroCAT-EP

Procedure:

1. Remove any water from the plumbing before removing the pH sensor, to avoid getting water in the pH sensor connector:
 - A. Loosen the two captured 5/32" cap screws holding the copper anti-foulant assembly to the housing clamp, using the 5/32-inch Allen wrench (supplied). Carefully remove the copper anti-foulant assembly.
 - B. Hold the HydroCAT-EP in a vertical orientation, with the intake and exhaust openings facing down. Shake the HydroCAT-EP to drain and remove any water from the plumbing. Rotate 180° so the openings are facing up, then rotate back so the openings are facing down. Repeat until no water comes out of the plumbing.

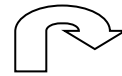
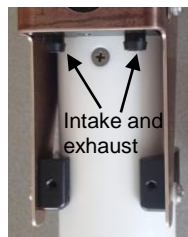
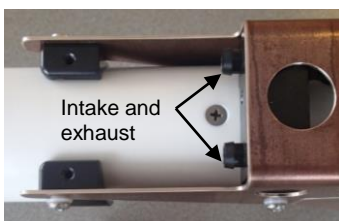

Shake to remove water. Rotate 180° (intake and exhaust openings facing up), then rotate 180° (intake and exhaust openings facing down) and repeat.



Note: Photo shows titanium guard; production models have copper guard.

2. Thoroughly clean and dry the area around the pH sensor to avoid getting water or dirt on the pH sensor and / or connector.

Copper tube on opposite side of HydroCAT-EP housing

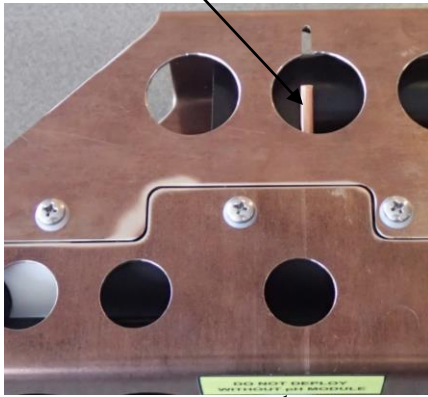

pH sensor (not shown)

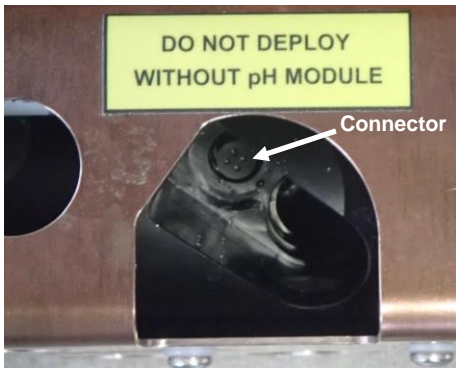

3. Insert a 3/32-inch Allen wrench (supplied) in the copper tube to loosen the cap screw securing the pH sensor. Unthread the screw until you can pull out the pH sensor on the other side.



Note: Photo shows titanium guard; production models have copper guard.

4. Completely clean and dry the connector inside the housing. Make sure to remove any salt crystals or debris from the surfaces. Swab the area with isopropyl alcohol, and then use canned air to completely dry the connector before replacing the sensor.

Rebuilding pH Reference Junction

Sea-Bird recommends that you rebuild and refill the reference junction every 3 to 4 months, or sooner if pH data is unstable or slow, drift is seen in pH data, and/or the pH sensor will not pass the calibration check. The diagram below describes the procedure; the pH sensor on your HydroCAT-EP looks a little different than the diagram, but the procedure details are identical. The materials needed for the procedure are included in a pH reference junction kit, Hach PN 013410HY, that is included with your HydroCAT-EP shipment.

1. Remove the plastic soaking cap. Save the cap for reuse.
2. Use the supplied screwdriver to loosen the Teflon® Reference Junction.
3. Remove the Teflon Reference Junction and discard if dirty or clogged.
4. Replace the blue O-ring located below the Teflon Reference Junction if it is damaged or loose.
5. Drop two KCl salt pellets (Cat. No. 00537HY) into the reference opening.
6. Inject the pH reference electrolyte into the supplied plastic syringe.
7. Refill the reference opening with electrolyte.
8. Use the supplied screwdriver to install the new Teflon Reference Junction (Cat. No. 002770HY).

Installing pH Sensor on HydroCAT-EP

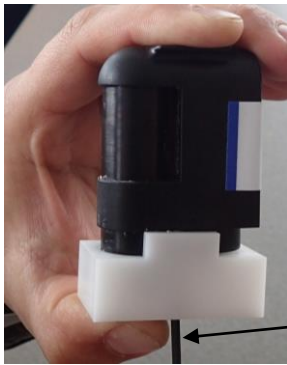

3/32" Allen wrench

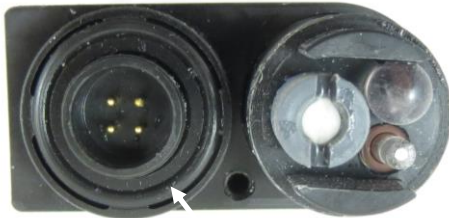

Lube face seal on connector

Push copper anti-foulant assembly while tightening captured cap screws

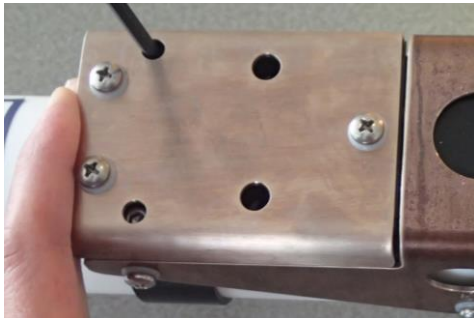

1. Prepare the pH sensor:
 - A. If replacing with a pH sensor supplied by Sea-Bird: The sensor is shipped with a white cap filled with KCl solution, to prevent the glass bulb and reference electrode from drying. Loosen the 3/32" cap screw holding the cap to the pH sensor, keeping the cap at the bottom to avoid spilling the solution. Remove the cap.
 - B. If replacing with a pH sensor you have previously used: Apply a light coat of O-ring lubricant (Parker Super O Lube) to the face seal on the connector; see *O-ring Maintenance* above.
Note: Sensor must be stored with probe in KCl solution to prevent it from drying out.
2. Insert the replacement sensor or (for storage) the dummy plug, and fasten with the 3/32" cap screw.
3. Replace the copper anti-foulant assembly on the housing. Secure the assembly to the housing with the two captured cap screws; alternate tightening the screws to secure, maintaining even gaps on the sides.

Updating pH Calibration Coefficients in HydroCAT-EP

1. Use the UCI software to connect the HydroCAT-EP to the computer (see *Power and Communications Test* in *Section 3: Preparing HydroCAT-EP for Deployment*).
2. Click **Command Terminal**.
 - A. In the Terminal Window, type **ReSync** and click **Submit**; this retrieves the calibration coefficients from the integrated sensors (pH, oxygen, and HCO), and programs them into the HydroCAT-EP for use in any calculations. **This is required to get the new pH sensor serial number and calibration coefficients uploaded to the HydroCAT-EP.**
 - B. Close the Terminal Window.

Pump Maintenance

Sediment in the pump can affect pump operation, impacting data quality. If you suspect the HydroCAT has ingested sediment, put the HydroCAT-EP in clean water and run the pump for 15 minutes (click **Start Pumping** in UCI).

Sensor Calibration

Notes:

- AA cells must be removed before returning the HydroCAT-EP to Sea-Bird. Do not return used cells to Sea-Bird when shipping the HydroCAT-EP for recalibration or repair.
- Please remove AF24173 Anti-Foulant Devices from the anti-foulant device cup before returning the HydroCAT-EP to Sea-Bird. Store them for future use. See *Replacing Anti-Foulant Devices* for removal procedure.

Sea-Bird sensors are calibrated by subjecting them to known physical conditions and measuring the sensor responses. Coefficients are then computed, which may be used with appropriate algorithms to obtain engineering units. The sensors on the HydroCAT-EP are supplied fully calibrated, with coefficients printed on their respective Calibration Certificates (see back of manual). These coefficients have been stored in the HydroCAT-EP's EEPROM.

We recommend that HydroCAT-EP s be returned to Sea-Bird for calibration every twelve months.

Conductivity Sensor Calibration

The conductivity sensor incorporates a fixed precision resistor in parallel with the cell. When the cell is dry and in air, the sensor's electrical circuitry outputs a frequency representative of the fixed resistor. This frequency is recorded on the Calibration Certificate and should remain stable (within 1 Hz) over time.

The primary mechanism for calibration drift in conductivity sensors is the fouling of the cell by chemical or biological deposits. Fouling changes the cell geometry, resulting in a shift in slope. Accordingly, the most important determinant of long-term sensor accuracy is the cleanliness of the cell. We recommend that the conductivity sensor be calibrated before and after deployment, but particularly when the cell has been exposed to contamination by oil slicks or biological material.

Temperature Sensor Calibration

The primary source of temperature sensor calibration drift is the aging of the thermistor element. Sensor drift will usually be a few thousandths of a degree during the first year, and less in subsequent intervals. Sensor drift is not substantially dependent upon the environmental conditions of use, and — unlike platinum or copper elements — the thermistor is insensitive to shock.

Dissolved Oxygen Sensor (optional) Calibration

The primary mechanism for calibration drift in optical oxygen sensors is the fouling of the optical window by chemical or biological deposits. Accordingly, the most important determinant of long-term sensor accuracy is the cleanliness of the window. We recommend that the oxygen sensor be calibrated before and after deployment, but particularly when the sensor has been exposed to contamination by oil slicks or biological material.

Another important mechanism for oxygen sensor drift is photobleaching of the sensor film. Keep the SBE 63 sensor film out of direct sunlight if detached from the main body of the HydroCAT-EP. Also, every sample that is taken illuminates the film with short wavelength light that eventually degrades the film. As a rule of thumb, re-calibration of the oxygen sensor on the HydroCAT-EP is recommended when enough samples are taken to fill the HydroCAT-EP's memory.



Shown with conductivity cell guard and anti-foul fittings removed

Pressure Sensor (optional) Calibration

The optional strain-gauge pressure sensor is a mechanical diaphragm type, with an initial static error band of 0.05%. Consequently, the sensor is capable of meeting the HydroCAT-EP's 0.10% error specification with some allowance for aging and ambient-temperature induced drift.

Pressure sensors show most of their error as a linear offset from zero.

A technique is provided below for making small corrections to the pressure sensor calibration using the *offset* (**POffset=**) calibration coefficient term by comparing HydroCAT-EP pressure output to readings from a barometer.

Allow the HydroCAT-EP to equilibrate in a reasonably constant temperature environment for at least 5 hours before starting. Pressure sensors exhibit a transient change in their output in response to changes in their environmental temperature. Sea-Bird instruments are constructed to minimize this by thermally decoupling the sensor from the body of the instrument. However, there is still some residual effect; allowing the HydroCAT-EP to equilibrate before starting will provide the most accurate calibration correction.

Note:

The HydroCAT-EP's pressure sensor is an absolute sensor, so its **raw** output (**OutputFormat=0**) includes the effect of atmospheric pressure (14.7 psi). As shown on the Calibration Sheet, Sea-Bird's calibration (and resulting calibration coefficients) is in terms of psia. However, when outputting pressure in **psi** or **decibars**, the HydroCAT-EP outputs pressure relative to the ocean surface (i.e., at the surface the output pressure is 0 psi or 0 dbar).

The HydroCAT-EP uses the following equations to convert psia:

$$P (\text{psi}) = P (\text{psia}) - 14.7$$

$$P (\text{dbar}) = [P (\text{psia}) - 14.7] * 0.689476$$

1. Place the HydroCAT-EP in the orientation it will have when deployed.
2. While connected in UCI:
 - A. Click **HydroCAT-EP Settings**. Enable pressure output, and set pressure output units to decibars. Click **Apply**.
 - B. In the Sensor menu, select HydroCAT-EP / Advanced / Pressure Offset. In the Pressure Offset dialog box, set the pressure offset to 0.0 and click **OK**.
 - C. Click **Command Terminal**.
 - D. Send **TSN:100** to take 100 samples (without running the pump) and transmit data.
 - E. Highlight the data and copy it (Ctrl C); strip out the command lines and paste the data into a spreadsheet to calculate the average.
 - F. Close the Command Terminal.
3. Compare the HydroCAT-EP output to the reading from a good barometer at the same elevation as the HydroCAT-EP's pressure sensor port. Calculate *offset* = barometer reading – HydroCAT-EP reading
4. In the Sensor menu, select HydroCAT-EP / Advanced / Pressure Offset. In the Pressure Offset dialog box, set the pressure offset to the calculated value (positive or negative) and click **OK**.

Offset Correction Example

Absolute pressure measured by a barometer is 1010.50 mbar. Pressure displayed from HydroCAT-EP is -2.5 dbar.

Convert barometer reading to dbar using the relationship: mbar * 0.01 = dbar

Barometer reading = 1010.50 mbar * 0.01 = 10.1050 dbar

The HydroCAT-EP's internal calculations output gauge pressure, using an assumed value of 14.7 psi for atmospheric pressure. Convert HydroCAT-EP reading from gauge to absolute by adding 14.7 psia to the HydroCAT-EP's output:

$$-2.5 \text{ dbar} + (14.7 \text{ psi} * 0.689476 \text{ dbar/psia}) = -2.5 + 10.13 = 7.635 \text{ dbar}$$

$$\text{Offset} = 10.1050 - 7.635 = +2.47 \text{ dbar}$$

Enter offset of +2.47 in HydroCAT-EP.

For demanding applications, or where the sensor's air ambient pressure response has changed significantly, calibration using a dead-weight generator is recommended. The pressure sensor port uses a 7/16-20 straight thread for mechanical connection to the pressure source. Use a fitting that has an O-ring tapered seal, such as Swagelok-200-1-4ST, which conforms to MS16142 boss.

pH Sensor Calibration

Update the pH sensor calibration via the **pH Calibration** button in UCI. pH calibration requires the following materials:

- pH buffers with pH 4, 7, and 10. Sea-Bird recommends use of **colorless** buffers; colored buffers can stain the reference electrode junction but do not impact performance. Hach (www.hach.com) is one source of colorless buffers. Verify that the buffers you are using have not expired.
- Deionized water
- Waste bucket

The pH calibration procedure requires a temperature-stable environment, and requires that the HydroCAT-EP, buffer solutions, and deionized water are all at a stabilized temperature. It also requires that the probe not be dried out; if necessary, fill the soaker cap with pH 4 buffer and soak for 24 hours before proceeding. Summarizing the procedure (see details below):

1. Rinse the HydroCAT-EP plumbing with deionized water.
2. Rinse the HydroCAT-EP plumbing with the desired buffer solution to remove all traces of deionized water.
3. Fill the HydroCAT-EP plumbing with the desired buffer solution, and take measurements.
4. Repeat (deionized water, buffer solution, buffer solution and measurements) for each buffer solution.

Proceed as follows:

1. Loosen the two captured 5/32" cap screws holding the copper anti-foulant assembly to the housing clamp, using the 5/32-inch Allen wrench (supplied). Carefully remove the copper anti-foulant assembly.
2. Place the HydroCAT-EP in a bucket, with the connector end up so that the plumbing is in a U-shape.
3. Attach a piece of tubing (at least 10 cm long) to the intake or exhaust.
4. Pour approximately 30 ml of deionized water into the syringe from the PN 50640 syringe kit (supplied).
5. Attach tubing from the syringe to the other plumbing port. Push the syringe to fill the plumbing with the fluid; verify that you have at least 3 to 5 cm of fluid head on both the intake and exhaust. Push the syringe in and out until you do not see any bubbles.

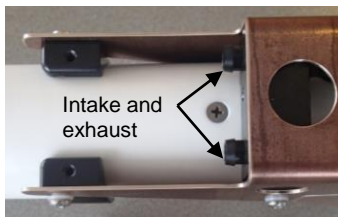

Notes:

- Photos show tubing connecting to the intake and the syringe connected to the exhaust. This can be reversed (i.e., tubing connected to exhaust and syringe connected to intake) with no effect on the results.
- Photos show titanium guards; production models have copper guards.



6. Turn the HydroCAT-EP over and empty fluid into a bucket, pushing on the syringe to help remove all fluid. Remove the tubing and shake the instrument to remove all fluid.

**Note:**

If the sensor fails any step, UCI will show *Calibration step failed* and will not allow you to continue with the other buffer solutions.

7. Connect the HydroCAT-EP to UCI. Click pH Calibration.
8. **Using pH 4 buffer solution**, repeat **Steps 2 through 6**. This thoroughly removes all traces of deionized water.
9. **Using pH 4 buffer solution**, repeat **Steps 2 through 5**. Click Next to move to the pH 4 calibration step. Click Start to start the calibration step. The calibration wizard will run until it determines that the pH reading has stabilized.
10. **Using deionized water**, repeat **Steps 2 through 6** to rinse out the buffer solution.
11. **Using pH 7 buffer solution**, repeat **Steps 2 through 6**. This thoroughly removes all traces of deionized water.
12. **Using pH 7 buffer solution**, repeat **Steps 2 through 5**. Click Next to move to the pH 7 calibration step. Click Start to start the calibration step. The calibration wizard will run until it determines that the pH reading has stabilized.
13. **Using deionized water**, repeat **Steps 2 through 6** to rinse out the buffer solution.
14. **Using pH 10 buffer solution**, repeat **Steps 2 through 6**. This thoroughly removes all traces of deionized water.
15. **Using pH 10 buffer solution**, repeat **Steps 2 through 5**. Click Next to move to the pH 10 calibration step. Click Start to start the calibration step. The calibration wizard will run until it determines that the pH reading has stabilized.
16. **Using deionized water**, repeat **Steps 2 through 6** to rinse out the buffer solution.
17. Follow UCI directions to view information on Calibration Quality and to create the pH Calibration Report.
18. Carefully replace the copper guard assembly on the housing. Secure the assembly to the housing with the two captured cap screws; alternate tightening the screws to secure, maintaining even gaps on the sides.

Push copper anti-foulant assembly while tightening captured cap screws



If the calibration fails, recalibrate after doing one or more of the following:

1. Verify that the pH sensor has been properly maintained, buffers are fresh, and HydroCAT-EP, buffers, and rinse water are at the same temperature.
2. Remove the pH sensor and inspect for fouling on the glass bulb, reference junction, and solution ground. The glass bulb should be clear and shiny. The reference junction should be free of fouling.
3. If the pH sensor is coated with oil, sediment, or biological growth, clean the glass with a clean, soft, wet, non-scratching cloth or cotton ball with mild soap; rinse thoroughly.
4. Fill the soaker cap with pH 4 buffer and soak the pH sensor for 24 hours.
5. Rebuild the reference junction, as described in *pH Sensor Maintenance and Replacement* above.

HCO (optional Fluorometer and Turbidity) Calibration Check

The HCO (fluorometer and turbidity sensor) calibration may be checked using the HCC (check cap), which is an optional accessory. If an HCC was purchased with your HydroCAT-EP, HCC verification values are stored in your HydroCAT-EP. If you already have an HCC, or purchase one separately from the purchase of the HydroCAT-EP, you can program your HCO with verification values to match that HCC using the **SetOpticsRef=** command; see *Appendix III: Rs-232 Command Summary and Details*.

Note:

See *Appendix V: Sources of Variability in HCO Calibration Check* for a detailed discussion of variation due to temperature.

For the calibration check to be valid, the HydroCAT-EP and HCC must be between 18 and 26 °C. Allow at least 1 hour for the HydroCAT-EP and HCC to equilibrate before proceeding:

1. Rinse the optics end of the HCO with fresh water. If it is especially dirty, wash it gently with mild dish detergent and warm water. The outside of the instrument within 5 mm of the copper face must be free of contamination.
2. Wipe the HCO optics with a lint-free optics cloth and isopropyl alcohol.
3. Remove the protective cap from the HCC. Inspect the orange filter inside the HCC. It must be clean and dry. See *Optics Maintenance – HCO and HCC* above.



4. Install the check cap by aligning the pin inside the check cap and the notch on the instrument face. Engage the pin, and then push the cap onto the HCO. When properly installed, the sides of the cap are parallel with the sides of the HCO.

Note: If the current bio-wiper position prevents installation of the check cap, rotate the bio-wiper so you can install the check cap.

Alignment notch (left) and pin (right)

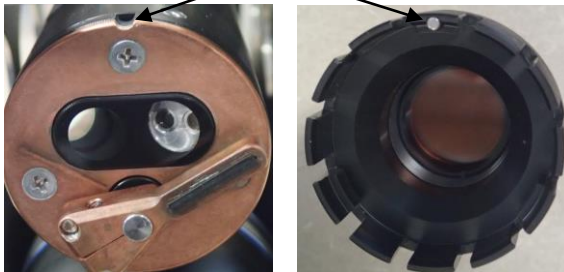

5. Check the HCO calibration via the **Optics Check** button in UCI.
 - If the calibration check fails, see *HCO Calibration Check Failure* in *Section 6: Troubleshooting*.
6. When the calibration check is complete, remove the HCC from the HCO. Place the protective cap on the HCC for storage.

Section 6: Troubleshooting

This section reviews common problems in operating the HydroCAT-EP, and provides the most common causes and solutions.

Problem 1: Unable to Communicate with HydroCAT-EP

Cause/Solution 1: The instrument communication settings may not have been entered correctly in UCI's Connect dialog. Verify the correct COM port has been selected, and that it is set to Try All Baud Rates.

Cause/Solution 2: The I/O cable connection may be loose. Check the cabling between the HydroCAT-EP and computer for a loose connection.

Cause/Solution 3: There may be no battery pack in the HydroCAT-EP. Open the connector end cap and verify that the battery pack is installed, and contains cells.

Cause/Solution 4: The I/O cable between the HydroCAT-EP and computer may not be the correct one. The I/O cable supplied with the HydroCAT-EP permits connection to standard 9-pin RS-232 interfaces.

Problem 2: No Data Recorded

Cause/Solution 1: The memory may be full; once the memory is full, no further data will be recorded. Verify that the memory is not full using **GetSD** (`<SamplesFree>0</SamplesFree>` if memory is full). Sea-Bird recommends that you upload all previous data before beginning another deployment. Once the data is uploaded, click **Deployment Wizard** and select Clear HydroCAT data in Step 3 to reset the memory. After the memory is reset, **GetSD** will show `<Samples>0</Samples>`.

Problem 3: Unreasonable Data

The symptom of this problem is a data file that contains unreasonable values (for example, values that are outside the expected range of the data).

Cause/Solution 1: A data file with unreasonable (i.e., out of the expected range) values may be caused by incorrect calibration coefficients in the HydroCAT-EP. In the Command Terminal, send **GetCC** to verify the calibration coefficients in the HydroCAT-EP match the instrument Calibration Certificates. Note that calibration coefficients do not affect the raw data stored in HydroCAT-EP memory.

- If you have not yet overwritten the memory with new data, you can correct the coefficients and then upload the data again.
- To ensure you are using the latest pH, oxygen, and HCO (fluorometer and turbidity sensor) coefficients, send the **ReSync** command; this retrieves the coefficients from those integrated sensors and programs them into the HydroCAT-EP for use in any calculations.

Cause/Solution 2: Minimal changes in **conductivity** are an indication that the pump flow is not correct. Poor flushing can have several causes:

- Air in the plumbing may be preventing the pump from priming. This can result from:
 - Air in the system. We recommend running the pump for 5 minutes upon initial deployment to remove any air; see *Optimizing Data Quality* in *Section 4: Deploying and Operating HydroCAT-EP*.
 - Incorrect orientation for a shallow deployment in a location with breaking waves; see *Optimizing Data Quality* in *Section 4: Deploying and Operating HydroCAT-EP*.
- The pump may be clogged by sediment. Using a wash bottle, flush the plumbing to attempt to dislodge the sediment. If the sediment is impacted and you cannot flush it, return the HydroCAT-EP to Sea-Bird for servicing. To minimize ingestion of sediment for future deployments, see *Optimizing Data Quality* in *Section 4: Deploying and Operating HydroCAT-EP*.
- The pump may not be turning on before each sample, if the Minimum Conductivity Frequency is set too high. See *Pump Operation* in *Section 2: Description of HydroCAT-EP*.

Problem 4: Salinity Spikes

Salinity is a function of conductivity, temperature, and pressure, and must be calculated from C, T, and P measurements made on the same parcel of water. Salinity is calculated and output by the HydroCAT-EP if it is enabled in the HydroCAT-EP Settings dialog.

[*Background information:* Salinity spikes in **profiling** (i.e., moving, fast sampling) instruments typically result from misalignment of the temperature and conductivity measurements in conditions with sharp gradients. This misalignment is often caused by differences in response times for the temperature and conductivity sensors, and can be corrected for in post-processing if the T and C response times are known.]

In **moored**, pumped instruments such as the HydroCAT-EP, the pump flushes the conductivity cell at a faster rate than the environment changes, so the T and C measurements stay closely synchronized with the environment (i.e., even slow or varying response times are not significant factors in the salinity calculation). More typical causes of salinity spikes in a moored HydroCAT-EP include:

Cause/Solution 1: Severe external bio-fouling can restrict flow through the conductivity cell to such an extent that the conductivity measurement is significantly delayed from the temperature measurement.

Cause/Solution 2: For a HydroCAT-EP moored at shallow depth, differential solar heating can cause the actual temperature inside the conductivity cell to differ from the temperature measured by the thermistor. Salinity spikes associated mainly with daytime measurements during sunny conditions may be caused by this phenomenon.

Cause/Solution 3: For a HydroCAT-EP moored at shallow depth, air bubbles from breaking waves or spontaneous formation in supersaturated conditions can cause the conductivity cell to read low of correct.

Problem 5: HCO Wiper Arm Malfunction

The symptom of this problem is a wiper arm that does not move or moves weakly.

Cause/Solution 1: Adjust the wiper arm as follows -

1. Loosen the screw on the side of the wiper arm, using a 3/32" hex wrench.
2. Pull the wiper arm up the stainless steel shaft until there is a visible gap between the wiper blade and the face of the instrument.
3. Take a measurement (send **TS** in UCI Command Terminal). If the wiper arm moves, go to Step 4 to set the wiper height.
 - If the wiper arm does not move, contact Sea-Bird to arrange return of the HydroCAT-EP for servicing.
4. Slide the wiper arm onto the stainless shaft until the flat edge of the blade just touches the copper faceplate. Tighten the screw with a 3/32" hex wrench.
5. Take a measurement (send **TS** in UCI Command Terminal). If the wiper arm moves, the adjustment was successful.
6. If the wiper arm does not move now, but did move when the wiper was not touching the face (Step 3), there is too much friction. See *Section 5: Routine Maintenance and Calibration* for details on the following steps.
 - A. Remove the wiper arm and install a new wiper blade.
 - B. Clean the optics face.
 - C. Install the wiper arm, tighten the screw, and check that the blade is touching the copper face but is not flexed.
7. Take a measurement (send **TS** in UCI Command Terminal). If the wiper arm moves, the adjustment was successful.
 - If the wiper arm does not move, contact Sea-Bird to arrange return of the HydroCAT-EP for servicing.

Problem 6: HCO Calibration Check Failure

Cause/Solution 1: HCC (calibration check cap) may be installed incorrectly. Cap must be on straight, with the pin engaged in the notch.



Cause/Solution 2: HCO optics or HCC orange glass may be dirty. See cleaning instructions in *Optics Maintenance – HCO and HCC (check cap)* in *Section 5: Routine Maintenance and Calibration*.

Cause/Solution 3: HCO or HCC may be too hot or cold. **For the calibration check to be valid, the HCO and HCC must be between 18 and 26 °C** (cold temperatures cause high fluorometer and low turbidity readings; hot temperatures cause low fluorometer and high turbidity readings). **Allow at least 1 hour for the HCO and HCC to equilibrate before the calibration check.**

Note:

See *Appendix V: Sources of Variability in HCO Calibration Check* for a detailed discussion of variation due to temperature.

- If working in a sunny location on a warm day, redo the calibration check in a shady location or indoors.
- If working outdoors on a cold day, redo the calibration check indoors.

Glossary

Battery pack – 12 AA lithium cells in a battery holder that connects 4 cells in series and each series string in parallel. Battery pack uses:

- Saft LS 14500, AA, 3.6 V and 2.6 Amp-hours each (www.saftbatteries.com) (**recommended**),
- Tadiran TL-4903, AA, 3.6 V and 2.4 Amp-hours each (www.tadiran.com), or
- Electrochem 3B0064/BCX85, AA, 3.9 V and 2.0 Amp-hours each (www.electrochemsolutions.com)

Fouling – Biological growth on sensors during deployment.

HCC – HydroCAT-EP Check Cap used to calibration check of HCO (fluorescence and turbidity sensor).

HCO – HydroCAT-EP Optics (optional integrated fluorescence and turbidity sensor).

PCB – Printed Circuit Board.

Scan – One data sample containing user-selected measured and derived variables.

CAUTION:

Do not use Parker O-Lube, which is petroleum based; use only Super O-Lube.

Super O-Lube – Silicone lubricant used to lubricate O-rings and O-ring mating surfaces. Super O-Lube can be ordered from Sea-Bird, but should also be available locally from distributors. Super O-Lube is manufactured by Parker Hannifin (www.parker.com/ead/cm2.asp?cmid=3956).

TCXO – Temperature Compensated Crystal Oscillator.

Triton X-100 – Reagent grade non-ionic surfactant (detergent), used for cleaning the conductivity cell. Triton can be ordered from Sea-Bird, but should also be available locally from chemical supply or laboratory products companies. Triton is manufactured by Avantor Performance Materials (www.avantormaterials.com/commerce/product.aspx?id=2147509608).

UCI – Universal Coastal Interface; software designed for communications, setup, data viewing, and data upload from HydroCAT-EP.

Appendix I: Functional Description

Sensors

The HydroCAT-EP embodies the same conductivity and temperature sensor elements (3-electrode, 2-terminal, borosilicate glass cell, and pressure-protected thermistor) previously employed in Sea-Bird Electronics' modular SBE 3 and SBE 4 sensors and SeaCAT and SeaCAT*plus* family.

Note:

Pressure ranges are expressed in meters of deployment depth capability.

The HydroCAT-EP's optional strain-gauge pressure sensor is available in the following pressure ranges: 20, 100, and 350 meters. Compensation of the temperature influence on pressure offset and scale is performed by the HydroCAT-EP's CPU.

The HydroCAT-EP's optional Optical Dissolved Oxygen sensor is an SBE 63 Dissolved Oxygen sensor, with the same performance specifications.

The HydroCAT-EP's pH sensor is based on Hach's glass-bulb technology.

The HydroCAT-EP's optional fluorometer and turbidity sensor is an integrated HCO, based on WET Labs' ECO sensor technology. The HydroCAT-EP takes 30 HCO measurements at 1 Hz, requiring 30 seconds; output includes the average and the standard deviation of the 30 measurements. Measurement of other parameters occurs after the HCO measurements are complete.

Conductivity and Temperature Sensor Interface

Temperature is acquired by applying an AC excitation to a hermetically sealed VISHAY reference resistor and an ultra-stable aged thermistor with a drift rate of less than 0.002°C per year. A 24-bit A/D converter digitizes the outputs of the reference resistor and thermistor (and optional pressure sensor). AC excitation and ratiometric comparison using a common processing channel avoids errors caused by parasitic thermocouples, offset voltages, leakage currents, and reference errors.

Conductivity is acquired using an ultra-precision Wien Bridge oscillator to generate a frequency output in response to changes in conductivity.

Real-Time Clock

To minimize power and improve clock accuracy, a temperature-compensated crystal oscillator (TCXO) is used as the real-time-clock frequency source. The TCXO is accurate to ± 1 minute per year (0 °C to 40 °C).

HCO Calibration Process

Chlorophyll Calibration

The factory calibration process for the HCO's chlorophyll sensor uses reference sensors that are calibrated to extracted chlorophyll measurements from a culture of *Thalassiosira weissflogi* provided by Oregon State University. Production instruments are calibrated to a reference sensor using target solutions of uranine dye in deionized water. The calibration method is designed to minimize the influences of the environment on the calibration such that the most significant variance is that of the production instrument itself. The calibration then serves as the method to assure that each instrument as delivered is consistent with all other HCO production instruments.

The factory calibration process follows:

1. Record the reference sensor and production instrument dark counts.
2. Insert the reference sensor and the production instrument sequentially into target solutions of uranine dye. Record the output in counts for each target solution.
3. Calculate the effective chlorophyll concentration in the target solution at each step by multiplying the reference sensor net counts (observed - dark) by the reference sensor scale factor (ug/l Chl/count).
4. Calculate the production instrument scale factor using regression models across the entire range of the instrument.

Stability of the reference sensor is tracked over time using secondary standards.

Accuracy of the production instrument is determined by comparing multiple calculated scale factors using independent sets of calibration samples.

Turbidity (NTU) Calibration

The factory calibration process for the HCO's turbidity sensor uses a Hach 2100AN reference unit and Hach formazin turbidity standard. Each HCO is characterized so that HCO responses are uniform across the population of HCOs to a given target environment.

For all HCO production sensors, NTU counts are tied to the Hach 2100AN reference using a formazin solution. The factory calibration process follows:

1. Suspend the HCO in a black matte cylinder filled with formazin solution, with a collar that holds the HCO in the center of the cylinder. The formazin is continuously circulated in the cylinder.
2. Record the HCO output in counts.
3. Record the HCO dark counts.
4. Subtract the dark counts from the output.
5. Determine the effective NTU concentration in the target solution by measuring an aliquot of the target solution in a Hach 2100 AN.
6. Calculate the HCO NTU scale factor by least squares fit of Hach 2100AN value to the HCO net counts (observed – dark), for each gain stage.

Appendix II: Electronics Disassembly/Reassembly

CAUTION:

See *Section 5: Routine Maintenance and Calibration* for handling instructions for the plastic housing.

Disassembly:

1. Remove the connector end cap and battery pack following instructions in *Section 3: Preparing HydroCAT-EP for Deployment*.
2. Loosen the two captured 5/32" cap screws holding the copper anti-foulant assembly to the housing clamp, using the 5/32-inch Allen wrench (supplied). Carefully remove the copper anti-foulant assembly.



3. Remove the two Phillips-head screws and insulators holding the cell guard to the clamp.

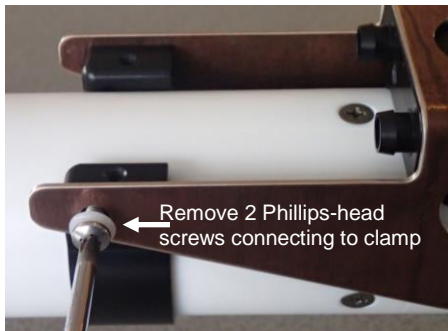

4. Remove the three Phillips-head screws holding the housing to the end cap.

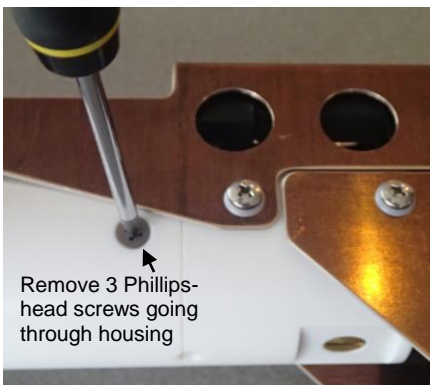

5. Put one of the removed cap screws from the **connector** end cap in the machined detail. Hold the cell guard and **carefully** twist the housing; the housing will release from the end cap.

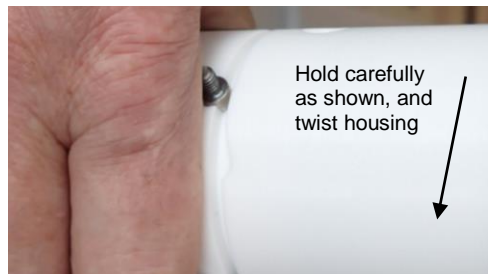

- 6. The electronics are on a sandwich of rectangular PCBs. These PCBs are assembled to a bulkhead. To remove the PCB assembly:
 - A. Use a small Phillips-head screwdriver (#1) to remove the Phillips-head threaded rod (198 mm [7.8 inch]).
 - B. Holding the edges of the PCB assembly, carefully pull it out from the edge connector.

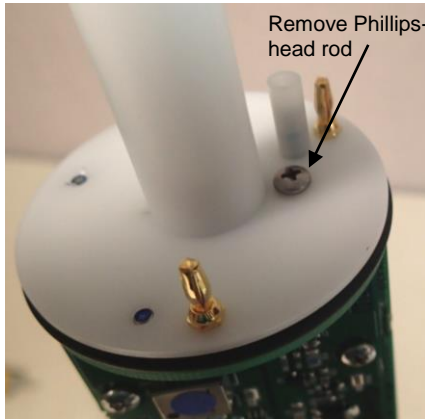

Hold edges of PCB assembly and carefully pull

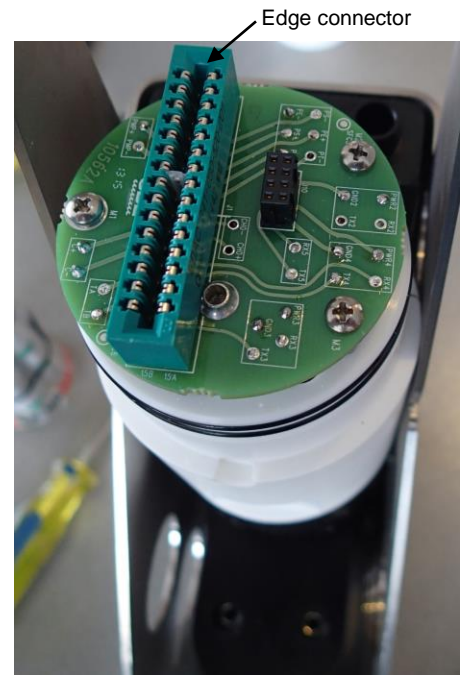
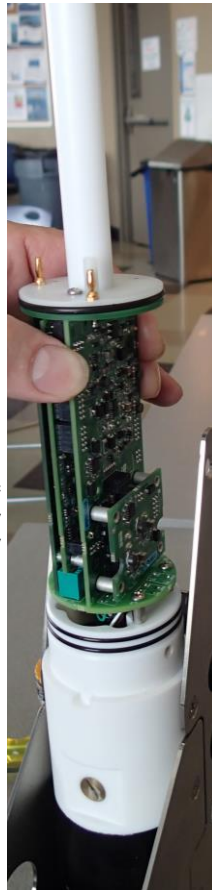

Reassembly:

- 1. Replace the PCB assembly as shown at left. Place LocTite® 222 on the bottom two threads on the Phillips-head rod; insert and tighten gently. A gentle resistance can be felt as the PCB assembly mates to the edge connector. If the rod will not tighten, the PCBs have not fully mated or are mated in reverse.

Replace PCB assembly on edge connector



Threaded Phillips-head rod

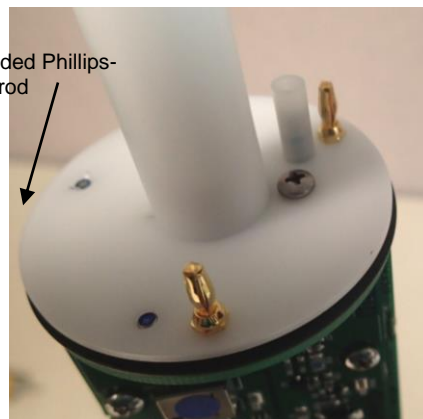

Note:

Before delivery, a desiccant package is inserted in the housing and the electronics chamber is filled with dry Argon gas to help prevent condensation. To ensure proper functioning:

1. Install a new desiccant bag each time you open the electronics chamber. If a new bag is not available, see *Application Note 71: Desiccant Use and Regeneration (drying)*.
2. If possible, dry gas backfill each time you open the housing. If you cannot, wait at least 24 hours before redeploying, to allow the desiccant to remove any moisture.

Note that opening the battery compartment does not affect desiccation of the electronics.

CAUTION:

Do not use Parker O-Lube, which is petroleum based; use only Super O-Lube.

2. Replace the housing on the end cap:
 - A. Remove any water from the O-rings and mating surfaces with a lint-free cloth or tissue. Inspect the O-rings and mating surfaces for dirt, nicks, and cuts. Clean as necessary. Apply a light coat of O-ring lubricant (Parker Super O Lube) to the O-rings and mating surfaces.
 - B. Carefully fit the housing onto the end cap until the O-rings are fully seated.
 - C. Reinstall the three Phillips-head screws to secure the housing.

3. Reinstall the two Phillips-head screws and insulators to connect the clamp to the cell guard.
4. Replace the copper anti-foulant assembly on the housing. Secure the assembly to the housing with the two captured cap screws; alternate tightening the screws to secure, maintaining even gaps on the sides.
5. Reinstall the battery pack and end cap following instructions in *Section 3: Preparing HydroCAT for Deployment*.

Push copper anti-foulant assembly while tightening captured cap screws

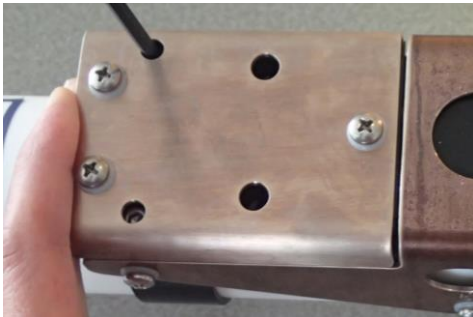

Appendix III: RS-232 Command Summary and Details

This section describes all commands that can be sent to the HydroCAT-EP via RS-232 (through a terminal program, such as **Command Terminal** in UCI). It is meant for reference for advanced users; most setup commands can be more easily sent through the UCI software. The Appendix is in two parts:

- Command Summary provides a quick reference list of commands, with brief explanations.
- Detailed Command Descriptions provides more information about the commands (notes, examples, sample outputs, etc.).

Entries made with the commands are permanently stored in the HydroCAT-EP and remain in effect until you change them. When entering commands:

- Input commands to the HydroCAT-EP in upper or lower case letters and register commands by pressing the Enter key. Note that commands are shown with a mix of upper and lower case for ease in reading (for example, **MinCondFreq=**), but do not need to be entered that way.
- The HydroCAT-EP sends an error message if an invalid command is entered.
- Commands to enable a parameter (such as enabling salinity output) can be entered with the *argument* as Y or 1 for yes, and N or 0 for no (for example, **OutputSal=y** and **OutputSal=1** are equivalent; both enable salinity output).
- If a new command is not received within 2 minutes after the completion of a command, the HydroCAT-EP returns to the quiescent (sleep) state.
- If in quiescent (sleep) state, re-establish communications pressing the Enter key.
- If the HydroCAT-EP is transmitting data and you want to stop it, press the Esc key or type ^C. Then press the Enter key.
- The HydroCAT-EP responds only to **GetCD**, **GetSD**, **GetCC**, **GetEC**, **GetHD**, **DS**, **DC**, **TS**, **TPS**, **SL**, **QS**, and **Stop** while sampling autonomously (**StartNow** has been sent). If you wake the HydroCAT-EP while it is pumping or sampling (for example, to send **DS** to check on progress):
 - (if **OutputExecutedTag=Y**) The HydroCAT-EP responds with one or more `<Executing>` tags until the sample is complete, and then responds to the command.
 - (if **OutputExecutedTag=N**) The HydroCAT-EP responds to the command after the sample is complete.
- The HydroCAT-EP responds only to **GetCD**, **GetSD**, **GetCC**, **GetEC**, **GetHD**, **DS**, **DC**, **TS**, **TPS**, **SL**, **QS**, and **Stop** while waiting to start autonomous sampling (**StartLater** has been sent). To send any other commands, send **Stop**, send the desired commands to modify the setup, and then send **StartLater** again.

Command Summary

CATEGORY	COMMAND	DESCRIPTION
Status	GetCD	Display configuration data.
	GetSD	Display status data.
	GetCC	Display calibration coefficients.
	GetEC	Display event counter data.
	ResetEC	Reset event counter.
	GetHD	Display hardware data.
	Help	Display list of currently available commands.
	DS	Display status and configuration data.
	DC	Display calibration coefficients.
	pHCalHist	Display pH sensor calibration history associated with logged data.
General Setup	DateTime=mmddyyhhmmss	Set real-time clock month, day, year, hour, minute, second.
	BaudRate=x	x = baud rate for RS-232 communications: 600*, 1200*, 2400*, 4800, 9600, 19200, 38400, 57600, or 115200 (*600, 1200, 2400 valid only if oxygen sensor not installed). Default 19200. <i>Note: 1200 baud is used for SDI-12 communication, independent of baud set for RS-232 communication.</i>
	ReferencePressure=x	x = reference pressure (gauge, dbar), used for conductivity, specific conductivity, oxygen, salinity, and sound velocity calculation when HydroCAT-EP does not have pressure sensor.
	*Default	Reset most user-input settings to factory defaults.
	ReSync	Update HydroCAT-EP with latest information from integrated SBE 63, HCO (fluorometer and turbidity), and pH sensors. Retrieves serial numbers and calibration coefficients from sensors.
	QS	Enter quiescent (sleep) state. Main power turned off, but data logging and memory retention unaffected.
RS-232 Setup	OutputExecutedTag=x	x=Y : Display XML Executing and Executed tags for RS-232 communications. x=N : Do not.
	TxRealTime=x	x=Y : Output real-time data for RS-232 communications while sampling autonomously. x=N : Do not.
SDI-12 Setup	SetAddress=x	x = address (0-9, a-z, A-Z) for SDI-12 communications. Command must be sent twice.
	SetSDI12Flag=x	x = out-of-range value (-9999999 to +9999999; must include + or - sign) for SDI-12 communications (OutputFormat=3). Default +9999999 . If HydroCAT-EP calculates out of range data for a particular parameter, this value is inserted in data stream for that parameter.

CATEGORY	COMMAND	DESCRIPTION
Pump Setup	MinCondFreq=x	x= Minimum Conductivity Frequency (Hz) to enable pump turn-on. Default factory setting (Zero Conductivity Frequency + 1 Hz).
	Preflush=x	x= time (sec) for pump to run before taking first sample. Range 300 – 600 sec; default 300 sec. <ul style="list-style-type: none"> • If autonomous sampling is started with StartNow, pre-flush pumping starts immediately. • If autonomous sampling is started with StartLater, pre-flush pumping starts x sec before scheduled start time. • For polled sampling, pre-flush pumping starts at PreflushStartTime=.
	PreflushStartTime=mmddyyyhhmm	Set delayed pre-flush start month, day, year, hour, minute for polled sampling. PreflushStartTime=0 disables pre-flush for polled sampling.
	OxNTau=x	x= pump time multiplier (0 – 100.0). Default 7.0.
	PumpTime=x	x= pump on time for each sample when oxygen sensor is installed. Range 0 - 550; default [OxNTau * SetTau20].
	PumpOn	Turn pump on for testing or to remove sediment. (pump turns off when PumpOff sent or 2 minutes without communications have elapsed)
	PumpOff	Turn pump off, if turned on with PumpOn.
SBE 63 Optical DO Sensor Setup	Send63:command	Command HydroCAT-EP to send command to SBE 63 and receive response (command can be any command recognized by SBE 63).
	Other commands	See SBE 63 manual for command list. Following setup of SBE 63 is required for use with HydroCAT-EP: SetEcho=1, SetFormat=1, SetAvg=1 to 16 (recommended value is 2), SetAutoRun=0.
HCO (fluorometer and turbidity) Sensor Setup	GetOpticsRef	Get check cap reference values from last calibration, which were stored in HCO. HCO sends 6 measurements (fluorescence counts at gain settings of 1, 5, and 25 followed by turbidity counts at gain settings of 1, 5, and 25) plus calibration date and check cap serial number.
	SetOpticsRef=x	x= new HCO check cap reference values; 6 measurements (fluorescence counts at gain settings of 1, 5, and 25 followed by turbidity counts at gain settings of 1, 5, and 25) plus calibration date and check cap serial number.
Memory Setup	InitLogging	Initialize logging to make entire memory available for recording and clear pH sensor calibration history. Command must be sent twice.
	RecoverSamples	Restore pointer to last sample in memory and restore pH sensor calibration history; useful if you sent InitLogging accidentally. Command must be sent twice.

Note:

Commands that enable/disable parameter outputs (date and time, temperature, conductivity, pressure, oxygen, pH, fluorescence, turbidity, salinity, sound velocity, specific conductivity, percent oxygen saturation, sample number) only apply if **OutputFormat=1, 2, or 3**. Raw output (**OutputFormat=0**) is not affected by enabling / disabling parameter outputs.

CATEGORY	COMMAND	DESCRIPTION
Output Format Setup	OutputFormat=x	x=0: Output raw decimal data. x=1: Output converted decimal data x=2: Output converted decimal data in XML format. x=3: Output converted decimal data in SDI-12 format.
	OutputTemp=x	x=Y: Output temperature. x=N: Do not.
	SetTempUnits=x	x=0: Temperature °C, ITS-90. x=1: Temperature °F, ITS-90.
	OutputCond=x	x=Y: Output conductivity. x=N: Do not.
	SetCondUnits=x	x=0: Conductivity and specific conductivity S/m. x=1: Conductivity and specific conductivity mS/cm. x=2: Conductivity and specific conductivity µS/cm.
	OutputPress=x	x=Y: Output pressure (if pressure sensor installed). x=N: Do not.
	SetPressUnits=x	x=0: Pressure decibars. x=1: Pressure psi (gauge).
	OutputOx=x	x=Y: Output oxygen (if oxygen sensor installed). x=N: Do not.
	SetOxUnits=x	x=0: Oxygen ml/L. x=1: Oxygen mg/L.
	OutputpH=x	x=Y: Output pH. x=N: Do not.
	OutputFl=x	x=Y: Output fluorescence (µg/L). x=N: Do not.
	OutputTbd=x	x=Y: Output turbidity (NTU). x=N: Do not.
	OutputSal=x	x=Y: Calculate and output salinity (psu). x=N: Do not.
	OutputSV=x	x=Y: Calculate and output sound velocity (m/sec). x=N: Do not.
	OutputSC=x	x=Y: Calculate and output specific conductivity. x=N: Do not.
		UseSCDefault=x
	SetSCA=x	<i>Only applicable if OutputSC=y and UseSCDefault=0.</i> x= thermal coefficient of conductivity for natural salt ion solutions (specific conductivity calculation).
	OutputOxSat=x	x=Y: Calculate and output oxygen saturation (%). x=N: Do not.
	TxSampleNum=x	x=Y: Output sample number with real-time data or with <i>polled</i> sample that is being stored to memory. x=N: Do not.

Note:
 You cannot set **SampleInterval=** to less than (pumping time + 38 sec) if HCO installed or less than (pumping time + 8 sec) if HCO **not** installed. See *Pump Operation in Section 2: Description of HydroCAT-EP* for details.

CATEGORY	COMMAND	DESCRIPTION
Autonomous Sampling (Logging)	SampleInterval=x	x= interval (sec) between samples (10 - 21600). <i>Default 900 sec.</i>
	StartNow	Start logging now.
	StartDateTime=mmddyyhhmmss	Delayed logging start: month, day, year, hour, minute, second.
	StartLater	Start logging at delayed logging start time.
Polled Sampling	Stop	Stop logging or waiting to start. Must stop before uploading data.
	TS	Do not pump. Take sample, store in buffer, output.
	TPS	Run pump, take sample, store in buffer, output.
	TPSS	Run pump, take sample, store in buffer and in FLASH memory, output.
	TSN:x	Do not pump. Take x samples (1 - 100) and output data.
	TPSN:x	Run pump continuously while taking x samples (1 - 100) and outputting data.
	SL	Output last sample in buffer.
	TempCheck:x	Run pump continuously while taking x samples (1 - 100) and outputting data. Allows rapid sampling to perform temperature sensor verification; values for pH, oxygen, oxygen saturation, and HCO not valid.
	CondCheck:x	Do not pump. Take x samples (1 - 100) and outputting data. Allows rapid sampling to perform conductivity sensor verification; values for pH, oxygen, oxygen saturation, and HCO not valid.
	T63	Do not pump. Take sample from SBE 63, output oxygen data in format set by SetFormat= in <i>SBE 63</i> .
	TOptics	Do not pump. Take 1 set of 30 samples from HCO (fluorometer and turbidity sensor), output HCO data in format set in <i>HCO</i> .
OpticsStats	Output average and standard deviation results of previous TOptics command.	
Data Upload (send Stop before sending upload command)	GetSamples:b,e	Upload scan b to e , format defined by OutputFormat= . Maximum of 5000 samples can be uploaded at one time.
Coefficients (F=floating point number; S=string with no spaces) Dates shown are when calibrations were performed. Calibration coefficients are initially factory-set and should agree with Calibration Certificates shipped with HydroCAT-EPs. View all coefficients with GetCC or DC .	TCalDate=S	S=Temperature calibration date.
	TA0=F	F=Temperature A0.
	TA1=F	F=Temperature A1.
	TA2=F	F=Temperature A2.
	TA3=F	F=Temperature A3.
	CCalDate=S	S=Conductivity calibration date.
	CG=F	F=Conductivity G.
	CH=F	F=Conductivity H.
	CI=F	F=Conductivity I.
	CJ=F	F=Conductivity J.
	WBOTC=F	F=Conductivity wbotc.
	CTCor=F	F=Conductivity ctcor.
	CPCor=F	F=Conductivity cpcor.
	CZ=F	F=Conductivity Zero Conductivity Frequency (Hz).
	PCalDate=S	S=Pressure calibration date.
	PA0=F	F=Pressure A0.
	PA1=F	F=Pressure A1.
	PA2=F	F=Pressure A2.
	PTCA0=F	F=Pressure ptca0
	PTCA1=F	F=Pressure ptca1.
	PTCA2=F	F=Pressure ptca2.
PTCB0=F	F=Pressure ptcb0.	
PTCB1=F	F=Pressure ptcb1.	
PTCB2=F	F=Pressure ptcb2.	
PTempA0=F	F=Pressure temperature a0.	
PTempA1=F	F=Pressure temperature a1.	
PTempA2=F	F=Pressure temperature a2.	
POffset=F	F=Pressure offset (decibars).	

Detailed Command Descriptions

Status Commands

Notes:

- **GetCD** output does not include calibration coefficients. To display calibration coefficients, use the **GetCC** command.
- Lines describing what parameters to output (temperature, conductivity, pressure, oxygen, pH, fluorescence, turbidity, salinity, sound velocity, specific conductivity, percent oxygen saturation, sample number) only appear if **OutputFormat=1, 2, or 3**. Raw output (**OutputFormat=0**) is not affected by enabling / disabling parameter outputs.

Note:

Preflush start time applies only to polled sampling (preflush occurs automatically at the start of autonomous sampling). Preflush start time for polled sampling says *start of logging* if disabled.

GetCD

Get and display configuration data, which includes parameters related to HydroCAT-EP setup. Most of these parameters can be user-input/modified. List below includes, where applicable, command used to modify parameter:

- Device type, Serial number
- Pressure sensor installed?
- Reference pressure (dbar) to use in calculations if no pressure sensor installed (only sent if pressure not installed) [**ReferencePressure=**]
- Output data format [**OutputFormat=**]
- Frame sync [factory-set]
- Units for:
 - temperature [**SetTempUnits=**], conductivity and specific conductivity [**SetCondUnits=**], pressure [**SetPressUnits=**], oxygen [**SetOxUnits=**]
- Output with each sample:
 - temperature [**OutputTemp=**]?
 - conductivity [**OutputCond=**]?
 - pressure [**OutputPress=**]?
 - oxygen [**OutputOx=**]?
 - pH [**OutputpH=**]?
 - fluorescence [**OutputFl=**]?
 - turbidity [**OutputTbd=**]?
 - salinity [**OutputSal=**]?
 - sound velocity [**OutputSV=**]?
 - specific conductivity [**OutputSC=**]?
- Specific conductivity temperature coefficient [**UseSCDefault=** and **SetSCA=**]
- Output oxygen percent saturation [**OutputOxSat=**]?
- Output sample number with real-time autonomous data and polled data from memory [**TxSampleNum=**]?
- Interval between samples for autonomous sampling [**SampleInterval=**]
- Transmit autonomous data real-time [**TxRealTime=**]?
- Minimum Conductivity Frequency for pump turn-on [**MinCondFreq=**]
- Pump-on time for each measurement [**OxNTau * SetTau20 = PumpTime**] (only sent if oxygen installed).
- Pump pre-flush time for first sample [**Preflush=**] and pre-flush start time for polled sampling [**PreflushStartTime=**]
- SDI-12 address [**SetAddress=**]
- Out of range value for **OutputFormat=3** and SDI-12 communications [**SetSDI12Flag=**]

Status Commands (*continued*)

Example: HydroCAT-EP with all optional sensors installed (user input in bold, command used to modify parameter in parentheses).

GETCD

```

<ConfigurationData DeviceType='HydroCAT-EP' SerialNumber = '03710103'>
  <PressureInstalled>yes</PressureInstalled>                (inclusion of pressure sensor set at factory)
  <SampleDataFormat>converted engineering</SampleDataFormat>  [OutputFormat=]
                                                                [factory-set]
  <FrameSync>HCEP</FrameSync>                                [SetTempUnits=]
                                                                [SetCondUnits=]
  <TemperatureUnits>Celsius</TemperatureUnits>              [SetPressUnits=]
                                                                [SetOxUnits=]
  <ConductivityUnits>µS/m</ConductivityUnits>                [OutputTemp=]
                                                                [OutputCond=]
  <PressureUnits>Decibar</PressureUnits>                     [OutputPress=]
                                                                [OutputOx=]
  <OxygenUnits>mg/L</OxygenUnits>                             [OutputpH=]
                                                                [OutputFl=]
  <OutputTemperature>yes</OutputTemperature>                 [OutputTbd=]
                                                                [OutputSal=]
  <OutputConductivity>yes</OutputConductivity>               [OutputSV=]
                                                                [OutputSC=]
  <OutputPressure>yes</OutputPressure>                       [UseSCDefault= and SetSCA=]
                                                                [OutputOxSat=]
  <OutputOxygen>yes</OutputOxygen>                            [OutputOxSat=]
                                                                [TxSampleNum=]
  <OutputpH>yes</OutputpH>                                    [TxSampleNum=]
                                                                [SampleInterval=]
  <OutputFluorescence>yes</OutputFluorescence>              [TxRealTime=]
                                                                [MinCondFreq=]
  <OutputTurbidity>yes</OutputTurbidity>                     [PumpTime=, OxNTau=]
                                                                [PreflushStartTime=, Preflush=]
  <OutputSalinity>yes</OutputSalinity>                       [SetAddress=]
                                                                [SetSDI12Flag=]
  <OutputSV>yes</OutputSV>
  <OutputSC>yes</OutputSC>
  <SCCoeff>0.0200</SCCoeff>
  <OutputOxSat>yes</OutputOxSat>
  <TxSampleNumber>yes</TxSampleNumber>
  <SampleInterval>900</SampleInterval>
  <TxRealTime>yes</SampleInterval>
  <MinCondFreq>2411.0</MinCondFreq>
  <PumpOnTime>38.5</PumpOnTime>
  <Preflush start='30 Oct 2015 12:00:00'>300</Preflush>
  <SDI12Address>0</SDI12Address>
  <SDI12Flag>+9999999</SDI12Flag>
</ConfigurationData>

```

Status Commands (*continued*)

GetSD

Get and display status data, which contains data that changes while deployed. List below includes, where applicable, command used to modify parameter:

- Device type, Serial number
- Date and time [**DateTime=**] in ISO8601-2000 extended format (yyyy – mm-ddThh:mm:ss)
- Number of recorded events in event counter [reset with **ResetEC**]
- Voltages – main battery pack voltage and back-up lithium cell voltage
- Memory – [reset with **InitLogging**]
 - Number of bytes in memory
 - Number of samples in memory
 - Number of additional samples that can be placed in memory
 - Length (number of bytes) of each sample
- Logging status –
 - yes or no (to indicate whether it is currently logging data);
 - if applicable, reason that logging has stopped

Example: HydroCAT-EP with all optional sensors installed (user input in bold, command used to modify parameter in parentheses)

getsd

```

<StatusData DeviceType='HydroCAT-EP' SerialNumber=' 03712345'>
  <DateTime>2015-11-02T00:48:32</DateTime>                                [DateTime=]
  <EventSummary numEvents='0' />                                        [can clear with ResetEC=]
  <Power>
    <vMain>13.32</vMain>
    <vLith>3.19</vLith>
  </Power>
  <MemorySummary>
    <Bytes>0</Bytes>                                                    [can clear with InitLogging]
    <Samples>0</Samples>                                              [can clear with InitLogging]
    <SamplesFree>270600</SamplesFree>                                  [can clear with InitLogging]
    <SampleLength>62</SampleLength>
  </MemorySummary>
  <AutonomousSampling>no, stop command</AutonomousSampling>        [StartNow or StartLater, Stop]
</StatusData>

```

Note:

Dates shown are when calibrations were performed.

Status Commands (*continued*)**GetCC**

Get and display calibration coefficients, which are initially factory-set and should agree with Calibration Certificates shipped with HydroCAT-EP. pH, optional HCO, and optional oxygen sensor calibration coefficients in response sensor are coefficients programmed into integrated sensors.

Example: HydroCAT-EP with all optional sensors installed (user input in bold, command used to modify parameter in parentheses)

getcc

```
<CalibrationCoefficients DeviceType='HydroCAT-EP' SerialNumber='03712345'>
  <Calibration format='TEMP1' id='Temperature'>
    <SerialNum>03712345</SerialNum>
    <CalDate>04-Aug-15</CalDate> [TCalDate=]
    <A0>6.947802e-05</A0> [TA0=]
    <A1>2.615233e-04</A1> [TA1=]
    <A2>-1.265233e-06</A2> [TA2=]
    <A3>1.310479e-07</A3> [TA3=]
  </Calibration>
  <Calibration format='WBCOND0' id='Conductivity'>
    <SerialNum>03712345</SerialNum>
    <CalDate>04-Oct-15</CalDate> [CCalDate=]
    <G>-1.009121e+00</G> [CG=]
    <H>1.410162e-01</H> [CH=]
    <I>-2.093167e-04</I> [CI=]
    <J>3.637053e-05</J> [CJ=]
    <PCOR>-9.570000e-08</PCOR> [CTCor=]
    <TCOR>3.250000e-06</TCOR> [CPCor=]
    <WBOTC>1.954800e-05</WBOTC> [CWBOTC=]
    <Z>2.523500e+03</Z> [CZ=]
  </Calibration>
  <Calibration format='STRAIN0' id='Pressure'>
    <SerialNum>2478619</SerialNum>
    <CalDate>28-Oct-15</CalDate> [PCalDate=]
    <PA0>1.729067e+00</PA0> [PA0=]
    <PA1>1.415754e-01</PA1> [PA1=]
    <PA2>1.246912e-08</PA2> [PA2=]
    <PTCA0>2.243971e+00</PTCA0> [PTCA0=]
    <PTCA1>1.055267e+00</PTCA1> [PTCA1=]
    <PTCA2>-2.276308e-02</PTCA2> [PTCA2=]
    <PTCB0>1.003849e+02</PTCB0> [PTCB0=]
    <PTCB1>1.014510e-02</PTCB1> [PTCB1=]
    <PTCB2>-2.057110e-04</PTCB2> [PTCB2=]
    <PTEMPA0>5.669780e+01</PTEMPA0> [PTempA0=]
    <PTEMPA1>-5.474043e-02</PTEMPA1> [PTempA1=]
    <PTEMPA2>1.267908e-05</PTEMPA2> [PTempA2=]
    <POFFSET>0.000000e+00</POFFSET> [POffset= (decibars)]
    <PRANGE>0.000000e+00</PRANGE> [PRange= (psi)]
  </Calibration>
```

GetCC response continued on next page

Status Commands (*continued*)**GetEC**

Get and display event counter data, which can help to identify root cause of a malfunction. Event counter records number of occurrences of common timeouts, power-on resets, etc. Can be cleared with **ResetEC**. Possible events that may be logged include:

Event ID	Description
WatchdogReset	Watchdog timer expired. Reset vector interrupt detected.
PowerOnReset	Instrument has been power cycled.
HardReset	CPU reset pin triggered.
LowBatteryVoltage	Low battery voltage detected while sampling.
OutOfMemory	Memory detected as full. Unable to access a valid new block.
BufWrOflow	Write pointer overflow in buffer module.
BufRdOflow	Read pointer overflow in buffer module.
SampleAborted	Sample aborted mid-measurement
LoggingRestartPON	Logging restarted after power cycling.
LoggingMissedStartPON	Start time has been missed. Start logging on integer interval from scheduled start time.
ThermistorError	Invalid ADC reading indicates disconnected thermistor leads.
AlarmTooLong	Time to next autonomous sample exceeded maximum 6 hour sample interval; default to 5 sec.
AlarmTooShort	Interval is too soon; default to 5 sec.
PreflushSkewedStart	First autonomous sample was scheduled to take place before preflush completed.
PumpTimeTooLong	Pumping time would have caused sample timing to be skewed
SBE63NotFound	No response from SBE 63 oxygen sensor.
HCONotFound	No response from HCO (fluorometer & turbidity) sensor.
PHNotFound	No response from pH sensor.
PumpStalled	Pump may have stalled
HCOWiperPosition	HCO wiper did not find correct position prior to optics measurement.
HCOBadPacketSize	Unexpected number of samples received from HCO during optics measurement.
SBE63NotSampled	SBE 63 oxygen sensor excessive power draw; no sample taken.
HCONotSampled	HCO excessive power draw; no sample taken.
PHNotSample	pH sensor excessive power draw; no sample taken.

Example: (user input in bold, command used to modify parameter in parentheses)

getec

```
<EventCounters DeviceType='HydroCAT-EP' SerialNumber='03712345'>
  <EventSummary numEvents='1' />
  <Event type='PowerOnReset' count='1' />
</EventCounters>
```

[can clear with **ResetEC**]

[can clear with **ResetEC**]

ResetEC

Delete all events in event counter (number of events displays in **GetSD** response, and event details display in **GetEC** response).

Status Commands (*continued*)

GetHD

Get and display hardware data, which is fixed data describing HydroCAT-EP:

- Device type, Serial number
- Manufacturer
- Firmware version
- Firmware date
- PCB serial numbers and assembly numbers
- Manufacture date
- Sensor types and serial numbers

Example: HydroCAT-EP with all optional sensors installed (user input in bold)

```
gethd
<HardwareData DeviceType='HydroCAT-EP' SerialNumber='03700004'>
  <Manufacturer>Sea-Bird Electronics, Inc.</Manufacturer>
  <FirmwareVersion build='12423'>5.0.0</FirmwareVersion>
  <FirmwareDate>Sep 18 2015, 17:52:02</FirmwareDate>
  <CommandSetVersion>1.0</CommandSetVersion>
  <PCBAssembly PCBSerialNum='90434' AssemblyNum='41920' />
  <PCBAssembly PCBSerialNum='90435' AssemblyNum='41919' />
  <PCBAssembly PCBSerialNum='80415' AssemblyNum='41661' />
  <PCBAssembly PCBSerialNum='90436' AssemblyNum='41787' />
  <MfgDate> Oct 8 2015</MfgDate>
  <FirmwareLoader>Loader_PD003_v0.2.1</FirmwareLoader>
  <InternalSensors>
    <Sensor id='Temperature'>
      <type>temperature-1</type>
      <SerialNumber>03700004</SerialNumber>
    </Sensor>
    <Sensor id='Conductivity'>
      <type>conductivity-1</type>
      <SerialNumber>03700004</SerialNumber>
    </Sensor>
    <Sensor id='Pressure'>
      <type>strain-0</type>
      <SerialNumber>441581</SerialNumber>
    </Sensor>
    <Sensor id='Oxygen'>
      <type>oxygen-1</type>
      <SerialNumber>631035</SerialNumber>
    </Sensor>
  </InternalSensors>
  <ExternalSensors>
    <Sensor id='pH'>
      <type>pH-0</type>
      <SerialNumber>00032</SerialNumber>
      <PCBAssembly PCBSerialNum='LMC6442' AssemblyNum='41925C.1' />
      <MfgDate>21-JUL-2015</MfgDate>
    </Sensor>
    <Sensor id='HCO'>
      <type>wl-0</type>
      <SerialNumber>HCO-00024</SerialNumber>
      <FirmwareVersion>1.0.2</FirmwareVersion>
      <CheckCapSN>hcc-004</CheckCapSN>
    </Sensor>
  </ExternalSensors>
</HardwareData>
```

Help

Display list of currently available commands, which may be useful if you do not have access to the HydroCAT-EP manual. Command list depends on logging state. Many commands are not available while HydroCAT-EP is sampling autonomously or waiting to start autonomous sampling (**StartLater** has been sent).

Status Commands (*continued*)

Notes:

- The **DS** response contains similar information as the combined responses from **GetSD** and **GetCD**, but in a different format.
- Lines describing what parameters to output (temperature, conductivity, pressure, oxygen, pH, fluorescence, turbidity, salinity, sound velocity, specific conductivity, percent oxygen saturation, sample number) only appear if they are enabled, and if **OutputFormat=1, 2, or 3**. Raw output (**OutputFormat=0**) is not affected by enabling / disabling parameter outputs.

DS

Display operating status and setup.

List below includes, where applicable, command used to modify parameter.

- Firmware version, serial number, date and time [**DateTime=**].
- Main battery pack voltage and back-up lithium cell voltage.
- Number of samples in memory and available sample space in memory.
- Logging status (logging not started, logging data, not logging, or unknown).
- Interval between samples for autonomous sampling [**SampleInterval=**].
- Output data format [**OutputFormat=**].
- Output temperature [**OutputTemp=**? Temperature units [**SetTempUnits=**]
- Output conductivity [**OutputCond=**? Conductivity and specific conductivity units [**SetCondUnits=**]
- Output pressure [**OutputPress=**? Pressure units [**SetPressUnits=**]
- Output oxygen [**OutputOx=**? Oxygen units [**SetOxUnits=**]
- Output pH [**OutputpH=**?]
- Output fluorescence [**OutputFl=**? Factory-set fluorescence units ($\mu\text{g/L}$)
- Output turbidity [**OutputTbd=**? Factory-set turbidity units (NTU)
- Output salinity [**OutputSal=**? Factory-set salinity units (psu)
- Output sound velocity [**OutputSV=**? Factory-set sound velocity units (m/s)
- Output specific conductivity [**OutputSC=**? Conductivity and specific conductivity units [**SetCondUnits=**]
- Specific conductivity temperature coefficient [**UseSCDefault=** and **SetSCA=**]
- Output oxygen percent saturation [**OutputOxSat=**?]
- Transmit sample number with real-time autonomous data and polled data from memory [**TxSampleNum=**?]
- Transmit autonomous data real-time [**TxRealTime=**?]
- Reference pressure to use in calculations if no pressure sensor installed (only sent if pressure sensor not installed) [**ReferencePressure=**].
- Minimum Conductivity Frequency for pump turn-on [**MinCondFreq=**].
- Pump-on time for each measurement [**OxNTau * SetTau20 = PumpTime**] (only sent if oxygen installed).
- Pump pre-flush time for first sample [**Preflush=**] and pre-flush start time for polled sampling [**PreflushStartTime=**]
- SDI-12 address [**SetAddress=**].
- Out of range value for **OutputFormat=3** and SDI-12 communications [**SetSDI12Flag=**]

Note:

Preflush start time applies only to polled sampling (preflush occurs automatically at the start of autonomous sampling). Preflush start time for polled sampling says *at start of logging* if disabled.

Status Commands (continued)

Example: HydroCAT-EP with all optional sensors installed (user input in bold, command used to modify parameter in parentheses).

DS

HydroCAT-EP v5.0.0 SERIAL NO. 12345 23 Apr 2015 10:55:45	[DateTIme=]
vMain = 13.31, vLith = 3.19	
samplenumber = 61008, free = 172008	
not logging, stop command	
sample interval = 900 seconds	[SampleInterval=]
data format = converted engineering	[OutputFormat=]
output temperature, Celsius	[OutputTemp=, SetTempUnits=]
output conductivity, uS/cm	[OutputCond=, SetCondUnits=]
output pressure, Decibar	[OutputPress=, SetPressUnits=]
output oxygen, mg/L	[OutputOx=, SetOxUnits=]
output pH	[OutputpH=]
output fluorescence, ug/l	[OutputFl=]
output turbidity, NTU	[OutputTbd=]
output salinity, PSU	[OutputSal=, factory-set units]
output sound velocity, m/s	[OutputSV=, factory-set units]
output specific conductivity, uS/cm	[OutputSC=, SetCondUnits=]
user defined specific conductivity coefficient = 0.0200	[UseSCDefault= and SetSCA=]
output sample number	[TxSampleNum=]
output oxygen percent saturation	[OutputOxSat=]
transmit real time data = yes	[TxRealTime=]
minimum conductivity frequency = 3000.00	[MinCondFreq=]
pump on time 7.0 * 5.5 = 38.5 sec	[PumpTime=, OxNTau=]
preflush = 300 seconds at 30 Sep 2015 12:00:00	[PreflushStartTime=, Preflush=]
SDI-12 address = 0	[SetAddress=]
SDI-12 flag = +9999999	[SetSDI12Flag=]

Notes:

- The **DC** and **GetCC** responses contain the same information, but in different formats.
- Dates shown are when calibrations were performed.

Status Commands (*continued*)**DC**

Display calibration coefficients, which are initially factory-set and should agree with Calibration Certificates shipped with HydroCAT-EP. pH, optional HCO, and optional oxygen sensor calibration coefficients in response are coefficients programmed into integrated sensors.

Example: HydroCAT-EP with all optional sensors installed (user input in bold, command used to modify parameter in parentheses).

DC

HydroCAT-EP v5.0.0 12752

temperature: 04-Aug-15

TA0 = 6.947802e-05

TA1 = 2.615233e-04

TA2 = -1.265233e-06

TA3 = 1.310479e-07

conductivity: 04-Aug-15

G = -1.036689e+00

H = 1.444342e-01

I = -3.112137e-04

J = 3.005941e-05

CPCOR = -9.570001e-08

CTCOR = 3.250000e-06

WBOTC = 1.968100e-05

Z = 2.523500e+03

pressure S/N 2478619, range = 2901 psia, 03-Aug-15

PA0 = 0.000000e+00

PA1 = 0.000000e+00

PA2 = 0.000000e+00

PTCA0 = 0.000000e+00

PTCA1 = 0.000000e+00

PTCA2 = 0.000000e+00

PTCB0 = 0.000000e+00

PTCB1 = 0.000000e+00

PTCB2 = 0.000000e+00

PTEMPA0 = 0.000000e+00

PTEMPA1 = 0.000000e+00

PTEMPA2 = 0.000000e+00

POFFSET = 0.000000e+00

oxygen S/N 631035, 28-Aug-15

TAU_20 = 4.000000e+00

OXA0 = 1.051300e+00

OXA1 = -1.500000e-03

OXA2 = 4.161926e-01

OXB0 = -2.325492e-01

OXB1 = 1.692931e+00

OXC0 = 8.966704e-02

OXC1 = 3.617471e-03

OXC2 = 5.112384e-05

OXTA0 = 6.517293e-04

OXTA1 = 2.533749e-04

OXTA2 = 3.140482e-07

OXTA3 = 1.064506e-07

OXE = 1.100000e-02

[TCalDate=]

[TA0=]

[TA1=]

[TA2=]

[TA3=]

[CCalDate=]

[CG=]

[CH=]

[CI=]

[CJ=]

[CPCor=]

[CTCor=]

[CWBOTC=]

[CZ=]

[PRange= (psi), PCalDate=]

[PA0=]

[PA1=]

[PA2=]

[PTCA0=]

[PTCA1=]

[PTCA2=]

[PTCB0=]

[PTCB1=]

[PTCB2=]

[PTempA0=]

[PTempA1=]

[PTempA2=]

[POffset= (decibars)]

[SetCalDate= in SBE 63]

[SetTau20= in SBE 63]

[SetA0= in SBE 63]

[SetA1= in SBE 63]

[SetA2= in SBE 63]

[SetB0= in SBE 63]

[SetB1= in SBE 63]

[SetC0= in SBE 63]

[SetC1= in SBE 63]

[SetC2= in SBE 63]

[SetTA0= in SBE 63]

[SetTA1= in SBE 63]

[SetTA2= in SBE 63]

[SetTA3= in SBE 63]

[SetE= in SBE 63]

DC response continued on next page

Status Commands *(continued)*

DC response continued from previous page

```

pH S/N 00032, 07 May 2015
  SLOPE      = -1.740991e+09           [set by UCI as result of pH Calibration]
  OFFSET     = -1.105664e+07         [set by UCI as result of pH Calibration]
HCO S/N HCO-005, 9-apr-15
  F14        = 0.000000e+00           [factory-set]
  F13        = 0.000000e+00           [factory-set]
  F12        = 0.000000e+00           [factory-set]
  F11        = 1.994400e-01           [factory-set]
  F24        = 0.000000e+00           [factory-set]
  F23        = 0.000000e+00           [factory-set]
  F22        = 0.000000e+00           [factory-set]
  F21        = 3.704700e-02           [factory-set]
  F34        = 0.000000e+00           [factory-set]
  F33        = 0.000000e+00           [factory-set]
  F32        = 0.000000e+00           [factory-set]
  F31        = 6.962100e-03           [factory-set]
  FD1        = 51                     [factory-set]
  FD2        = 53                     [factory-set]
  FD3        = 54                     [factory-set]
  N14        = 1.459100e-13           [factory-set]
  N13        = 1.827600e-09           [factory-set]
  N12        = 1.384400e-05           [factory-set]
  N11        = 1.824100e-01           [factory-set]
  N24        = -4.007500e-15          [factory-set]
  N23        = 3.903100e-11          [factory-set]
  N22        = 7.548701e-07          [factory-set]
  N21        = 3.134800e-02           [factory-set]
  N34        = 0.000000e+00           [factory-set]
  N33        = 0.000000e+00           [factory-set]
  N32        = 2.747000e-08           [factory-set]
  N31        = 5.715400e-03           [factory-set]
  ND1        = 50                     [factory-set]
  ND2        = 51                     [factory-set]
  ND3        = 51                     [factory-set]

```

pHCalHist

Display pH sensor calibration history associated with logged data.

General Setup Commands

DateTime=mmddyymmss Set real-time clock month, day, year, hour, minute, second.

Example: Set current date and time to 10 November 2015 12:00:00 (user input in bold).

DATE TIME=11102015120000

Notes:

- The HydroCAT-EP baud rate (set with **BaudRate=**) must be the same as the terminal program's baud rate.
- **BaudRate=** must be sent twice. After the first entry, the HydroCAT-EP changes to the new baud, and then waits for the command to be sent again at the new baud. This prevents you from accidentally changing to a baud that is not supported by your computer. If it does not receive the command again at the new baud, it reverts to the previous baud rate.
- 1200 baud is used for SDI-12 communication, and is independent of baud set for RS-232 communication.

BaudRate=x

x= baud for **RS-232** communication: 600*, 1200*, 2400*, 4800, 9600, 19200, 38400, 57600, or 115200 (*600 - 2400 valid only if oxygen sensor not installed). **Default 19200**. Check capability of computer and terminal program before increasing baud; high baud requires short cable and good PC serial port with accurate clock. **Must be sent twice to change rate**. Length of cable that HydroCAT-EP can drive is baud-dependent. See *RS-232 Real-Time Data Acquisition* in *Section 4: Deploying and Operating HydroCAT-EP*.

ReferencePressure=x

x = reference pressure (gauge) in decibars. HydroCAT-EP without pressure sensor uses this in conductivity, specific conductivity, oxygen, salinity, and sound velocity calculations. Entry ignored if pressure sensor installed.

Default*Reset to defaults for user-input settings.**

- Logging status is 'never started'
- **InitLogging**
- **ResetEC**
- **ReferencePressure=0.0** (if pressure not installed)
- **OutputExecutedTag=Y**
- **TxRealTime=Y**
- **SetAddress=0**
- **SetSDI12Flag=+9999999**
- **MinCondFreq=Z** (zero conductivity frequency) + 1 Hz
- **Preflush=300**
- **PumpTime=38.5** (if oxygen installed)
- **TxSampleNum=N**
- **OutputFormat=1** (decimal, engineering units)
- **OutputTemp=Y**
- **SetTempUnits=0** (°C)
- **OutputPress=Y** (if pressure installed)
- **SetPressUnits=0** (decibars)
- **OutputSC=Y**
- **SetSCA=0.020**
- **SetCondUnits=2** (µS/cm)
- **OutputOx=Y** (if oxygen installed)
- **SetOxUnits=1** (mg/l)
- **OutputpH=Y**
- **OutputFl=Y**
- **OutputTbd=Y**
- **OutputCond=N**
- **OutputSV=N**
- **OutputSal=N**
- **OutputOxSat=N**
- **SampleInterval=900**

General Setup Commands (*continued*)

ReSync Update HydroCAT-EP with latest information from integrated pH, SBE 63, and HCO (fluorometer and turbidity) sensors. Retrieves serial numbers and calibration coefficients from sensors. Responds with sensor serial number, or *not found* if sync fails. View retrieved serial numbers in **GetHD**, and retrieved calibration coefficients in **GetCC**.

Note:

The HydroCAT-EP automatically enters quiescent state after 2 minutes without receiving a command. This timeout algorithm is designed to conserve battery pack energy if the user does not send **QS** to put the HydroCAT-EP to sleep.

QS Quit session and place HydroCAT-EP in quiescent (sleep) state. Main power is turned off. Autonomous sampling and memory retention are not affected.

RS-232 Setup Commands

These commands are not applicable for SDI-12 communications; executed tags and real-time autonomous sampling data are never output for SDI-12.

OutputExecutedTag=x **x=Y**: Display XML Executing and Executed tags for **RS-232** communications. Executed tag displays at end of each command response; Executing tag displays one or more times if HydroCAT-EP response to command requires additional time.

x=N: Do not output Executing and Executed tags.

Example: Set to output Executed and Executing tags (user input in bold).

```
outputexecutedtag=y
<Executed/>getcd
. . . (GetCD response)
<Executed/>
```

(Note: <Executed/> tag at end of command response takes place of S> prompt.)

Notes:

- The HydroCAT-EP always outputs real-time data for polled sampling.
- **TxRealTime=** does not affect storing data to memory, but slightly increases current consumption and time needed to sample (and then transmit) data.
- To capture real-time data to a file in UCI, click **Start** and then click **Start Logging to File** in the Data Logging: HydroCAT-EP console. Alternatively, use the Capture utility in any terminal program to save real-time data.

TxRealTime=x **x=Y**: Output real-time data for **RS-232** communications while sampling autonomously. Data is transmitted immediately after it is sampled.

x=N: Do not output real-time data.

SDI-12 Setup Commands

SetAddress=x **x=** address (0-9, a-z, A-Z) for **SDI-12** communications. **Must be sent twice to change address.**

SetSDI12Flag=x **x=** out-of-range value (-9999999 to +9999999; must include + or - sign) for **SDI-12** communications (**OutputFormat=3**). **Default +9999999**. If HydroCAT-EP calculates out of range data for a particular parameter, this value is inserted in data stream for that parameter. *Out-of-range* value is not applicable if **OutputFormat=0, 1, or 2**; it is factory set to *nan*.

Pump Setup Commands

Note:

See *Pump Operation* in *Section 2: Description of HydroCAT-EP* for details.

The HydroCAT-EP provides additional pumping time (**Preflush=**) at the beginning of a deployment to get air out of the plumbing and allow the pump to prime before taking the first measurement.

The integral pump is water lubricated; running it *dry* for an extended period of time will damage it. To prevent the pump from running dry while sampling, the HydroCAT-EP checks the raw conductivity frequency (Hz) from the last sample against the user-input minimum conductivity frequency (**MinCondFreq=**). If the raw conductivity frequency > **MinCondFreq**, it runs the pump before taking the sample; otherwise it does not run the pump.

If the Minimum Conductivity Frequency is too close to the *zero conductivity frequency* (from the HydroCAT-EP Calibration Sheet), the pump may turn on when the HydroCAT-EP is in air, as a result of small drifts in the electronics. Some experimentation may be required to control the pump, particularly in fresh water applications.

Notes:

- The HydroCAT-EP does not check **MinCondFreq** before running the pump for the pre-flush, because the purpose of the pre-flush is to remove air from the plumbing.
- For autonomous sampling, the first measurement is taken as soon as the pre-flush is completed, with no additional pumping time (i.e., the normal pumping time before each autonomous measurement is ignored for the first measurement, since the pre-flush time is longer).
- Preflush will end if during the preflush: you send a command that causes the pump to turn on or off (**TPS**, **TPSS**, **TPSN:x**, **StartNow**, **StartLater**, **PumpOn**, **PumpOff**, or **TempCheck:x**). The HydroCAT-EP will abort the preflush and execute the command.

Preflush=x

x= time (sec) for pump to run before taking **first** sample. Range 300 – 600 sec; *default 300 sec*. Provides additional pumping time at beginning of deployment to get air out of plumbing and allow pump to prime.

- If **autonomous** sampling is started with **StartNow**, pre-flush pumping starts immediately.
- If **autonomous** sampling is started with **StartLater**, pre-flush pumping starts **x** sec before scheduled start time.
- For **polled** sampling, pre-flush pumping starts at **PreflushStartTime=**.

PreflushStartTime= mmddyyyyhhmm

Set delayed pre-flush start month, day, year, hour, minute **for polled sampling**.

PreflushStartTime=0 disables pre-flush for polled sampling. **PreflushStartTime=** must be within 30 days of current date and time. To cancel scheduled preflush, press Esc key or send **Stop** command.

MinCondFreq=x

x= Minimum Conductivity Frequency (Hz) to enable pump turn-on, to prevent pump from running before HydroCAT-EP is in water. Pump does not run when conductivity frequency drops below **MinCondFreq=**. HydroCAT-EP Configuration Sheet lists uncorrected (raw) frequency output at 0 conductivity, which is called *Zero Conductivity Frequency*. *Zero Conductivity Frequency* can also be found by sending **GetCC** or **DC**; it is listed as *Z* in conductivity coefficient section of response.

Fresh water applications:

Typical **MinCondFreq=**
(Zero Conductivity Frequency + 1 Hz).
Default factory setting.

Salt water and estuarine applications:

Typical **MinCondFreq=**
(Zero Conductivity Frequency + 500 Hz).

Pump Setup Commands (*continued*)

Notes:

1. **SetTau20=** is the SBE 63 sensor response time, and is programmed **in the SBE 63**.
2. **OxNTau=**, and **PumpTime=** interact as shown in the examples. Either **OxNTau=** or **PumpTime=** can be used to define the pump time for each sample; HydroCAT-EP uses the last value entered to calculate and reset the other value (see examples below **PumpTime=**).

OxNTau=x

x= pump time multiplier when oxygen sensor installed. Range 0 – 100.0; **default 7.0**. See example below for interaction with **PumpTime=**.

PumpTime=x

x= pump on time for each sample when oxygen sensor is installed. Range 0 - 550; **default [OxNTau * SetTau20]**. See example below for interaction with **OxNTau=**.

Example 1: If oxygen sensor installed, and user sends **OxNTau=7.0** and **SetTau20=5.5** (sec), HydroCAT-EP sets **PumpTime=38.5** ($= 7.0 * 5.5$), and pump runs for 38.5 sec before each sample.

Example 2: If oxygen sensor installed, and user sends **OxNTau=7.0** and **SetTau20=5.5** (sec), HydroCAT-EP sets **PumpTime=38.5** ($= 7.0 * 5.5$). If user then sends **PumpTime=33**, HydroCAT-EP sets **OxNTau=6.0** ($= 33 / 5.5$), and pump runs for 33 sec before each sample.

CAUTION:

The HydroCAT-EP does not check **MinCondFreq** when you send **PumpOn**; **do not run the pump dry**. The pump is water lubricated; running it without water will damage it. If briefly testing your system with **PumpOn** in dry conditions, orient the HydroCAT-EP to provide an upright U-shape for the plumbing. Then fill the internal plumbing and inside of the pump head with water via the pump exhaust. This will provide enough lubrication to prevent pump damage during brief testing.

PumpOn

Turn pump on to test pump or remove sediment from inside plumbing. **Pump runs continuously, drawing current** (pump turns off when **PumpOff** sent or 2 minutes without communications have elapsed). **PumpOn** has no effect on pump operation while sampling.

PumpOff

Turn pump off if it was turned on with **PumpOn**. **PumpOff** has no effect on pump operation while sampling.

Optional SBE 63 Optical Dissolved Oxygen Sensor Setup Commands

Send63:command Command HydroCAT-EP to send **command** to SBE 63 and receive response; **command** can be any command recognized by SBE 63.

Example: Send **GetSD** command to SBE 63 to verify its setup (user input in bold).

```

send63:getsd
Sending SBE63: getsd
-----
getsd
<StatusData DeviceType = 'SBE063' SerialNumber = '0012'>
  <FirmwareVersion>3.2.2</FirmwareVersion>
  <LoaderVersion>SBE 63 FirmwareLoader V 1.0</LoaderVersion>
  <CalibrationDate>05535</CalibrationDate>
  <StatusConfig>
    <BaudRate>009600</BaudRate>
    <BlueOnTime>0000001</BlueOnTime>
    <SampleAvg>002</SampleAvg>
    <SampleInterval>00002</SampleInterval>
    <BootDelay>001</BootDelay>
    <OutFormat>01</OutFormat>
    <AnalogGain>2</AnalogGain>
    <AnalogOffset>06</AnalogOffset>
    <Autorun>0</Autorun>
    <BlueTupdate>0</BlueTupdate>
    <SerPause>1</SerPause>
    <Echo>1</Echo>
    <TxPwrSave>0</TxPwrSave>
    <Flags>0x0000</Flags>
  </StatusConfig>
</StatusData>
<Executed/>
    
```

Note:
 When using the SBE 63 integrated with a HydroCAT-EP, the following setup in the **SBE 63** is required:

- **SetBaud=9600** (factory set; cannot be changed by command through the HydroCAT-EP).
- **SetEcho=1**.
- **SetFormat=1**.
- **SetAvg=1 to 16; recommended value is 2**.
- **SetAutoRun=0**.
- <TxPwrSave> in SBE 63's **GetSD** or **GetHD** response is 0 (factory set; cannot be changed by command).

Commands that can be sent to the SBE 63 that are applicable to its use when integrated with the HydroCAT-EP are listed below with brief descriptions; see the SBE 63 manual for details.

GetSD	Get and display SBE 63 status data.
GetHD	Get and display SBE 63 hardware data.
GetCC	Get and display SBE 63 calibration coefficients
SetBaud=9600	Required SBE 63 setting for use with HydroCAT-EP.
SetFormat=1	Required SBE 63 setting for use with HydroCAT-EP.
SetAvg=x	x = number of measurements in SBE 63 to average per sample; each measurement takes approximately 0.03 sec. Increasing SetAvg= may shorten sensor film life. Required range for use with HydroCAT-EP is 1-16; recommended value 2.
SetAutoRun=0	Required SBE 63 setting for use with HydroCAT-EP.
*Default	Reset most SBE 63 Setup parameters to factory defaults. Baud (SetBaud=) is not reset.
TS	Take 1 SBE 63 sample, transmit data in format defined by SBE 63's SetFormat= .

Notes:

- The HydroCAT-EP pump does not run when **TS** or **TSR** is sent to the SBE 63. If desired, use **PumpOn** and **PumpOff** to turn the pump on and off.
- **Converted data in the SBE 63 response to Send63:TS is based on the calibration coefficients programmed into the SBE 63.**

Optional HCO (fluorometer and turbidity) Sensor Setup Commands

If the HCO is installed, the HydroCAT-EP takes 30 HCO measurements at 1 Hz for each sample, requiring 30 seconds. The output includes the average and the standard deviation of the 30 measurements.

GetOpticsRef Get check cap reference values from last calibration, which were stored in HCO. HCO sends 6 measurements (fluorescence counts at gain settings of 1, 5, and 25 followed by turbidity counts at gain settings of 1, 5, and 25) plus calibration date and check cap serial number.

Example:

```
getopticsref
234,1063,5687,442,2225,12023,13-apr-15,hco-cc003
<Executed/>
```

SetOpticsRef=x x= new HCO check cap reference values; 6 measurements (fluorescence counts at gain settings of 1, 5, and 25 followed by turbidity counts at gain settings of 1, 5, and 25) plus calibration date and check cap serial number.

Example:

```
setopticsref=234,1063,5687,442,2225,12023,13-apr-15
<Executed/>
```

Notes:

- If the FLASH memory is filled to capacity, sampling continues, but excess data is not saved in memory (i.e., the HydroCAT-EP does not overwrite data in memory).
- The HydroCAT-EP requires verification when **InitLogging** or **RecoverSamples** is sent. It responds with a request to repeat the command to confirm. Type the command again and press the Enter key to proceed.
- **Do not send InitLogging until all data has been uploaded.** **InitLogging** does not delete data; it just resets the data pointer. **If you accidentally send InitLogging before uploading**, recover the data by sending **RecoverSamples** and then uploading the data.

Memory Setup Commands

InitLogging

Initialize logging – after all previous data has been uploaded, initialize logging before starting to sample again to make entire memory available for recording. **InitLogging** sets sample number to 0 (sampling will start with sample 1) and clears pH sensor calibration history. If **InitLogging** not sent, data will be stored after last recorded sample. **Do not send InitLogging until all existing data has been uploaded.** HydroCAT-EP requires this command to be sent twice, to prevent accidental reset of memory.

RecoverSamples

Restore pointer to last sample in memory and restore pH sensor calibration history; useful if you sent **InitLogging** accidentally. Note that if you take and store samples in memory after sending **InitLogging** (i.e., the sample number in the **GetSD** or **DS** status responses is no longer 0), you cannot restore previous memory with **RecoverSamples**, because a sector of memory will already have been erased. HydroCAT-EP requires this command to be sent twice, to prevent accidental reset of memory.

Output Format Setup Commands

Notes:

- See *Data Formats* after the command descriptions.
- The HydroCAT-EO does not *store* salinity, sound velocity, specific conductivity, or percent oxygen saturation in memory when they are enabled. It calculates and outputs these derived parameters in real-time, when polled for data or as data is uploaded. Therefore, outputting these parameters has no effect on the number of samples that can be stored in memory.
- The pressure sensor is an absolute sensor, so its **raw** output (**OutputFormat=0**) includes the effect of atmospheric pressure (14.7 psi). However, when outputting pressure in **psi** or **decibars**, the HydroCAT-EP outputs pressure relative to the ocean surface (i.e., at the surface the output pressure is 0 psi or 0 dbar). The HydroCAT-EP uses the following equations to convert psia:

$$P(\text{psi}) = P(\text{psia}) - 14.7$$

$$P(\text{dbar}) = [P(\text{psia}) - 14.7] * 0.689476$$

OutputFormat=x	<p>x=0: Output raw decimal data.</p> <p>x=1: Output converted decimal data.</p> <p>x=2: Output converted decimal XML data.</p> <p>x=3: Output converted decimal data in format compatible with SDI-12. Note: HydroCAT-EP automatically outputs over SDI-12 line in this format; setting OutputFormat=3 allows you to view this format with RS-232 communications.</p>
OutputTemp=x	<p>x=Y: Output temperature (units defined by SetTempUnits=) with each sample if OutputFormat=1, 2, or 3.</p> <p>x=N: Do not.</p>
SetTempUnits=x	<p>x=0: Temperature output °C, ITS-90.</p> <p>x=1: Temperature output °F, ITS-90.</p>
OutputCond=x	<p>x=Y: Output conductivity (units defined by SetCondUnits=) with each sample if OutputFormat=1, 2, or 3.</p> <p>x=N: Do not.</p>
SetCondUnits=x	<p>x=0: Conductivity and specific conductivity output S/m.</p> <p>x=1: Conductivity and specific conductivity output mS/cm.</p> <p>2: Conductivity and specific conductivity output μS/cm.</p>
OutputPress=x	<p>x=Y: Output pressure (units defined by SetPressUnits=) with each sample if pressure sensor installed and OutputFormat=1, 2, or 3.</p> <p>x=N: Do not.</p>
SetPressUnits=x	<p>x=0: Pressure output decibars.</p> <p>x=1: Pressure output psi (gauge).</p>
OutputOx=x	<p>x=Y: Output oxygen (units defined by SetOxUnits=) with each sample if oxygen sensor installed and OutputFormat=1, 2, or 3.</p> <p>x=N: Do not.</p>
SetOxUnits=x	<p>x=0: Oxygen output ml/L.</p> <p>x=1: Oxygen output mg/L.</p>
OutputpH=x	<p>x=Y: Output pH with each sample if OutputFormat=1, 2, or 3.</p> <p>x=N: Do not.</p>

Output Format Setup Commands (*continued*)

OutputFl=x	<p>x=Y: Output fluorescence average and standard deviation with each sample if OutputFormat=1, 2, or 3.</p> <p>x=N: Do not.</p>
OutputTbd=x	<p>x=Y: Output turbidity average and standard deviation with each sample if OutputFormat=1, 2, or 3.</p> <p>x=N: Do not.</p>
OutputSal=x	<p>x=Y: Output salinity (psu) with each sample if OutputFormat=1, 2, or 3.</p> <p>x=N: Do not.</p>
OutputSV=x	<p>x=Y: Output sound velocity (m/sec) using Chen and Millero formula (UNESCO Technical Papers in Marine Science #44) with each sample, if OutputFormat=1, 2, or 3.</p> <p>x=N: Do not.</p>
OutputSC=x	<p>x=Y: Output specific conductivity (units defined by SetCondUnits=) with each sample, if OutputFormat=1, 2, or 3.</p> <p>x=N: Do not.</p>
UseSCDefault=x	<p><i>Only applicable if OutputSC=Y.</i></p> <p>x=0: Use value specified by SetSCA=.</p> <p>x=1: Use default value of 0.020 for thermal coefficient of conductivity for natural salt ion solutions (used in specific conductivity calculation).</p>
SetSCA=x	<p><i>Only applicable if OutputSC=Y and UseSCDefault=0.</i></p> <p>x= thermal coefficient of conductivity for natural salt ion solutions (used in specific conductivity calculation).</p>
OutputOxSat=x	<p>x=Y: Output oxygen saturation (%) with each sample, if OutputFormat=1, 2, or 3. Calculation of oxygen saturation is defined in <i>Calculation of Oxygen Saturation</i> later in this Appendix.</p> <p>x=N: Do not.</p>
TxSampleNum=x	<p>x=Y: Output sample number with real-time data or with <i>polled</i> sample that is being stored to memory if OutputFormat=1, 2, or 3.</p> <p>x=N: Do not.</p>

Note:

Specific conductivity
 $= C / (1 + A * [T - 25])$

where

- C = conductivity (same units as specific conductivity: $\mu\text{S/cm}$, mS/cm , or S/m)
- T = temperature ($^{\circ}\text{C}$)
- A = thermal coefficient of conductivity for natural salt ion solutions (default 0.020).

Autonomous Sampling (Logging) Commands

Notes:

- Autonomous sampling is not compatible with SDI-12 operation.
- If the HydroCAT-EP is logging data and the battery pack voltage is less than 7.1 volts for five consecutive scans, the HydroCAT-EP halts logging.
- If the FLASH memory is filled to capacity, sampling continues but excess data is not saved in memory (i.e., the HydroCAT-EP does not overwrite the data in memory).
- You cannot set **SampleInterval** to < (pumping time + 38 sec) if HCO installed or < (pumping time + 8 sec) if HCO not installed. See *Pump Operation in Section 2: Description of HydroCAT-EP* for details.

Logging commands direct the HydroCAT-EP to sample data at pre-programmed intervals and store the data in its FLASH memory. Pump operation is dependent on **MinCondFreq=**.

SampleInterval=x

x= interval (sec) between samples (10 – 21,600); *default 900 sec*. When commanded to start sampling with **StartNow** or **StartLater**, at **x** sec intervals HydroCAT-EP takes measurement (running pump before each measurement), stores data in FLASH memory, transmits real-time data (if communicating via RS-232 and **TxRealTime=Y**), and goes to sleep.

Notes:

- After receiving **StartLater**, the HydroCAT-EP displays `not logging: start at` in reply to **DS**. Once logging has started, the reply displays `logging`.
- If the delayed start date and time is less than (5 sec + **Preflush**) in the future when **StartLater** is received, the HydroCAT-EP delays the start of logging by adding multiples of **SampleInterval** to the programmed start date and time until there is enough time for the preflush to complete before the start of sampling.
- If the delayed start date and time has already passed when **StartLater** is received, the HydroCAT-EP executes **StartNow**.
- If the delayed start date and time is more than 30 days in the future when **StartLater** is received, the HydroCAT-EP assumes that the user made an error in setting the delayed start date and time, and it executes **StartNow**.

StartNow

Start logging now, at rate defined by **SampleInterval=**. Data is stored in FLASH memory. Data is transmitted real-time if connected via RS-232 and **TxRealTime=Y**.

StartDateTime=mmddyyyyhhmmss

Set delayed logging start month, day, year, hour, minute, second. HydroCAT-EP starts preflush (**Preflush=**) earlier, so that first measurement is made at **StartDateTime=**.

StartLater

Start logging at time set with delayed start date and time command, at rate defined by **SampleInterval**. Data is stored in FLASH memory. Data is transmitted real-time if **TxRealTime=Y**.

If you need to change HydroCAT-EP setup after **StartLater** has been sent (but before logging has started), send **Stop**, change setup as desired, and then send **StartLater** again.

Example: Program HydroCAT-EP to start logging on 20 September 2015 12:00:00 (user input in bold).

```
STARTDATETIME=09202015120000
STARTLATER
```

Note:

You may need to send **Stop** several times to get the HydroCAT-EP to respond. This is most likely to occur if sampling with a small **SampleInterval** and transmitting real-time data (**TxRealTime=Y**).

Stop

Stop logging (started with **StartNow** or **StartLater**) or stop waiting to start logging (if **StartLater** was sent but logging has not begun yet). Connect to HydroCAT-EP before entering **Stop**. **Stop** must be sent before uploading data from memory.

Polled Sampling Commands

These commands are used to request 1 or more samples from the HydroCAT-EP. Unless noted otherwise, the HydroCAT-EP does **not** store the data in FLASH memory.

Notes:

- See *Pump Operation* in *Section 2: Description of HydroCAT-EP* for details.
- Use **Preflush** and **PreflushStartTime=** commands to prime the pump upon deployment if you are planning to use polled sampling commands.
- Send Esc to cancel / stop any polled sampling command. This sets the error flag to 1 (sample aborted).

For polled sampling commands that run the pump (**TPS**, **TPSS**, **TPSN:x**, **TempCheck:x**), pump operation is dependent on the conductivity frequency from the last sample, and the setting for **MinCondFreq=**.

TS	Do not pump. Take sample, store data in buffer, output data.
TPS	Run pump, take sample, store data in buffer, output data.
TPSS	Run pump, take sample, store data in buffer and FLASH memory , output data. Note: HydroCAT-EP ignores TPSS if autonomous sampling (StartNow or StartLater has been sent).
TSN:x	Do not pump. Take x samples (1 – 100) and output data. To interrupt, press Esc key. Note: HydroCAT-EP ignores TSN:x if autonomous sampling (StartNow or StartLater has been sent).
TPSN:x	Run pump continuously while taking x samples (1 – 100) and outputting data. To interrupt, press Esc key. Note: HydroCAT-EP ignores TPSN:x if autonomous sampling (StartNow or StartLater has been sent).
SL	Output last sample stored in buffer.
TempCheck:x	Run pump continuously while taking x samples (1 – 100) and outputting data. Allows rapid sampling to perform temperature sensor verification; values for pH, oxygen, oxygen saturation, and HCO not valid. To interrupt, press Esc key. Note: HydroCAT-EP ignores TempCheck:x if autonomous sampling (StartNow or StartLater has been sent).
CondCheck:x	(do not run pump) Take x samples (1 – 100) and output data. Allows rapid sampling to perform conductivity sensor verification; values for pH, oxygen, oxygen saturation, and HCO not valid. To interrupt, press Esc key. Note: HydroCAT-EP ignores CondCheck:x if autonomous sampling (StartNow or StartLater has been sent).

Polled Sampling Commands (*continued*)

T63 **Do not pump.** Command SBE 63 to take 1 sample, and output oxygen data in format set by **SetFormat=** in *SBE 63*.

TOptics **Do not pump.** Command HCO to take 1 set of 30 measurements, output HCO data, and run wiper between each set of measurements. Output (comma separated):

- instrument serial number
- error flag (0 = good, 2 = did not take 30 HCO measurements, 4 = HCO wiper position error, 6 = flags 2 and 4)
- current draw by HCO wiper motor
- fluorescence counts at 3 different gain settings (1, 5, and 25)
- turbidity counts at 3 different gain settings (1, 5, and 25)

OpticsStats Output average and standard deviation results of previous **TOptics** command. Output (comma separated):

- instrument serial number
- fluorescence counts at 3 different gain settings (1, 5, and 25)
- turbidity counts at 3 different gain settings (1, 5, and 25)
- standard deviation of fluorescence counts at 3 different gain settings (1, 5, and 25)
- standard deviation of turbidity counts at 3 different gain settings (1, 5, and 25)
- date and time at the start of **TOptics** sampling
- error flag (0 = good, 2 = did not take 30 HCO measurements, 4 = HCO wiper position error, 6 = flags 2 and 4)

Data Upload Commands

Stop sampling (send **Stop**) before uploading data.

GetSamples:b,e Upload data from scan **b** to scan **e**, in format defined by **OutputFormat=**. First sample is number 1. As data is uploaded, screen first displays
 start sample number =
 start time =
 These are starting sample number and starting time for requested data. Maximum of 5000 samples can be uploaded at one time.

Example: Upload samples 1 to 200 to a file (user input in bold).
 (Click Capture menu and enter desired filename in dialog box)
GETSAMPLES : 1 , 200

Calibration Coefficients Commands

Calibration coefficients are initially factory-set and should agree with Calibration Certificates shipped with the HydroCAT-EP.

Notes:

- F = floating point number
- S = string with no spaces (maximum 10 characters)

*Temperature***TCalDate=S**

S=Temperature calibration date.

TA0=F

F=Temperature A0.

TA1=F

F=Temperature A1.

TA2=F

F=Temperature A2.

TA3=F

F=Temperature A3.

*Conductivity***CCalDate=S**

S=Conductivity calibration date.

CG=F

F=Conductivity G.

CH=F

F=Conductivity H.

CI=F

F=Conductivity I.

CJ=F

F=Conductivity J.

WBOTC=F

F=Conductivity wbotc.

CTCor=F

F=Conductivity ctcor.

CPCor=F

F=Conductivity pcpor.

CZ=F

F=Conductivity Zero Conductivity Frequency (Hz).

*Pressure***PCalDate=S**

S=Pressure calibration date.

PA0=F

F=Pressure A0.

PA1=F

F=Pressure A1.

PA2=F

F=Pressure A2.

PTCA0=F

F=Pressure ptca0.

PTCA1=F

F=Pressure ptca1.

PTCA2=F

F=Pressure ptca2.

PTCB0=F

F=Pressure ptcb0.

PTCB1=F

F=Pressure ptcb1.

PTCB2=F

F=Pressure ptcb2.

PTempA0=F

F=Pressure temperature a0.

PTempA1=F

F=Pressure temperature a1.

PTempA2=F

F=Pressure temperature a2.

POffset=F

F=Pressure offset (decibars).

Notes:

- Dissolved oxygen sensor coefficients are stored in the SBE 63, and are used to output converted oxygen data. To modify those coefficients, use **Send63:command** to send calibration coefficient commands to the SBE 63; see the SBE 63 manual for those commands.
- Fluorometer and turbidity sensor coefficients are stored in the HCO, and are used to output converted fluorometer and turbidity data.
- pH sensor slope, offset, and temperature are factory-set, and can be updated using the **pH Calibration** button in UCI.

Calculation of Oxygen Saturation

The HydroCAT-EP calculates and outputs Oxygen Saturation % if **OutputOxSat=y**. Oxygen Saturation % is the ratio of calculated oxygen to oxygen saturation, in percent:

$$\text{Oxygen Saturation \%} = (\text{Oxygen} / \text{Oxygen saturation}) * 100\%.$$

Oxygen is the oxygen value measured by the HydroCAT-EP, in ml/L.

Oxygen saturation is the theoretical saturation limit of the water at the local temperature and salinity value, but with local pressure reset to zero (1 atmosphere). This calculation represents what the local parcel of water could have absorbed from the atmosphere when it was last at the surface (p=0) but at the same (T,S) value. Oxygen saturation is calculated with the Garcia and Gordon equation–

Notes:

- The oxygen saturation equation based on work from Garcia and Gordon (1992) reduces error in the Weiss (1970) parameterization at cold temperatures.
- As implemented in the HydroCAT-EP, the Garcia and Gordon equation for oxygen saturation is valid for $-5 < \text{Temperature } ^\circ\text{C} < 50$ and $0 < \text{Salinity (psu)} < 60$. Outside of those ranges, the oxygen saturation, and corresponding oxygen saturation %, is not valid.

$$\text{Oxsol}(T,S) = \exp \{ A0 + A1(Ts) + A2(Ts)^2 + A3(Ts)^3 + A4(Ts)^4 + A5(Ts)^5 + S * [B0 + B1(Ts) + B2(Ts)^2 + B3(Ts)^3] + C0(S)^2 \}$$

where

- Oxsol(T,S) = oxygen saturation value (ml/L)
- S = salinity (psu)
- T = water temperature (ITS-90, °C)
- $Ts = \ln [(298.15 - T) / (273.15 + T)]$
- A0 = 2.00907 A1 = 3.22014 A2 = 4.0501
- A3 = 4.94457 A4 = - 0.256847 A5 = 3.88767
- B0 = -0.00624523 B1 = -0.00737614
- B2 = -0.010341 B3 = -0.00817083
- C0 = -0.000000488682

Appendix IV: AF24173 Anti-Foulant Device

AF24173 Anti-Foulant Devices supplied for user replacement are supplied in polyethylene bags displaying the following label:

AF24173 ANTI-FOULANT DEVICE

FOR USE ONLY IN SEA-BIRD ELECTRONICS' CONDUCTIVITY SENSORS TO CONTROL THE GROWTH OF AQUATIC ORGANISMS WITHIN ELECTRONIC CONDUCTIVITY SENSORS.

ACTIVE INGREDIENT:

Bis(tributyltin) oxide.....	53.0%
OTHER INGREDIENTS:	<u>47.0%</u>
Total.....	100.0%

DANGER

See the complete label within the Conductivity Instrument Manual for Additional Precautionary Statements and Information on the Handling, Storage, and Disposal of this Product.

Net Contents: Two anti-foulant devices

Sea-Bird Electronics, Inc.
13431 NE 20th Street
Bellevue, WA 98005

EPA Registration No. 74489-1
EPA Establishment No. 74489-WA-1

AF24173 Anti-Foulant Device

FOR USE ONLY IN SEA-BIRD ELECTRONICS' CONDUCTIVITY SENSORS TO CONTROL THE GROWTH OF AQUATIC ORGANISMS WITHIN ELECTRONIC CONDUCTIVITY SENSORS.

ACTIVE INGREDIENT:

Bis(tributyltin) oxide.....	53.0%
OTHER INGREDIENTS:	47.0%
Total.....	100.0%

DANGER

See Precautionary Statements for additional information.

FIRST AID	
If on skin or clothing	<ul style="list-style-type: none"> • Take off contaminated clothing. • Rinse skin immediately with plenty of water for 15-20 minutes. • Call a poison control center or doctor for treatment advice.
If swallowed	<ul style="list-style-type: none"> • Call poison control center or doctor immediately for treatment advice. • Have person drink several glasses of water. • Do not induce vomiting. • Do not give anything by mouth to an unconscious person.
If in eyes	<ul style="list-style-type: none"> • Hold eye open and rinse slowly and gently with water for 15-20 minutes. • Remove contact lenses, if present, after the first 5 minutes, then continue rinsing eye. • Call a poison control center or doctor for treatment advice.
HOT LINE NUMBER	
Note to Physician	Probable mucosal damage may contraindicate the use of gastric lavage.
Have the product container or label with you when calling a poison control center or doctor, or going for treatment. For further information call National Pesticide Telecommunications Network (NPTN) at 1-800-858-7378.	

Net Contents: Two anti-foulant devices

Sea-Bird Electronics, Inc.
 13431 NE 20th Street
 Bellevue, WA 98005

EPA Registration No. 74489-1
 EPA Establishment No. 74489-WA-1

PRECAUTIONARY STATEMENTS

HAZARD TO HUMANS AND DOMESTIC ANIMALS

DANGER

Corrosive - Causes irreversible eye damage and skin burns. Harmful if swallowed. Harmful if absorbed through the skin or inhaled. Prolonged or frequently repeated contact may cause allergic reactions in some individuals. Wash thoroughly with soap and water after handling.

PERSONAL PROTECTIVE EQUIPMENT

USER SAFETY RECOMMENDATIONS

Users should:

- Remove clothing immediately if pesticide gets inside. Then wash thoroughly and put on clean clothing.
- Wear protective gloves (rubber or latex), goggles or other eye protection, and clothing to minimize contact.
- Follow manufacturer's instructions for cleaning and maintaining PPE. If no such instructions for washables, use detergent and hot water. Keep and wash PPE separately from other laundry.
- Wash hands with soap and water before eating, drinking, chewing gum, using tobacco or using the toilet.

ENVIRONMENTAL HAZARDS

Do not discharge effluent containing this product into lakes, streams, ponds, estuaries, oceans, or other waters unless in accordance with the requirements of a National Pollutant Discharge Elimination System (NPDES) permit and the permitting authority has been notified in writing prior to discharge. Do not discharge effluent containing this product to sewer systems without previously notifying the local sewage treatment plant authority. For guidance contact your State Water Board or Regional Office of EPA. This material is toxic to fish. Do not contaminate water when cleaning equipment or disposing of equipment washwaters.

PHYSICAL OR CHEMICAL HAZARDS

Do not use or store near heat or open flame. Avoid contact with acids and oxidizers.

DIRECTIONS FOR USE

It is a violation of Federal Law to use this product in a manner inconsistent with its labeling. For use only in Sea-Bird Electronics' conductivity sensors. Read installation instructions in the applicable Conductivity Instrument Manual.

STORAGE AND DISPOSAL

PESTICIDE STORAGE: Store in original container in a cool, dry place. Prevent exposure to heat or flame. Do not store near acids or oxidizers. Keep container tightly closed.

PESTICIDE SPILL PROCEDURE: In case of a spill, absorb spills with absorbent material. Put saturated absorbent material to a labeled container for treatment or disposal.

PESTICIDE DISPOSAL: Pesticide that cannot be used according to label instructions must be disposed of according to Federal or approved State procedures under Subtitle C of the Resource Conservation and Recovery Act.

CONTAINER HANDLING: Nonrefillable container. Do not reuse this container for any other purpose. Offer for recycling, if available.

Appendix V: Sources of Variability in HCO Calibration Check

The HCO Check Cap (HCC) is a simple and convenient tool for monitoring the calibration status of your HCO (chlorophyll and turbidity sensor). To get the most accurate results, it is important to understand how the HCC interacts with the HCO.

Temperature has the greatest influence on accuracy of the readings. The HCO and HCC are tested together, and calibration check values are determined at 22 °C in our lab. Many components in this system are affected by temperature, but each channel has a dominant factor.

The fluorometer (chlorophyll) channel is primarily affected by the temperature of the target inside the HCC. The target's fluorescent quantum efficiency varies inversely with temperature, at a rate of approximately 2%/°C. This means that a 17 °C HCC (5 °C colder than the calibration temperature) returns a chlorophyll value approximately 10% higher than the check value determined in the lab.

The turbidity (NTU) channel is primarily affected by the temperature of the red LED. The red LED's output varies inversely with temperature, with roughly a 1%/°C increase in output for temperature below the calibration temperature.

The temperature effects were determined by performing two tests:

- The first test controlled the temperature of the HCO and HCC together in an environmental chamber. This test shows output from both channels changing with temperature, with the fluorometer channel changing more rapidly than the turbidity channel.

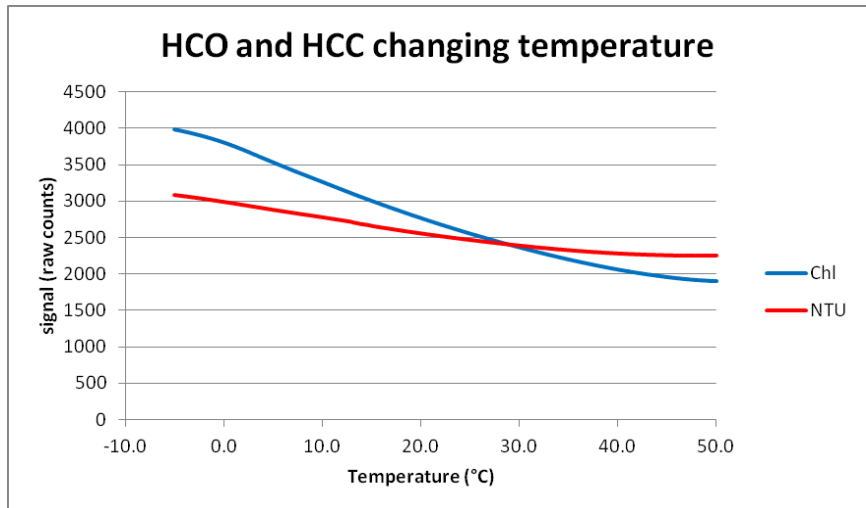

- The second test held the HCO at room temperature in the lab (22 °C), while changing the HCC temperature. This test shows the output from the turbidity channel is relatively unaffected by HCC temperature, while the output from the fluorometer channel registers a strong, linear correlation with temperature.

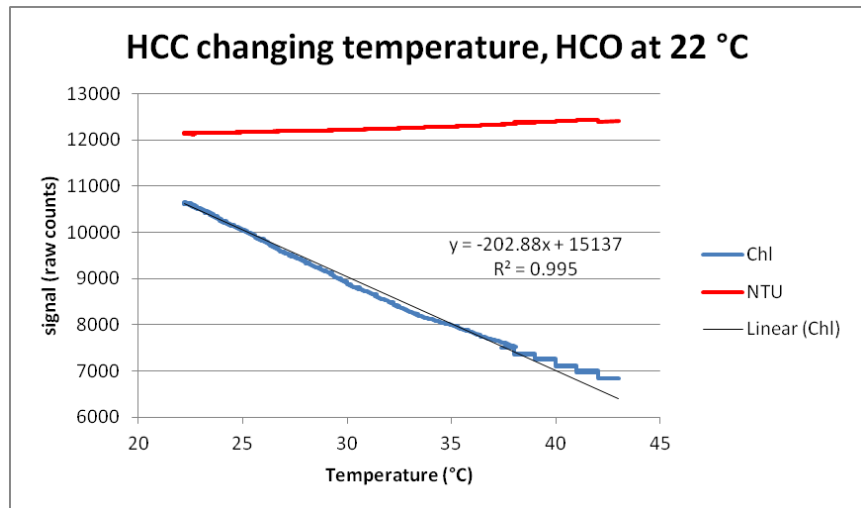

Because users cannot control field temperatures, we have limited the recommended temperature range at which the HCC check cap should be used and widened the acceptance criteria for the calibration check to allow for variability in the check cap response due to temperature.

- As described in *HCO (Fluorometer and Turbidity) Calibration Check* in *Section 5: Routine Maintenance and Calibration*, **the HydroCAT-EP and HCC must be between 18 and 26 °C for the calibration check to be valid. Allow at least 1 hour for the HydroCAT-EP and HCC to equilibrate before proceeding**

Appendix VI: Replacement Parts

Part Number	Part	Application Description	Quantity in HydroCAT-EP
50441	AA Saft Lithium cell set (12)	Power HydroCAT-EP	1
801863	Cell holder for HydroCAT-EP	Holds AA cells	1
801542	AF24173 Anti-Foulant Device	Bis(tributyltin) oxide device inserted into anti-foulant device cup	1 (set of 2)
30411	Triton X-100	Octyl Phenol Ethoxylate – Reagent grade non-ionic cleaning solution for conductivity cell (supplied in 100% strength; dilute as directed)	1
802220	6-pin MCIL-6FS (wet-pluggable connector) to 9-pin DB-9S I/O cable with power leads and leads to SDI-12, 2.4 m (8 ft) long	From HydroCAT-EP to computer and/or SDI-12 controller	1
171192	Locking sleeve (wet-pluggable connector)	Locks cable/plug in place	1
171498.1	6-pin MCDC-6-F dummy plug with locking sleeve, wet-pluggable connector	For when cable not used	1
171888	25-pin DB-25S to 9-pin DB-9P cable adapter	For use with computer with DB-25 connector	-
50640	Syringe kit	Kit (supplied) for flushing conductivity cell, oxygen sensor, pH sensor, and all plumbing: <ul style="list-style-type: none"> • 30385 Tygon tube ¼ “ ID • 30521 Syringe • 30579 Tygon tube, 3/8” ID • 311244 Female Luer thread to ¼” ID tubing barb • 31696 Reducing union 	1
Hach part number 013410HY	pH reference junction kit	Kit (supplied) for refilling pH reference junction: <ul style="list-style-type: none"> • Spare O-ring for Teflon junction • Spare Teflon junction • Syringe • Flat blade screwdriver • KCL salt pellets • 100 ml reference solution, saturated KCl and AgCl 	1

60074	Spare hardware / O-ring kit for HydroCAT-EP	<p>Assorted hardware and O-rings:</p> <ul style="list-style-type: none"> • 30097, O-ring, NAS1611-111A EP (2-111) (exhaust to cell guard seal) • 30174, Machine screw, 10-24 x 9/16 PH, SS (anti-foulant cover retaining screw) • 30498, O-ring, Parker, 2-110 N674-70 (anti-foulant cartridge seal) • 30857, O-ring, NAS1611-033A EP (2-033) (connector end cap O-rings) • 30858, O-ring, Parker 2-133 N674-70 (battery pack end cap O-rings) • 31322, O-ring, Parker 2-130 N674-70 (battery pack housing O-rings) • 31478, Washer shoulder, #8, Small parts B-WNS-8 (anti-foulant cover retaining screw insulator) • 31513, Cap screw, 8-32 x 5/8" SH, Titanium (secures sensor lift eye) • 31516, Hex key, 9/64" Long arm, DOALL #AHT58010 (tool for opening connector end cap) • 31670, Hex key, 3/32" Long arm, #7122A42 (tool for servicing pH module) • 31671, Hex key, 5/32" Long arm, #7122A46 (tool for removing copper anti-foulant assembly) • 31749, Hex key, 7/64" Long arm (tool for battery pack) • 31755, Cap screw, 8-32 x 1/4" SH, Titanium (secures connector end cap to housing) • 31811, Machine screw, 10-24 x 7/8, FH Phillips Titanium (anti-foulant cover retaining screw) • 30844, Screw, 10-32 x 3/8" FH Phillips, Titanium (cell guard) • 311521, Removable shipping sticker (keeps dirt out of conductivity cell) 	-
550616	Bail mounting kit	Parts for optional bail	-

Appendix VII: Manual Revision History

Manual Version	Date	Description
001	03/16	<ul style="list-style-type: none">• Initial release.
002	04/16	<ul style="list-style-type: none">• Add information on replacing cell guard O-ring if you remove conductivity cell guard.• Add information to Section 5 on performing Temperature Check in UCI.• Update dissolved oxygen specifications.• Add pHCalHist command.
003	01/17	<ul style="list-style-type: none">• Add more information/update information on use of 50640 reference check kit.• Add information that mounting bail is optional.• Switch to Sea-Bird Scientific cover; remove information on Sea-Bird Coastal.• Change name of Hydro-DO to SBE 63.

Index

A

- Air in plumbing · 18
- Anti-Foulant Device · 104
 - removal before shipping to Sea-Bird · 61
 - replacing · 50, 51
- Autonomous sampling · 29, 99

B

- Batteries · 14
- Battery endurance · 13
- Battery pack · 42
 - description · 23
 - endurance · 20
 - installing · 23
 - replacing · 49
 - shipping precautions · 11
- Baud rate · 30, 91
- Bleed hole · 41

C

- Cable length · 30
- Cables · 17
- Calibration · 61, 71
- Calibration coefficients · 102
- CE certification · 3
- Cells
 - replacing · 49
- Check cap
 - maintenance · 55
- Chlorophyll · 71
- Cleaning · 46, 52, 54, 55, 60
- Clock · 14, 70
- Command details · 75
- Command summary · 75
- Commands
 - autonomous sampling · 99
 - baud rate · 91
 - calibration coefficients · 102
 - coefficients · 102
 - data format · 97
 - data upload · 101
 - date and time · 91
 - descriptions · 30, 31
 - Fluorometer sensor setup · 96
 - general setup · 91
 - HCO sensor setup · 96
 - logging · 99
 - memory setup · 96
 - optical dissolved oxygen sensor setup · 95
 - Optics sensor setup · 96
 - polled sampling · 100
 - pump setup · 93
 - RS-232 setup · 92
 - SBE 63 setup · 95
 - SDI-12 · 31
 - SDI-12 setup · 92
 - status · 80
 - Turbidity sensor setup · 96

- Conductivity cell
 - maintenance · 52
- Conductivity sensor · 70
 - calibration · 61
- Connector · 16, 47
- Corrosion precautions · 46

D

- Data format · 34, 36, 97
- Data upload · 45
- Date and time · 91
- Declaration of Conformity · 3
- Deployment · 41
 - installation · 43
 - preparing for · 23
 - setup · 42
- Deployment orientation · 13, 16, 43
- Description · 12
- Dimensions · 16
- Dissolved oxygen sensor
 - calibration · 61
 - maintenance · 52
- Dissolved Oxygen sensor · 70

E

- Electronics disassembly/reassembly · 72
- End cap · 47
- End cap connector · 16
- External power · *See* Power, external

F

- Flooded HydroCAT-EP · 44
- Fluorometer · 70
 - calibration · 65, 108
- Format
 - data · 34, 36
- Functional description · 70

G

- Glossary · 69
- Guard
 - removal · 50, 51

H

- HCC
 - maintenance · 55
- HCO · 70, 71
 - calibration · 65, 108
 - maintenance · 55
- Housing
 - handling · 48

I

- Initializing memory · 96

L

Limited liability statement · 2
 Logging · 29, 99

M

Maintenance · 46
 Manual revision history · 112
 Memory · 14
 Memory setup · 96
 Minimum conductivity frequency · 18, 93
 Modes · *See* Sampling modes
 Mounting · 41

N

NTU · 71

O

Optics
 calibration · 65, 108
 maintenance · 55
 Orientation · 41
 O-ring
 maintenance · 49
 Output format · 36, 97
 Oxygen sensor · 70
 calibration · 61
 maintenance · 52

P

Parker Super O-Lube · 69
 Parts
 replacement · 110
 pH sensor · 70
 calibration · 63
 maintenance · 58
 replace · 58
 Polled sampling · 28
 Power
 endurance · 13
 external · 14, 21
 Pre-flush · 18
 Pressure sensor · 70
 calibration · 62
 maintenance · 54
 Prime pump · 18
 Pump · 13, 14, 16, 18, 27, 41, 43, 100
 maintenance · 60
 Pump setup commands · 93

Q

Quick start · 8

R

Real-time setup
 baud rate · 30
 cable length · 30
 Recovery · 44
 uploading data · 45
 Replacement parts · 110

Revision history · 112
 RS-232 output format · 36
 RS-232 setup commands · 92

S

Sample timing · 19
 Sampling modes · 27
 autonomous · 29
 logging · 29
 polled · 28
 SDI-12
 commands · 31
 data format · 34
 SDI-12 setup commands · 92
 Seasoft · 13
 Sediment · 60
 Sensors · 14
 Setup commands · 91
 Shipping precautions · 11
 Software · 13, 25
 Specifications · 14
 Status commands · 80
 Storage · 52, 55, 58
 Super O-Lube · 69
 System description · 12

T

Temperature
 maintenance · 54
 Temperature sensor
 calibration · 61
 Terminal program · 13, 25
 Test · 26
 Testing · 25
 Thermistor · 70
 Timeout description · 30
 Transient current · 21
 Triton · 69
 Troubleshooting · 66
 Turbidity · 71
 Turbidity sensor · 70
 calibration · 65, 108

U

UCI · 13, 25, 26, 45
 Universal Coastal Interface · 25
 Unpacking HydroCAT-EP · 10
 Uploading data · 45
 USB driver · 25

V

Versions · 112

W

Wiper
 maintenance · 55
 Wiring · 17, 25

Z

Zero conductivity frequency · 18