

# Brief instructions

## Acoustic, digital current meter OTT ADC

### Handheld unit

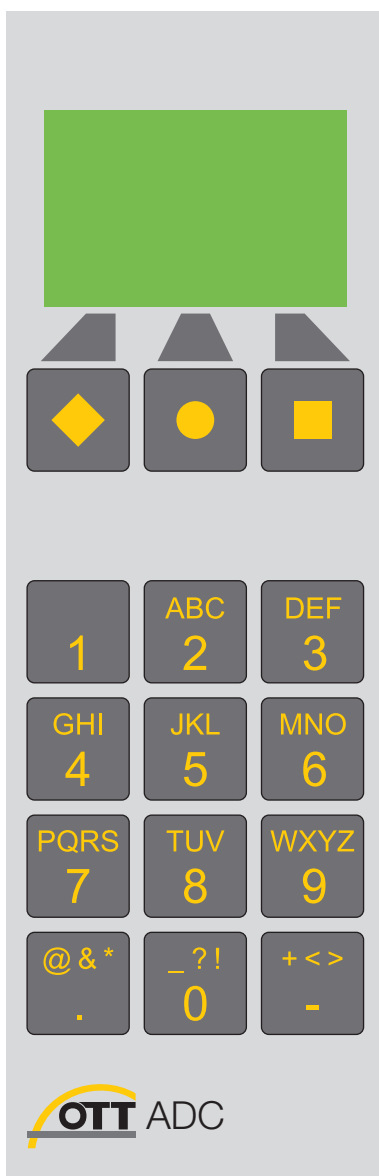





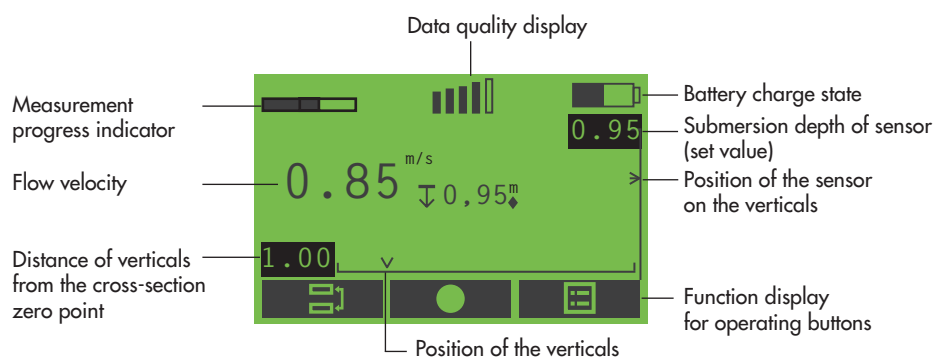







### Display screens

The following graphic shows an example of the display screen during a measurement.













### Display symbols

	Battery charging state
	Data quality display
	Water temperature
	Battery power supply
	Distance of verticals from cross-section zero point
	Position of vertical
	Position of sensor on the vertical (actual value)
	Position of sensor on the vertical (set value)
	Flow velocity
	Depth of the sensor (actual value)
	Note: Leave sensor at current position (depth)
	Note: Position sensor further up/down
	Measurement progress indicator

### Operating buttons

The function of each operating button (◆, ●, ■) is dependent on the current operational situation. It is shown directly above the respective key in the display.

	Move up/down (in multipart menus and lists)
	Ok and continue
	Delete
	Call main menu
	Switch between two views on a display
	Return to previous menu
	Delete character (in entry masks)
	Confirm entry (in entry masks)
	Call help
	Starting measurement

### Charging batteries

- Connect the power supply/charger to the handheld unit via the USB connection.
- Connect the plug of the power supply/charger to the electrical supply. The rechargeable batteries are charged. The charging process is complete when the battery symbol in the upper right corner of the display is full.

### Starting up the ADC

- Install the handheld unit on the OTT Heres or rod.
- Install the sensor on the OTT Heres or rod.
- Connect the sensor connection cable to the handheld unit. Take care to note the red markings on the plug and socket!
- Switch on handheld unit (press on/off switch for approx. 1 second).

## Entering characters

Characters are entered via the keyboard of the handheld unit. Depending on the operational situation, the entry of numbers or text is possible in the individual entry mask.

- Numbers, ". "and "-": press relevant key once.
- Text: press relevant key 1x, 2x, 3x or 4x until the required character is shown in the display.

## Example: input mask



- Delete character: press **◆** key.
- Confirm entry: press **■** key.

## Overview of main menu

- Call main menu: Press **■** key (after switching on the handheld unit and, dependent on the current operational situation, within submenus).

- Call submenu: press the relevant number for the respective submenu.

### Main Menu Part 1

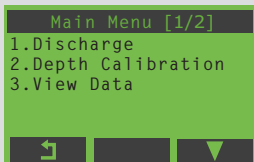

1. 1. Setting parameters for discharge measuring.  
 2. Name:\*\*\*  
 3. Party:  
 4. Notes  
 5. START

2. Enter file name.
3. Enter name for party.
4. Enter notes.
5. Start measurement.

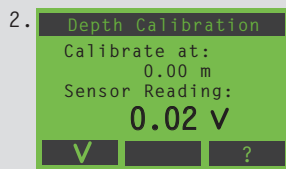

2. Calibrating the sensor for depth measurement.

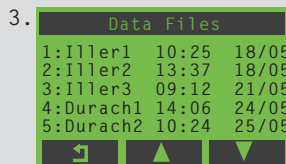

3. Call information on saved file.

### Main Menu Part 2

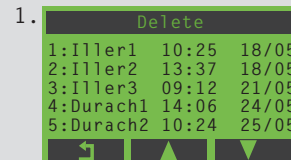
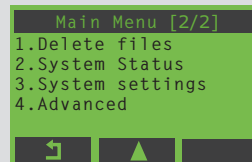

1. Deleting saved file.

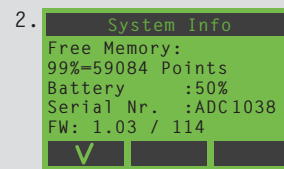

2. System Info

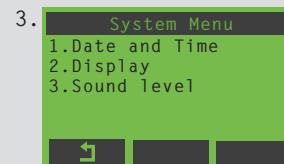

3.
  1. Enter hours, minutes, seconds and year (2-digit).
  2. Set display and frequency of the measured value display.
  3. Set volume.

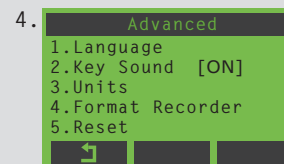

4.
  1. Select display language.
  2. Switch key sounds on/off
  3. Select units (metric/imperial).
  4. Delete memory.
  5. Carry out a reset (all settings are reset.)

## Example: Discharge measuring – step by step

### Step 1: depth calibration

Requirements: the sensor is outside of the water.

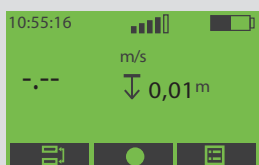

- Call main menu: press **■** key.

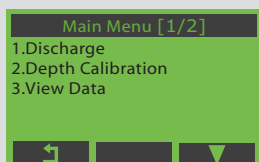

- Press key 2.

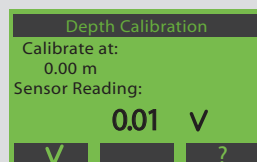

- Position sensor at calibration depth.
- Press **◆** key to start the calibration.

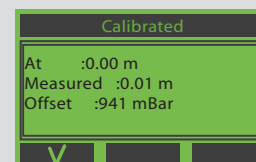

- Press **◆** key.

## Step 2: Making basic settings to the discharge measurement

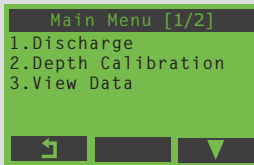

- Press key 1.

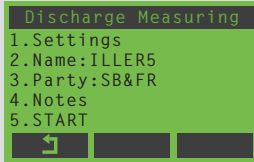

- Press key 2 and enter file name (max. 8 characters, no spaces or special symbols).
- Press key 3 and enter party.
- Press key 4 and add notes if wanted.
- Press key 1 → Discharge menu [1/3] opens.

### 2a: There are not yet any basic settings at the station



- Press key 2, 3, 4 or 5 and set the respective parameters (see below).
- Press key → next menu level.
- Press key → Return to Discharge measuring menu.

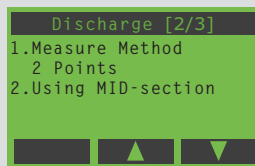

- Press key 1 and select the measure method.
- Press key 2 and select the type of evaluation.
- Press key → next menu level.

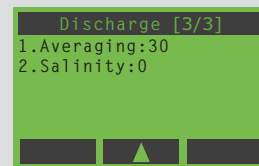

- Press key 1 and change the measuring time if necessary.
- Press key 2 and change the salinity if necessary.

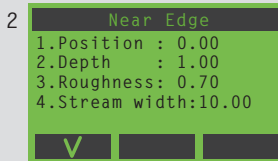

- Press key 1 and enter position. Reference point = near edge → set to 0. Reference point ≠ near edge → set position > 0 (distance of the near edge from the cross-section zero point).
- Press key 2 and enter depth. Rectangular cross-section → set depth > 0. Natural rivers → set to 0.
- Press key 3 and enter roughness of the side wall (relevant with rectangular cross-section).
- Press key 4 and enter stream width.

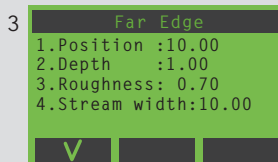

- Press key 1 and enter position. Set position > 0 (distance of far edge from zero point of cross-section).
- Press key 2 and enter depth. Rectangular cross-section → set depth > 0. Natural rivers → set to 0.
- Press key 3 and enter roughness of the side wall (relevant with rectangular cross-section).
- Press key 4 and enter stream width.

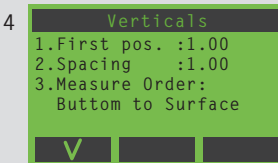

- Press key 1 and enter position of the first vertical.
- Press key 2 and enter the spacing of the verticals.
- Press key 3 and select the order of measurement: "Surface to Bottom"; "Bottom to Surface" or "Alternating".

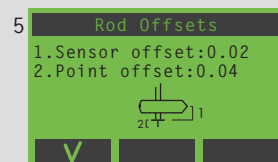

- Press key 1 and enter sensor offset (distance of the symmetry axis of the sensor to the base plate of the measuring rod).
- Press key 2 and enter point offset. (distance of base plate of the measuring rod to the bed of the waterway).

### 2b: There are already basic settings at the station

Press key 1 in the Discharge Measuring menu (see above).

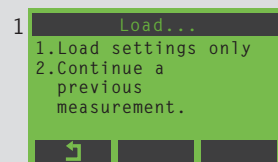

- Press key 1 or 2.

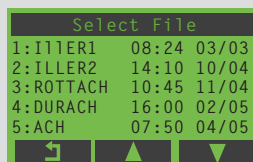

- Select file with its basic settings.

- If point 1 in the Load... menu has been selected:
  - Press key → return to Discharge Measuring menu.
- If point 2 in the Load... menu has been selected:
  - Press key 3 times → change to the measuring mode; Continue measurement with another measuring point.

### Step 3: Carry out discharge measurement

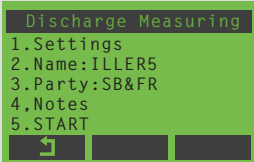

- Press key 5.
- Enter file name in subsequent window if necessary.
- Confirm: Press **Y** key.

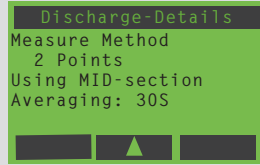
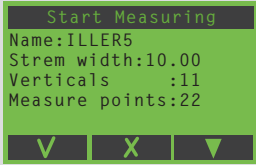

- Show details: Press **Y** key.
- Starting measurement: Press **ENTER** key.

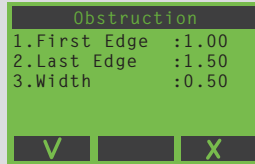
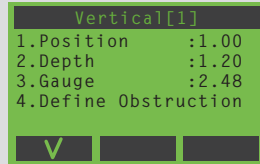
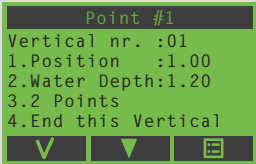

- Lower sensor to bottom.
- Press key 2.
- Confirm water depth: Press **ENTER** key.
- If required, call verticals information: Press **ENTER** key.
- Enter level if required: press key 3.
- Enter parameters for obstruction if necessary: press key 4.
- Continue: Press **ENTER** key.

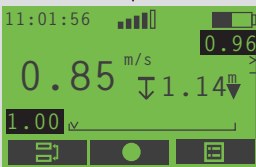

- Position sensor at preset depth (in example 0.96). The symbol for the preset depth (set submersion depth) blinks until the sensor position is correct.
- Starting measurement: Press **ENTER** key.

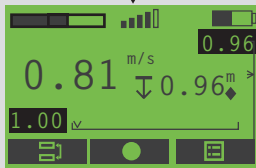

Measurement runs for the set time interval.

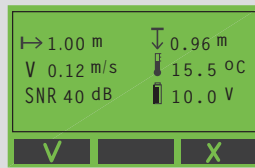

- Accept measurement results: Press **ENTER** key.
  - Continue with measure point 2 as described above.
- or
- Reject measurement: Press **Y** key.
  - Repeat measurement.

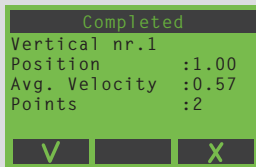

- Vertical 1 is finished.
- Continue: Press **ENTER** key.

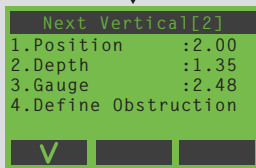

- Continue with vertical 2.

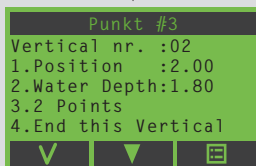

- Continue with measure point 3 as described above.
- Continue until all verticals have been processed.

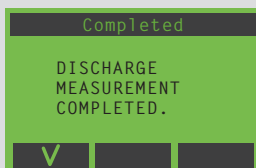

- All verticals have been completed.
- Continue: Press **ENTER** key.

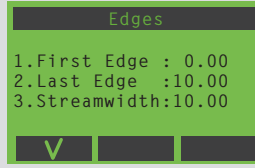

- Adjust edge parameters as necessary.
- Continue: Press **ENTER** key.

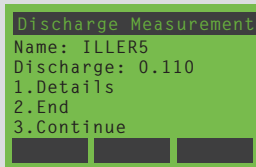

- Display additional information: press key 1.
- End measurement: Press key 2 and confirm the query with **ENTER** key in the subsequent window.

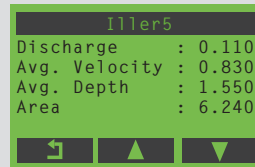

- Display details for the individual verticals: Press **Y** key.

## Maintenance Work

Before packing the devices, remove any dirt and dry the probe and rods with a cloth.

## Transferring data to the PC

To give a clear representation of your data on a PC and for subsequent analysis, the OTT QReview software is supplied. Using OTT QReview, you can transfer your measured data directly from the handheld unit to a PC.

### Transferring data

Requirements:

- ▶ OTT QReview (*QReview.exe*) software is installed on the PC
- ▶ USB driver of the handheld unit (*CDM\_Setup\_USBdrivers.exe*) is installed on the PC

Procedure:

- Connect the PC to the handheld unit via the USB connection using the USB cable supplied.
- Switch on the handheld unit.
- Start the OTT QReview software (double-click on *QReview.exe*).
- Select *ADC* tab and click on *Connect*.
  - If necessary, check which COM port is used by the USB interface where the handheld unit is connected. You will find the COM port in the Device Manager of the operating system, e.g. in Windows XP under *Settings/Control Panel/System/Hardware/Device Manager/Ports (COM and LTP)/USB serial port*.
  - In the subsequent window, select the relevant COM port from the drop-down menu and click on *Connect*.

The files are displayed in the the area *Files on ADC* in the *Connect* window. To save the files on the PC, proceed as described below:

- Highlight the files required.
- Under *Files on desktop*, select a directory where the files are to be stored.
- Click on the *Retrieve files* button.

Further notes on the process can be found in the OTT QReview online help.

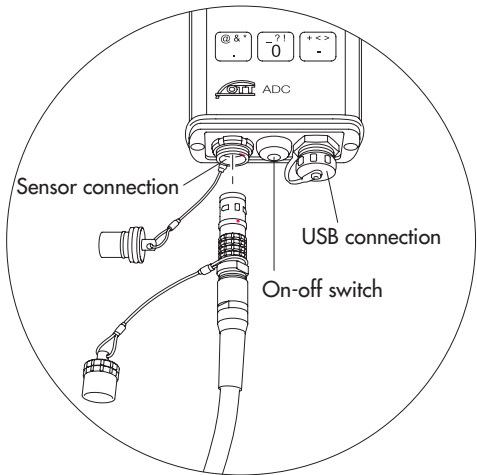

Handheld unit

Installation of the controller on the measuring rod

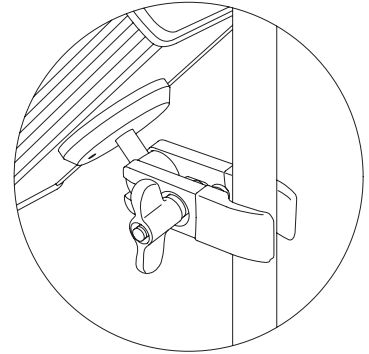

OTT Heres adjuster

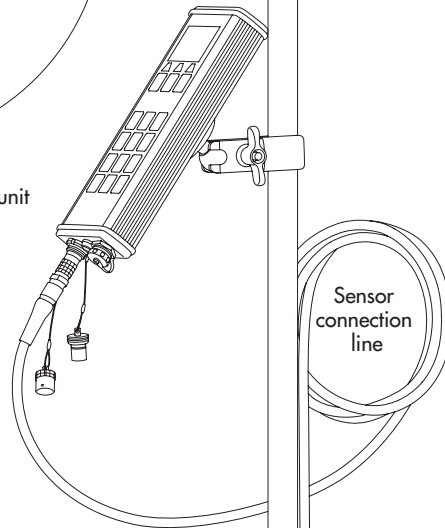

Installation directly onto rod (Ø 20 mm)

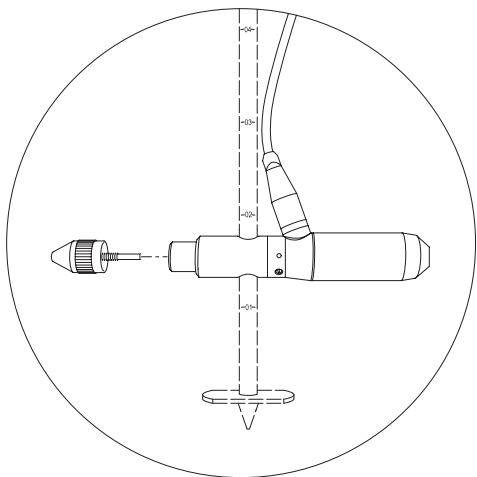

Installation in combination with OTT Heres adjuster

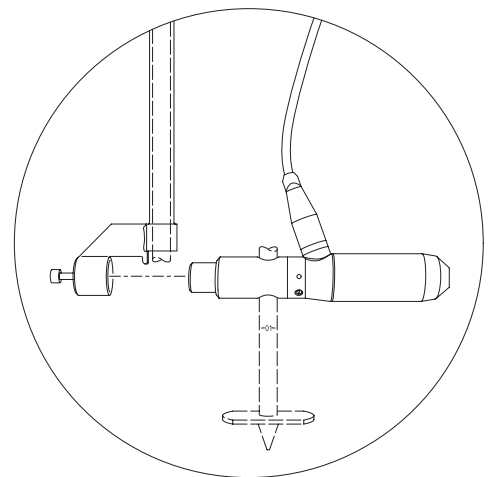

Sensor

Rod (Ø 20 mm)

**OTT Hydromet GmbH**

Ludwigstrasse 16  
 87437 Kempten · Germany  
 Tel. +49 831 56 17-0  
 Fax +49 831 56 17-209  
 info@ott.com · www.ott.com