

Operating instructions  
**Contact gauge**  
**KL 010 TCM**

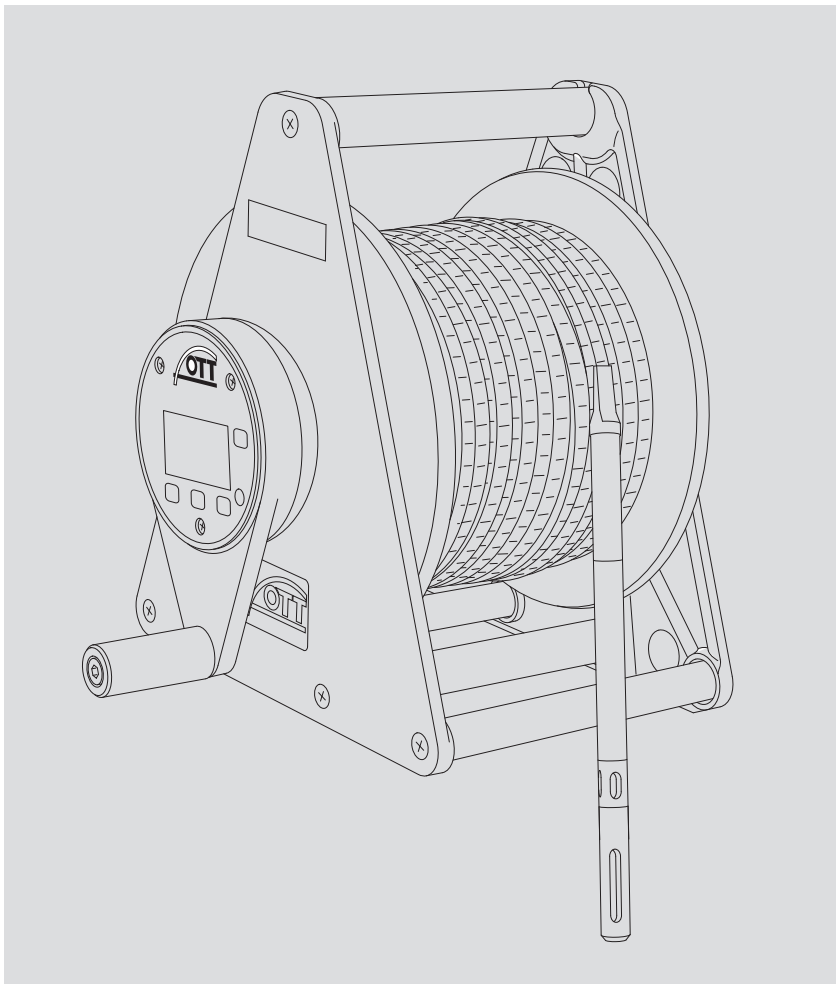

## **Table of contents**

<b>1 Scope of supply</b>	<b>3</b>
<b>2 Order numbers</b>	<b>3</b>
<b>3 Introduction</b>	<b>4</b>
<b>4 Starting up</b>	<b>4</b>
<b>5 Making basic settings</b>	<b>5</b>
<b>6 Carrying out the measurement</b>	<b>7</b>
<b>7 Changing batteries</b>	<b>8</b>
<b>8 Cleaning the contact gauge</b>	<b>9</b>
<b>9 Calibrating the conductivity measuring cell</b>	<b>9</b>
<b>10 Troubleshooting</b>	<b>10</b>
<b>11 Technical data</b>	<b>11</b>

## 1 Scope of supply

- ▶ **KL 010 TCM**
  - 1 contact gauge for measuring the water level, the water temperature and the electrical conductivity
  - 4 1.5 V batteries; type: LR 14 · C · AM 2
  - 1 set of operating instructions

## 2 Order numbers

- ▶ **KL 010 TCM**
  - Contact gauge**
    - 30 m measuring range (design 1) 24.322.030.9.5
    - 50 m measuring range (design 1) 24.322.050.9.5
    - 100 m measuring range (design 1) 24.322.100.9.5
    - 150 m measuring range (design 2) 24.322.150.9.5
    - 200 m measuring range (design 2) 24.322.200.9.5
    - 250 m measuring range (design 2) 24.322.250.9.5
    - 500 m measuring range (design 2) 24.322.500.9.5
- ▶ **Accessories**
  - Protective carrier - small** 24.110.040.4.5
    - for design 1; up to 100 m measuring tape length
    - in coated nylon
  - Protective carrier - large** 24.110.041.4.5
    - for design 2; from 150 m measuring tape length
    - in coated nylon
  - Calibration container** 55.445.025.9.2
    - for calibration of the conductivity measuring cell
- ▶ **Consumable materials**
  - Conductivity calibration solution** 55.495.352.9.5
    - 1.412 mS/cm
    - 1000 ml
  - Alkaline battery** 96.800.003.9.5
    - LR 14 · C · AM 2
    - 4 pieces required

### 3 Introduction

The KL 010 TCM contact gauge is used for fast and accurate determination of the water level in groundwater measurement stations. Furthermore, it also determines the temperature and the specific conductivity of the water body.

It is useful, for example, both for control measurements in observation wells or wellhead shafts (depth measurement), as well as for the continuous monitoring of pump tests. In the same way, it is possible to record temperature and conductivity profiles.

The contact gauge is equipped with a backlit LCD display, a signal LED and an acoustic signal generator.

The electrical conductivity is dependent on the temperature of the water. To make measurements comparable, the measured conductivity must be referred to a reference temperature via a temperature compensation. The KL 010 TCM offers various setting possibilities for this.

Furthermore, it is in the position to calculate a TDS value from the electrical conductivity and to show it on the LCD display. (TDS = Total Dissolved Solids; concentration of all the ions dissolved in the water; unit: ppm, parts per million).

Fig. 1: The KL 010 TCM contact gauge is available in two designs: design 1 up to 100 m measuring tape length; design 2 from 150 m measuring tape length.

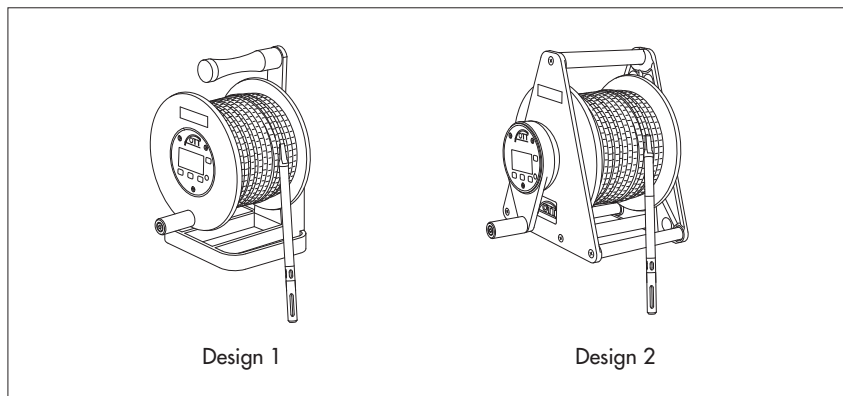

### 4 Starting up

OTT supplies the KL 010 TCM contact gauge ready to use with batteries inserted. Before initial startup, various basic settings must be checked and adapted to the individual circumstances on location as necessary:

- ▶ Type of temperature compensation for the conductivity measurement
- ▶ Display/remove the TDS value
- ▶ Language of the LCD display
- ▶ Sensitivity when recognizing the water surface

You can leave the batteries in the unit between measurements. However, you must switch off the contact gauge after use by pressing the  button (no automatic switching off)!

For extended storage, we recommend that the batteries are removed from the device (there is a danger of leakage even with high-quality batteries).

## 5 Making basic settings

### How to make the basic settings for the contact gauge:

















- Switch on the device: Press the  button.
- Call the Basic settings menu: Press the  button.
- Select the required menu point: Press the  button (several times) (return to top: press the  button).
- Enable menu point: press the  button.
- Select the required function: Press the  button (several times) (return to top: press the  button).
- Enable function: press the  button.
- Select the individual factor as required and set (TC + TDS):
  - Enable menu point "factor": press the  button → the first number blinks;
  - set the first number: press the   button;
  - select the next number: press the  button;
  - set the next number: press the   button;
  - set the other numbers as described above.
- Select menu point "back": press the  button (several times).
- Enable menu point "back": press the  button.
- Exit the Basic settings menu: repeat both previous steps.
- Switch off the device: press the  button.

Fig. 2: Structure of the Basic settings menu.

Enabling of a function identified with a \* ends the Basic settings menu.

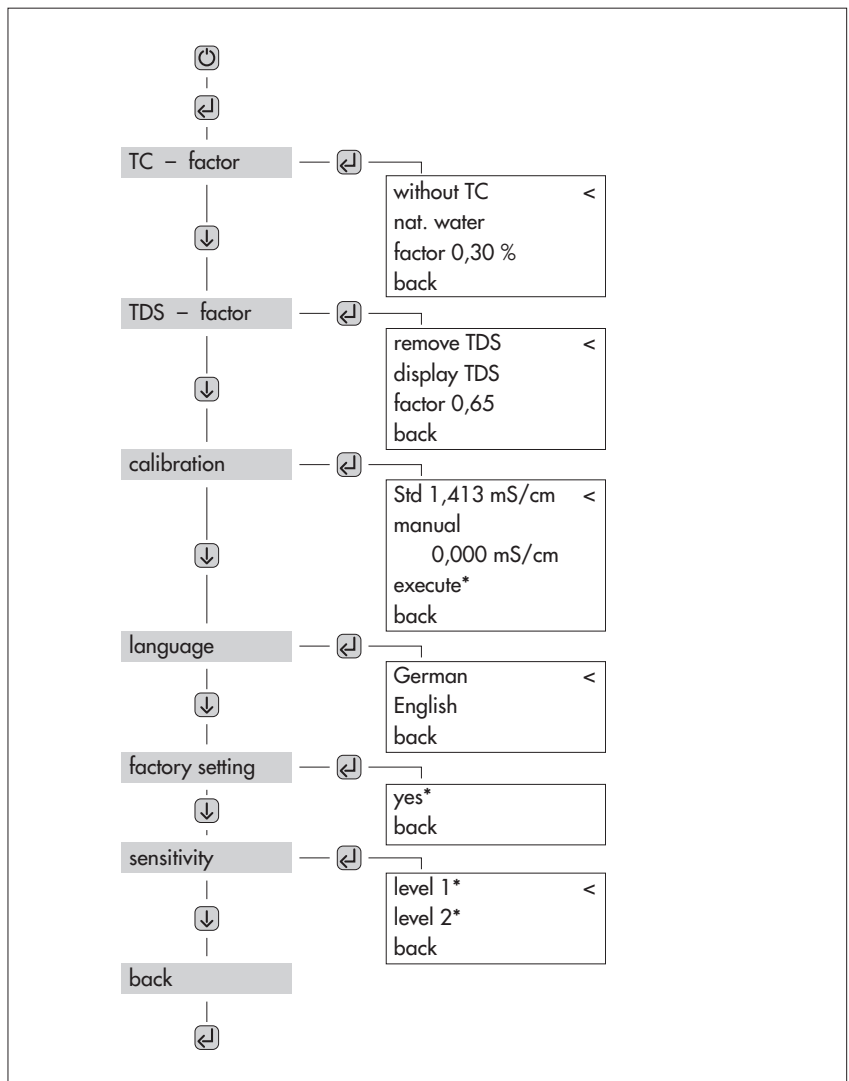

### **TC - factor**

- ▶ without TC  
The contact gauge displays the conductivity values measured without a temperature compensation. In this way, the conductivity values are referenced to the temperature measured at the same time in each case.
- ▶ nat. (natural) water  
The contact gauge automatically references the conductivity values measured in accordance with the DIN EN 27888 standard to a reference temperature of +25 °C.  
You can use this setting for measured values up to approx. 1.100 mS/cm (at +25 °C).
- ▶ factor ... %  
If you would like to measure a special solution, contaminated or strongly saline water, you have to individually determine the temperature coefficient.  
To do this, measure the conductivity of a solution at two different temperatures (for example at 15 °C and 25 °C) and determine the temperature coefficient using the deviation of the conductivity value in "%/°C".  
Factory setting: 0.30 %.

### **TDS - factor**

- ▶ remove TDS  
The contact gauge does not show the TDS value in the LCD display.
- ▶ display TDS  
The electric contact gauge calculates the TDS value from the conductivity measured and shows it in the LCD display. The calculation is made using the equation  $TDS [ppm] = 0.65 \times \text{electrical conductivity [mS/cm]}$ . This equation is valid for an influence on the measurement medium by sea water.
- ▶ factor ...  
For special applications, you can change the factor in the equation.  
Factory setting: 0.65.

### **Calibration**

See individual Chapter

### **Language**

Enabling a language immediately changes all texts in the LCD display to the selected language.

- ▶ German
- ▶ English

### **Factory setting**

Enabling this function calls the factory setting for the TC and TDS factors and restores the factory calibration.

- ▶ yes

### **Sensitivity**

The contact gauge recognizes the water surface by a change in conductivity. For this it is necessary to adapt the recognition sensitivity of the contact gauge to the conductivity of the measuring medium.

- ▶ level 1 (0 to approx. 6 mS/cm)
- ▶ level 2 (2 mS/cm to approx. 200 mS/cm)

## 6 Carrying out the measurement



### Safety information

- ▶ Only use the contact gauge for measurements in water or aqueous liquids (hydrometry)! Never use the contact gauge in combustible liquids!
- ▶ Avoid contaminating the groundwater when using a contact gauge!
- ▶ Do not kink the measuring tape! Danger of breakage!

### Carry out a measurement as follows:



- Switch on the device: press the  button.
- Unscrew the star grip bolt (transport retainer).
- Lower the measuring tape with the measuring probe by operating the hand crank, for example into the observation well → when the measuring probe touches the water surface, an acoustic signal sounds for approx. 10 seconds, the signal LED lights and the LCD display shows the temperature and conductivity values. Lowering the measuring probe further allows the temperature and conductivity profiles to be determined. Moving the measuring tape up and down a few centimeters allows the exact water level to be detected. The distance between reference level (e.g. upper edge of top cap) and the water surface is read off the measuring tape in meter and centimeter.
- Pull the measuring tape with measuring probe out of the observation well by operating the hand crank. (Clean the measuring tape and probe as necessary. See "Cleaning the contact gauge".)
- Place the measuring probe into the holder for storage.
- Tighten the star grip bolt.
- Switch off the device: press the  button.

Fig. 3: Application example of a depth measurement with the KL 010 TCM contact gauge.



**Please note:** Always measure the conductivity in the area of the observation well filter. An exchange of water with the surrounding aquifer is only ensured in this area and changes in the conductivity can be detected in good time.

## 7 Changing batteries

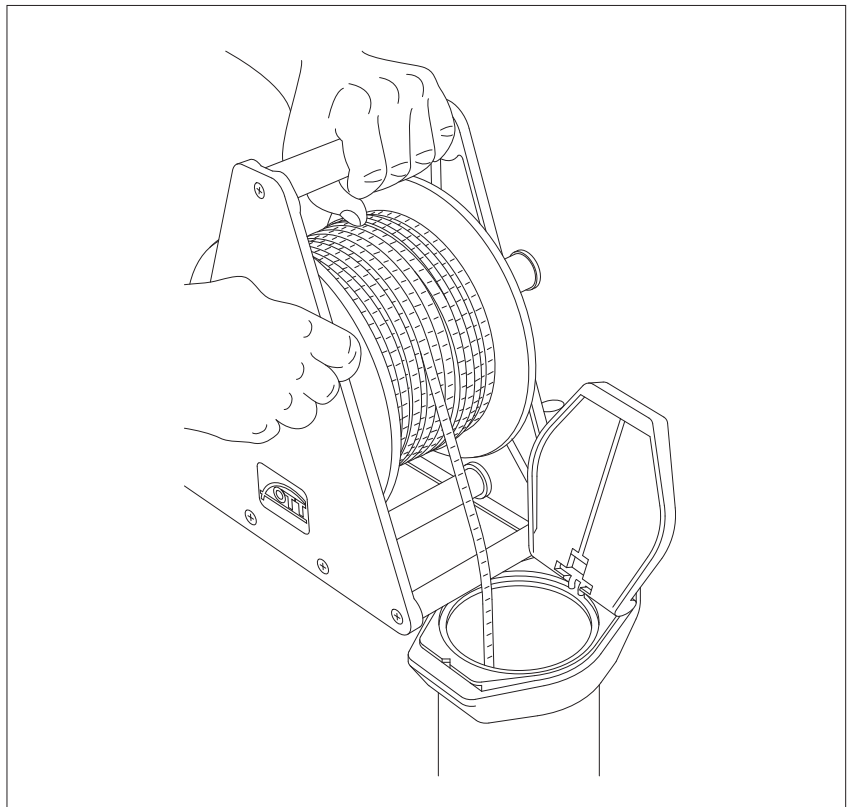



**Please note:** Dispose of used batteries properly! Never place batteries in the normal household waste!

### How to check the battery capacity:

- Switch on the device: press the  button → the LCD display shows the remaining battery capacity available in % (bar graph display). Recommendation: Replace the batteries when the battery capacity is  $\leq 10\%$ . For environmental temperatures below  $0\text{ }^{\circ}\text{C}$ , replace earlier.

### How to replace the batteries:

#### Design 1

- Switch off the device: press the  button.
- Unscrew both screw caps.
- Remove empty batteries.
- Ensure correct battery polarity!  
Insert two new 1.5 V batteries type LR 14 · C · AM 2 into the battery compartments. Each plus terminal must point towards the screw cap.
- Screw both screw caps back in → the device switches itself on.
- Switch off the device: press the  button.

#### Design 2 (see Fig. 4)



- Switch off the device: press the  button.
- Unscrew the screw cap.
- Remove empty batteries.
- Ensure correct battery polarity!  
Insert four new 1.5 V batteries type LR 14 · C · AM 2 into the battery compartment. Each plus terminal must point towards the screw cap.
- Screw the screw cap back in → the device switches itself on.
- Switch off the device: press the  button.

Fig. 4: Changing batteries (design 2).



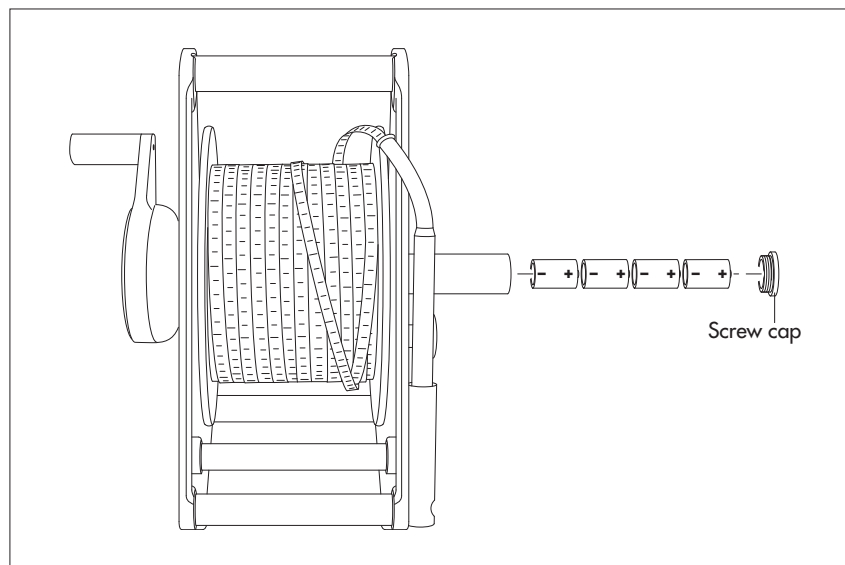

## 8 Cleaning the contact gauge

- Clean the measuring tape at regular intervals depending on how dirty it is by simply wiping with water or soap solution. Where necessary, you can also use a soft brush.
- Carefully clean the measuring probe with a brush and soapy water. In doing so, do not damage the conductivity measuring cell with sharp or metallic objects!
- You can likewise clean the frame and drum with water or soap solution. However, the frame must not under any circumstances be immersed in water!





After using the contact gauge in heavily contaminated or saline water (e.g. checking for seepage near a household waste site):

- Thoroughly rinse the measuring tape and the measuring probe with clear water!



## 9 Calibrating the conductivity measuring cell

The conductivity measuring cell of the KL 010 TCM is calibrated at the factory. Where necessary, you can calibrate the conductivity measuring cell with an individual (any conductivity value) or standard calibration solution (1.413 mS/cm).













### Calibrate the conductivity measuring cell as follows

- Switch on the device: press the  button.
- Put the calibration solution into the calibration container (accessory), filling height approx. 3/4.  
The calibration solution should be at the surrounding temperature.
- Place the measuring probe into the calibration container.
- Call the Basic settings menu: press the  button.
- Select menu point "calibration": press the  button twice.
- Enable menu point "calibration": press the  button.

### With standard calibration solution:

- Check whether menu point "Std 1.413 mS/cm" is selected (marked "<").
- Select menu point "execute": press the  button four times.
- Enable menu point "execute": press the  button → the conductivity measuring cell is re-calibrated and the Basic settings menu closed.

### With individual calibration solution:

- Select menu point "manual": press the  button twice.
- Enable menu point "manual": press the  button (marked "<").
- Select the line with the calibration value: press the  button.
- Start entering the calibration value: press the  button → the first number blinks.
- Set the first number: press the   buttons.
- Select the next number: press the  button.
- Set the next number: press the   buttons.
- Set the other numbers as described above.
- Select menu point "execute": press the  button.
- Enable menu point "execute": press the  button → the conductivity measuring cell is re-calibrated and the Basic settings menu closed.
- Take the measuring probe out of the calibration container, rinse with clear water, and dry.
- Switch off the device: press the  button.
- Dispose of the used calibration solution!

## 10 Troubleshooting

Test the contact gauge in a suitable container with clear tap water when troubleshooting.

- ▶ LCD display shows no values. No signal tone.  
Batteries are completely discharged → replace the batteries.
- ▶ The LCD display does not show the TDS value  
The TDS value is hidden → call the Basic settings menu and display the TDS value.
- ▶ The contact gauge does not recognize the water surface  
The sensitivity setting has been incorrectly selected → call the Basic settings menu and select the sensitivity appropriate to the local conditions.
- ▶ Conductivity value is not plausible  
Conductivity measuring cell is dirty → clean the complete measuring probe and then carry out a test measurement (e. g. in calibration solution). If deviations continue → re-calibrate the conductivity measuring cell.

For all other faults or damage to the contact gauge → have the contact gauge checked and repaired by the OTT Service Department.

## 11 Technical data

Measuring tape	
Type	2-strand; conductor in high strength, rust and acid resistant, stainless-steel wires
Material	White polyethylene
Markings	Meter scale: red; cm divisions (1 cm = narrow line, 5 cm = wide line) and dm numbers (10 cm): black
Measurement accuracy	0.1 % of measured value
Drum material	Special plastic, high strength, resistant to cold
Frame material	
Design 1	Cast aluminum, steel
Design 2	Special plastic, high strength, resistant to cold
Power supply	6 V DC; 4 batteries 1.5 V; type: LR 14 · C · AM 2; alkaline manganese; operating life: approx. 180 hours
Operating temperature range	-20 °C ... +75 °C
Recommended storage temperature	+5 °C ... +30 °C (best for the batteries)
Measuring range (measuring tape length)	25 m ... 500 m (8 levels)
Signaling	LCD display (3 line + bar graph display for battery state) + LED + acoustic signal generator
Temperature sensor	
Measuring range	-1 °C ... +70 °C
Measuring accuracy	± 0.1 °C
Conductivity measuring cell	
Measuring range	0 ... 200 mS/cm
Measuring accuracy	≤ ±0.5 % of measured value, at least ±2 mS/cm
Measuring probe	
Material	Stainless steel
Diameter	20 mm
Length	238 mm (incl. kinking protection 272 mm)
Protection class for measuring tape drum	IP 64
Weight	approx. 3.7 kg (30 m) ... approx. 14.5 kg (500 m)

We reserve the right to make technical changes  
and improvements without notice.

Document number  
24.322.000.B.E 01-0511

**OTT** Hydromet GmbH

Ludwigstrasse 16  
87437 Kempten · Germany

Tel. +49 831 5617-0

Fax +49 831 5617-209

[info@ott.com](mailto:info@ott.com) · [www.ott.com](http://www.ott.com)