



SEA-BIRD  
COASTAL

# HydroCAT Manual

Conductivity, Temperature, (optional) Pressure, and  
(optional) Optical Dissolved Oxygen Recorder with  
Integral Pump and SDI-12 and RS-232 Interface

Sea-Bird Coastal  
13431 NE 20<sup>th</sup> Street  
Bellevue, WA 98005

+1 425-401-7654

[support@sea-birdcoastal.com](mailto:support@sea-birdcoastal.com)

[www.sea-birdcoastal.com](http://www.sea-birdcoastal.com)



Manual Version 006, 05/01/15  
Firmware Version 2.13.0  
UCI Version 1.0.0 and later

# Limited Liability Statement

Extreme care should be exercised when using or servicing this equipment. It should be used or serviced only by personnel with knowledge of and training in the use and maintenance of oceanographic electronic equipment.

SEA-BIRD ELECTRONICS, INC. disclaims all product liability risks arising from the use or servicing of this system. SEA-BIRD ELECTRONICS, INC. has no way of controlling the use of this equipment or of choosing the personnel to operate it, and therefore cannot take steps to comply with laws pertaining to product liability, including laws which impose a duty to warn the user of any dangers involved in operating this equipment. Therefore, acceptance of this system by the customer shall be conclusively deemed to include a covenant by the customer to defend, indemnify, and hold SEA-BIRD ELECTRONICS, INC. harmless from all product liability claims arising from the use or servicing of this system.

# Declaration of Conformity

**Note:**

The HydroCAT is not listed on the Declaration of Conformity. However, it contains the same electronics as the SBE 37-SMP, so is CE certified by extension.

**Sea-Bird Electronics, Inc.**  
13431 NE 20<sup>th</sup> Street, Bellevue, WA 98005 USA

## DECLARATION OF CONFORMITY

**Manufacturer's Name:** Sea-Bird Electronics  
**Manufacturer's Address:** 13431 NE 20<sup>th</sup> Street  
Bellevue, WA 98005, USA

**The Authorized Representative located within the Community is:**  
OTT MESSTECHNIK GmbH & Co.KG  
P.O.Box: 2140 / 87411 Kempten / Germany  
Ludwigstrasse 16 / 87437 Kempten  
Internet: <http://www.ott.com>  
Phone: +49 831 5617 - 100  
Fax: +49 831 5617 - 209

**Device Description:** Various Data Acquisition Devices and Sensors

**Model Numbers:**

3S	3F	3plus	4C	4M	5T	5P	5M	7
8	9plus	11plus	14	16plus V2	16plus-IM V2		17plus V2	18
19plus V2	21	25plus	26plus	27	29	32	32C	32SC
33	35	35RT	36	37-IMP	37-IM	37-SMP	37-SM	37-SIP
37-SI	38	39	39-IM	39plus	41	41CP	43	43F
44	45	49	50	52-MP	53BPR	54	55	56
63	SIM	ICC	IMM	PDIM	AFM	90488	90204	90402
90504	Glider Payload CTD		NiMH Battery Charger and Battery Pack					

**Applicable EU Directives:** Machinery Directive 98 / 37 /EC  
EMC Directive 2004 / 108 /EC  
Low Voltage Directive (73 / 23 /EEC) as amended by (93 / 68 /EEC)

**Applicable Harmonized Standards:**  
EN 61326-1:2006 Class A Electrical Equipment for Measurement, Control, and Laboratory Use, EMC Requirement – Part 1: General Requirements  
(EN 55011:2007 Group 1, Class A)  
  
EN 61010-1:2001, Safety Requirements for Electrical Equipments for Measurement, Control, and Laboratory Use – Part 1: General Requirements

Declaration based upon compliance to the Essential Requirements and Letter of Opinion from CKC Certification Services, LLC., Notified Body 0976

I, the undersigned, hereby declare that the equipment specified above conforms to the above European Union Directives and Standards.

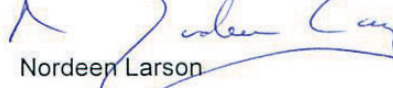
**Authorized Signature:**   
**Name:** Nordeen Larson  
**Title of Signatory:** President  
**Date:** 3 September 2013  
**Place:** Bellevue, WA

# Table of Contents

<b>Limited Liability Statement</b> .....	<b>2</b>
<b>Declaration of Conformity</b> .....	<b>3</b>
<b>Table of Contents</b> .....	<b>4</b>
<b>Section 1: Introduction</b> .....	<b>6</b>
About this Manual .....	6
Quick Start .....	7
Unpacking HydroCAT.....	8
Shipping Precautions .....	9
<b>Section 2: Description of HydroCAT</b> .....	<b>10</b>
System Description .....	10
Specifications.....	12
Dimensions and End Cap Connector .....	13
Cables and Wiring .....	14
Pump Operation .....	15
Minimum Conductivity Frequency for Pump Turn-On .....	15
Pumping Time and Speed - DO Sensor NOT Installed .....	15
Pumping Time and Speed – DO Sensor Installed .....	15
Sample Timing.....	17
Battery Pack Endurance .....	17
External Power.....	20
Cable Length and External Power .....	20
<b>Section 3: Preparing HydroCAT for Deployment</b> .....	<b>22</b>
Battery Pack Installation .....	22
Software Installation .....	24
Power and Communications Test .....	24
Test Setup .....	24
Test .....	25
<b>Section 4: Deploying and Operating HydroCAT</b> .....	<b>26</b>
Sampling Modes .....	26
Polled Sampling.....	27
Autonomous Sampling (Logging commands).....	28
RS-232 Real-Time Data Acquisition .....	29
Timeout Description .....	29
Command Descriptions – Transmission via RS-232 .....	29
Command Descriptions and Data Output Format – Transmission via SDI-12	30
SDI-12 Standard Commands .....	30
SDI-12 Extended Commands .....	32
SDI-12 Data Format .....	33
RS-232 Data Formats.....	34
Optimizing Data Quality.....	38
Setup for Deployment.....	39
Deployment.....	40
Recovery .....	41
Uploading Data .....	42

<b>Section 5: Routine Maintenance and Calibration</b> .....	<b>43</b>
Corrosion Precautions.....	43
Connector Mating and Maintenance.....	43
Conductivity Cell and (optional) Dissolved Oxygen Maintenance.....	44
Pump Maintenance.....	44
Handling Instructions.....	45
Replacing AA Cells.....	46
O-Ring Maintenance.....	46
Pressure Sensor (optional) Maintenance.....	46
Replacing Anti-Foulant Devices – Mechanical Design Change.....	47
Replacing Anti-Foulant Devices (SBE 37-SI, SM, IM).....	47
Sensor Calibration.....	49
Conductivity Sensor Calibration.....	49
Temperature Sensor Calibration.....	49
Dissolved Oxygen Sensor (optional) Calibration.....	49
Pressure Sensor (optional) Calibration.....	50
<b>Section 6: Troubleshooting</b> .....	<b>51</b>
Problem 1: Unable to Communicate with HydroCAT.....	51
Problem 2: No Data Recorded.....	51
Problem 3: Unreasonable T, C, P, or D.O. Data.....	51
Problem 4: Salinity Spikes.....	52
<b>Glossary</b> .....	<b>53</b>
<b>Appendix I: Functional Description</b> .....	<b>54</b>
Sensors.....	54
Sensor Interface.....	54
Real-Time Clock.....	54
<b>Appendix II: Electronics Disassembly/Reassembly</b> .....	<b>55</b>
<b>Appendix III: RS-232 Command Summary and Details</b> .....	<b>59</b>
Command Summary.....	60
Detailed Command Descriptions.....	63
<b>Appendix IV: AF24173 Anti-Foulant Device</b> .....	<b>83</b>
<b>Appendix V: Replacement Parts</b> .....	<b>87</b>
<b>Appendix VI: Manual Revision History</b> .....	<b>88</b>
<b>Index</b> .....	<b>89</b>

# Section 1: Introduction

This section includes a Quick Start procedure, photos of a typical HydroCAT shipment, and battery shipping precautions.

---

## About this Manual

This manual is to be used with the HydroCAT Conductivity, Temperature, (optional) Pressure, and Optional Dissolved Oxygen Recorder with SDI-12 and RS-232 serial interfaces, internal memory, and integral pump. It is organized to guide the user from installation through operation and data collection. We've included detailed specifications, command descriptions, maintenance and calibration information, and helpful notes throughout the manual.

Sea-Bird welcomes suggestions for new features and enhancements of our products and/or documentation. Please contact us with any comments or suggestions ([support@sea-birdcoastal.com](mailto:support@sea-birdcoastal.com) or +1 425-401-7653). Our business hours are Monday through Friday, 0800 to 1700 Pacific Standard Time (1600 to 0100 Universal Time) in winter and 0800 to 1700 Pacific Daylight Time (1500 to 0000 Universal Time) the rest of the year.

## Quick Start

Follow these steps to get a Quick Start using the HydroCAT with the Universal Coastal Interface (UCI) software.

The manual provides step-by-step details for performing each task:

1. Install new AA lithium cells and test power and communications (*Section 3*).
2. Set up, test, and deploy HydroCAT (*Sections 3 and 4*):
  - A. Via **Transfer Data** in UCI, ensure all data has been uploaded.
  - B. (if desired) Via **Temperature Check** in UCI, verify the temperature output stability and accuracy.
  - C. (if desired) Via **Conductivity Check** in UCI, verify the conductivity output stability and accuracy.
  - D. Via **HydroCAT Settings** in UCI, establish setup parameters.
  - E. Via **Command Terminal** in UCI, check configuration (**GetCD**) and calibration coefficients (**GetCC**) to verify setup.
  - F. Via **Start** in UCI, start autonomous sampling and view data in the Real Time Display and the Time Series plot to verify setup and operation. Click **Stop** when you are done.
  - G. Via **Deploy HydroCAT** in UCI:
    - Set Operating Mode (Autonomous or Polled Sampling).
      - For Autonomous Sampling: set sample interval and start date and time.
      - For Polled Sampling: set SDI-12 address and bad data flag.
    - Set parameters to output and parameter units for real-time data.
    - Synchronize time in HydroCAT with computer time, and (if desired) make entire memory available for recording.
  - H. Remove yellow protective label from plumbing intake and exhaust. Remove copper anti-foulant assembly and anti-foulant cap, and verify AF24173 Anti-Foulant Devices are installed (*Section 5: Routine Maintenance and Calibration*). Replace cap and assembly. Leave label off for deployment.
  - I. Install dummy plug or cable connector, and locking sleeve.
  - J. For SDI-12 deployments: Program SDI-12 controller to send periodic requests to run pump and sample (aM!, aMC!, aC!, or aCC! store data in HydroCAT FLASH memory; aM1!, aMC1!, aC1!, or aCC1! do not store data in FLASH memory), and then transmit sample (aD0!, aD1!).
  - K. Deploy HydroCAT. For **most** applications, mount the HydroCAT with the connector at the top (sensors at bottom) for proper operation.
  - L. Via **Transfer Data** in UCI, upload data from memory.

### Notes for Autonomous Sampling:

- You can program an RS-232 controller to send periodic requests to transmit the last data sample from the HydroCAT memory (**SL**) while sampling autonomously.
- You cannot view real-time autonomous data **in UCI** if you start autonomous sampling via **Deploy HydroCAT**. UCI automatically disconnects from the HydroCAT when you click **Finish**, and automatically sends a command to stop logging when you reconnect. If desired, you can connect to the HydroCAT with a terminal program to view real-time data.

# Unpacking HydroCAT

Shown below is a typical HydroCAT shipment.



HydroCAT



12 AA lithium cells



I/O cable



Spare hardware and o-ring kit



Conductivity cell cleaning solution (Triton-X)



Software, and Electronic Copies of Software Manuals and User Manual



## Shipping Precautions

### DISCLAIMER / WARNING:

The shipping information provided in is a general overview of lithium battery shipping requirements; it does not provide complete shipping information. The information is provided as a courtesy, to be used as a guideline to assist properly trained shippers. These materials do not alter, satisfy, or influence any federal or state requirements. These materials are subject to change due to changes in government regulations. Sea-Bird accepts no liability for loss or damage resulting from changes, errors, omissions, or misinterpretations of these materials. **See the current edition of the IATA Dangerous Good Regulations for complete information on packaging, labeling, and shipping document requirements.**



**WARNING!**  
Do not ship assembled battery pack.

Assembled battery pack

For its main power supply, the HydroCAT uses twelve 3.6-volt AA lithium cells (Saft LS14500). The HydroCAT was shipped from the factory with the cells packaged separately within the shipping box (not inside HydroCAT).

### BATTERY PACKAGING

Cells are packed in heat-sealed plastic, and then placed in bubble-wrap outer sleeve and strong packaging for shipment.



If the shipment is not packaged as described above, or does not meet the requirements below, the shipment is considered Dangerous/Hazardous Goods, and must be shipped according to those rules.

	1-5 HydroCATs and associated cells, but no spares	1-5 HydroCATs and associated cells, plus up to 2 spare cell sets/HydroCAT	Spares (without HydroCATs) – Note new rules as of January 1, 2013
UN #	UN3091	UN3091	<p>Must be shipped as <b>Class 9 Dangerous Goods</b>. If re-shipping spares, you must have your own Dangerous Goods program.</p>
Packing Instruction (PI) #	969	969	
Passenger Aircraft	Yes	No	
Cargo Aircraft	Yes	Yes	
Labeling Requirement	1 **	1, 2 **	
Airway Bill (AWB) Requirement	Yes *	Yes *	

\* AWB must contain following information in Nature and Quantity of Goods Box: "Lithium Metal Batteries", "Not Restricted", "PI #"

\*\* Labels are defined below:



2

**1 – Shipper must provide an emergency phone number**

### Note:

Remove the cells before returning the HydroCAT to Sea-Bird. Do not return used cells when shipping the HydroCAT for calibration or repair. All setup information is preserved when the cells are removed.

Install the lithium battery pack assembly in the HydroCAT for testing (see *Battery Pack Installation* in Section 3). **If you will re-ship the HydroCAT after testing:**

1. Remove the battery pack assembly from the HydroCAT.
2. Remove the cells from the battery pack assembly.
3. Pack the cells properly for shipment, apply appropriate labels, and prepare appropriate shipping documentation.

# Section 2: Description of HydroCAT

This section describes the functions and features of the HydroCAT, including specifications, dimensions, end cap connectors, sample timing, battery pack endurance, and external power.

## System Description



For most applications, deploy in orientation shown (connector end up) for proper operation – see *Optimizing Data Quality* in *Section 4: Deploying and Operating HydroCAT*

**Note:**

If connected to a USB port, a RS-232 to USB converter is required. See *Application Note 68: Using USB Ports to Communicate with Sea-Bird Instruments*.

The HydroCAT is a high-accuracy conductivity and temperature recorder (pressure optional) with internal battery pack and non-volatile memory, an integral pump, an SDI-12 interface, and an RS-232 serial interface. The HydroCAT also includes an (optional) Optical Dissolved Oxygen (DO) sensor (Hydro-DO). Designed for moorings and other long-duration, fixed-site deployments, these HydroCATs have non-corroding plastic housings rated for operation to 350 meters (1150 feet) or pressure sensor full-scale range.

For setup and data upload, communication with the HydroCAT is over an internal, 3-wire, RS-232C link. Over 50 different commands can be sent to the HydroCAT to provide status display, data acquisition setup, data retrieval, and diagnostic tests.

User-selectable operating modes include:

- **Autonomous sampling** (not compatible with SDI-12 deployments) – At pre-programmed intervals, the HydroCAT wakes up, runs the pump, samples, stores the data in its FLASH memory, and goes to sleep. If desired, real-time data can also be transmitted.
- **Polled sampling** – On command, the HydroCAT runs the pump, takes one sample, and transmits the data. Alternatively, the HydroCAT can be commanded to transmit the last sample in its memory while it is sampling autonomously. Polled sampling is useful for integrating the HydroCAT with satellite, radio, or wire telemetry equipment.

The HydroCAT can be deployed in three ways:

- **Connected to RS-232 or USB port** on computer – The HydroCAT can be remotely controlled, allowing for polled sampling or for periodic requests of data from the HydroCAT memory while the HydroCAT is sampling autonomously. If desired, data can be periodically uploaded while the HydroCAT remains deployed. The HydroCAT can be externally powered.
- **Connected to SDI-12 controller** - The HydroCAT can be remotely controlled, allowing for polled sampling. The HydroCAT can be externally powered.
- **Dummy plug installed** – The HydroCAT cannot be remotely controlled or externally powered. Autonomous sampling is programmed before deployment, and data is uploaded after recovery.

Calibration coefficients stored in EEPROM allow the HydroCAT to transmit conductivity, temperature, pressure, and oxygen data in engineering units. The HydroCAT retains the temperature and conductivity sensors used in the Sea-Bird Electronics' SeaCAT and SeaCAT*plus* family. The HydroCAT's aged and pressure-protected thermistor has a long history of exceptional accuracy and stability (typical drift is less than 0.002 °C per year). Electrical isolation of the conductivity electronics eliminates any possibility of ground-loop noise.



Shown with conductivity cell guard and anti-foulant fittings removed

The HydroCAT's internal-field conductivity cell is immune to proximity errors and unaffected by external fouling. The conductivity cell guard retains the expendable AF24173 Anti-Foulant Devices.

The HydroCAT's integral pump runs each time the HydroCAT takes a sample, providing the following advantages over a non-pumped system:

- Improved conductivity and oxygen response – The pump flushes the previously sampled water from the conductivity cell and oxygen sensor plenum, and brings a new water sample quickly into the system.
- Improved anti-foul protection – Water does not freely flow through the conductivity cell between samples, allowing the anti-foul concentration inside the system to maintain saturation.
- Improved measurement correlation – The individually calibrated Hydro-DO Optical Dissolved Oxygen sensor is integrated within the CTD flow path, providing optimum correlation with CTD measurements.

When the optional dissolved oxygen sensor is installed, the HydroCAT's *Adaptive Pump Control* algorithm calculates the pump run time for best dissolved oxygen accuracy, as a function of the temperature and pressure of the previous sample. When the dissolved oxygen sensor is not installed, the pump runs for 1.0 second before each sample.

The HydroCAT's optional strain-gauge pressure sensor is available in the following pressure ranges: 20, 100, and 350 meters. Compensation of the temperature influence on pressure offset and scale is performed by the HydroCAT's CPU.

Future upgrades and enhancements to the HydroCAT firmware can be easily installed in the field through a computer serial port and the bulkhead connector on the HydroCAT, without the need to return the HydroCAT to Sea-Bird.

#### Notes:

- Help files provide detailed information on the use of the software.
- Sea-Bird supplies the current version of our software when you purchase an instrument. As software revisions occur, we post the revised software. See our website ([www.sea-birdcoastal.com](http://www.sea-birdcoastal.com)) for the latest software version number, a description of the software changes, and instructions for downloading the software.

The HydroCAT is supplied with a powerful Windows software package that includes software for determining deployment length and for setting up, running validation checks, uploading data, and plotting data from the HydroCAT.

## Specifications

	Temperature	Conductivity	Pressure	Dissolved Oxygen										
<b>Measurement Range</b>	-5 to +45 °C	0 to 7 (0 to 70 mS/cm)	0 to full scale range: 20 / 100 / 350 meters (expressed in meters of deployment depth capability)	See Hydro-DO Optical Dissolved Oxygen Sensor manual										
<b>Initial Accuracy</b>	± 0.002 (-5 to 35 °C); ± 0.01 (35 to 45 °C)	± 0.0003 (0.003 mS/cm)	± 0.1% of full scale range											
<b>Typical Stability</b>	0.0002 °C / month	0.0003 (0.003 mS/cm) / month	0.05% of full scale range / year											
<b>Resolution</b>	0.0001 °C	0.00001 (0.0001 mS/cm)	0.002% of full scale range											
<b>Sensor Calibration</b> (measurement outside these ranges may be at slightly reduced accuracy due to extrapolation errors)	+1 to +32 °C	0 to 6; physical calibration over range 2.6 to 6 S/m, plus zero conductivity (air)	Ambient pressure to full scale range in 5 steps											
<b>Memory</b>	8 Mbyte non-volatile FLASH memory													
<b>Data Storage</b>	Conductivity & temperature: 6 bytes/sample (3 bytes each). Time: 4 bytes/sample. Oxygen: 6 bytes/sample. Pressure (optional): 5 bytes/sample.													
	<table border="1"> <thead> <tr> <th><u>Recorded Parameters</u></th> <th><u>Memory Space (number of samples)</u></th> </tr> </thead> <tbody> <tr> <td>C, T, and time</td> <td>800,000</td> </tr> <tr> <td>C, T, P, and time</td> <td>533,000</td> </tr> <tr> <td>C, T, DO, and time</td> <td>500,000</td> </tr> <tr> <td>C, T, P, DO, and time</td> <td>381,000</td> </tr> </tbody> </table>				<u>Recorded Parameters</u>	<u>Memory Space (number of samples)</u>	C, T, and time	800,000	C, T, P, and time	533,000	C, T, DO, and time	500,000	C, T, P, DO, and time	381,000
<u>Recorded Parameters</u>	<u>Memory Space (number of samples)</u>													
C, T, and time	800,000													
C, T, P, and time	533,000													
C, T, DO, and time	500,000													
C, T, P, DO, and time	381,000													
<b>Real-Time Clock</b>	32,768 Hz TCXO accurate to ±1 minute/year.													
<b>Internal Battery Pack</b>	Nominal 7.8 Amp-hour pack consisting of 12 AA Saft LS 14500 lithium cells (3.6 V and 2.6 Amp-hours each), with 3 strings of 4 cells. For battery pack endurance calculations, derated capacity of 257 KJoules. See <i>Battery Pack Endurance</i> for example sampling calculation. See <i>Shipping Precautions</i> in <i>Section 1: Introduction</i> . Note: Saft batteries can be purchased from Sea-Bird or other sources. See Saft's website for suppliers ( <a href="http://www.saftbatteries.com">www.saftbatteries.com</a> ). Alternatively, substitute either of the following: - Tadiran TL-4903, AA (3.6 V and 2.4 Amp-hours each) ( <a href="http://www.tadiran.com">www.tadiran.com</a> ) - Electrochem 3B0064/BCX85, AA (3.9 V and 2.0 Amp-hours each) ( <a href="http://www.electrochemsolutions.com">www.electrochemsolutions.com</a> )													
<b>External Power</b>	0.25 Amps at 9 - 24 VDC. To avoid draining internal battery pack, use an external voltage greater than 16 VDC. See <i>External Power</i> .													
<b>Power Consumption</b>	<ul style="list-style-type: none"> <li>• Quiescent: 78 microAmps (0.001 Watts)</li> <li>• Pump: <ul style="list-style-type: none"> <li>Without Oxygen sensor: 25.3 milliAmps (0.025 Amp-sec per 1.0 sec pulse)</li> <li>With Oxygen sensor: 0.12 Watts (see <i>Pump Operation</i> for time that pump runs)</li> </ul> </li> <li>• CTD Sample Acquisition (without Oxygen sensor) <ul style="list-style-type: none"> <li>- 9.1 milliAmps if transmitting real-time RS-232 data.</li> <li>- 7.9 milliAmps if not transmitting real-time RS-232 data.</li> <li>- Acquisition time: 1.9 – 2.9 sec/sample (depends on sampling mode and inclusion of pressure sensor, see <i>Sample Timing</i>).</li> </ul> </li> <li>• CTD+DO Sample Acquisition, with pressure (excluding pump): <ul style="list-style-type: none"> <li>Real-time data enabled – 0.17 Watts (see <i>Sample Timing</i> for acquisition time)</li> <li>Real-time data disabled – 0.155 Watts (see <i>Sample Timing</i> for acquisition time)</li> </ul> </li> <li>• CTD+DO Sample Waiting (pump running, not sampling), with pressure (excluding pump): <ul style="list-style-type: none"> <li>Real-time data enabled and receive line valid – 0.056 Watts</li> <li>Real-time data enabled and receive line not valid – 0.016 Watts</li> <li>Real-time data disabled – 0.016 Watts</li> </ul> </li> <li>• CTD+DO Between Samples, with pressure: <ul style="list-style-type: none"> <li>Real-time data enabled and receive line valid – 0.056 Watts</li> <li>Real-time data enabled and receive line not valid – 0.0004 Watts</li> <li>Real-time data disabled – 0.0004 Watts</li> </ul> </li> <li>• Communications: RS-232 - 4.3 milliAmps (0.065 Watts); SDI-12 - 2.0 milliAmps (0.024 Watts)</li> </ul>													
<b>Housing Material and Depth Rating</b>	Plastic housing rated at 350 m (1150 ft)													
<b>Weight</b> (with mooring guide and clamp)	3.0 kg (6.6 lbs) in air, 1.4 kg (3.0 lbs) in water													

### Dimensions and End Cap Connector

**Note:**  
For most applications, deploy in the orientation shown (connector end up) for proper operation.

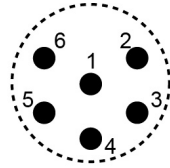

Wet-Pluggable  
MCBH-6MP (WB), TI  
(3/8" length base,  
1/2-20 thread)

Pin	Signal
1	Common
2	RS-232 data receive
3	RS-232 data transmit
4	SDI-12 data transmit
5	--
6	9-24 VDC external power

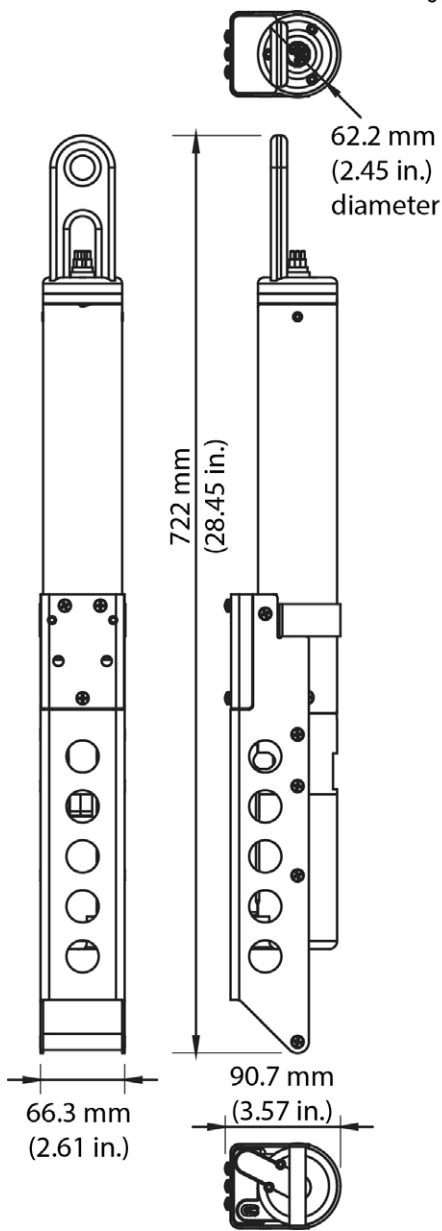

**Without Optional  
Dissolved Oxygen Sensor**

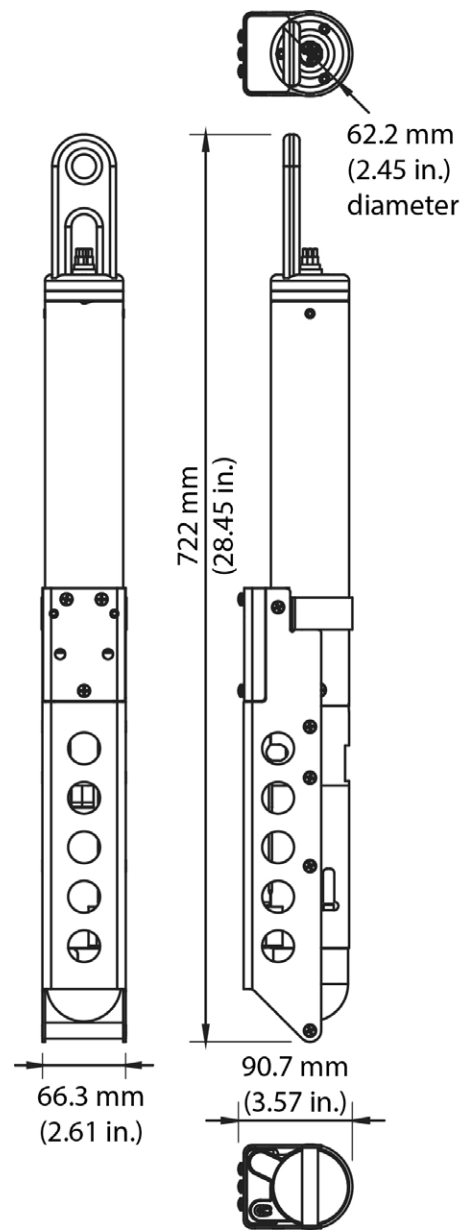

**With Optional  
Dissolved Oxygen Sensor**

### Cables and Wiring

#### MCIL Wet-Pluggable Connector Cable Wiring -- DN 33733

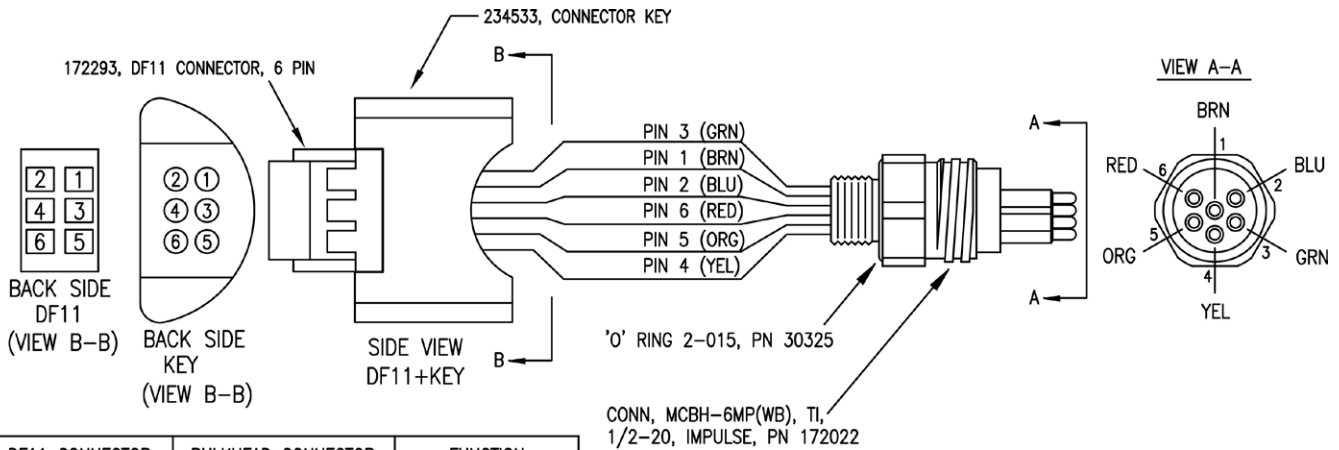
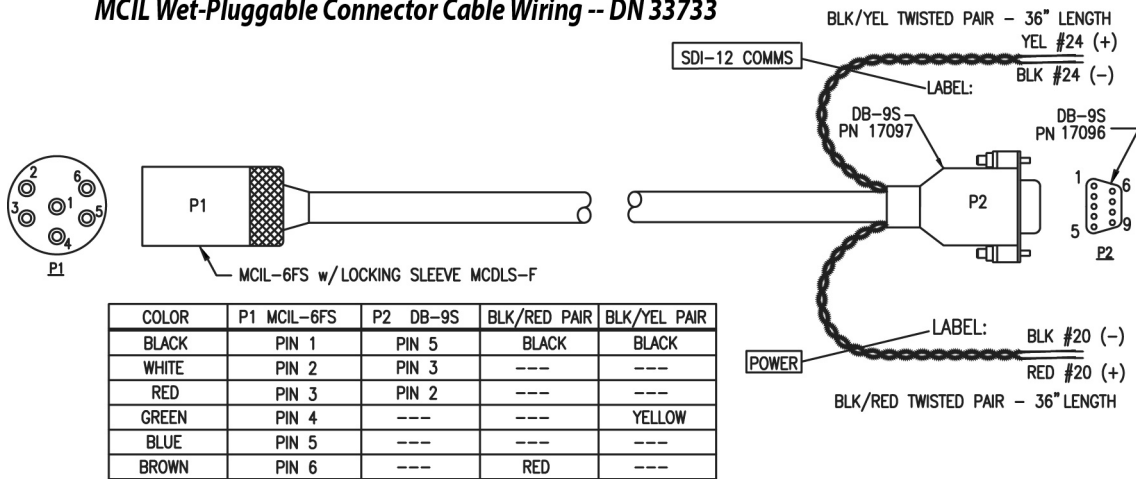

DF11 CONNECTOR	BULKHEAD CONNECTOR	FUNCTION
PIN 1	PIN 3 (GRN)	TX TO PC
PIN 2	PIN 1 (BRN)	COMMON
PIN 3	PIN 2 (BLU)	RX FROM PC
PIN 4	PIN 6 (RED)	EXTERNAL PWR
PIN 5	PIN 5 (ORG)	NO CONNECT
PIN 6	PIN 4 (YEL)	SDI-12

## Pump Operation

### Minimum Conductivity Frequency for Pump Turn-On

The HydroCAT's integral pump is water lubricated; running it *dry* for an extended period of time will damage it. To prevent the pump from running dry while sampling, the HydroCAT checks the raw conductivity frequency (Hz) from the last sample against the user-input Minimum Conductivity Frequency. If the raw conductivity frequency is greater than the Minimum Conductivity Frequency, it runs the pump before taking the sample; otherwise it does not run the pump.

The HydroCAT Calibration Sheet lists the uncorrected (raw) frequency output at 0 conductivity (also called the zero conductivity frequency).

- A typical Minimum Conductivity Frequency value (and factory-set default) for salt water and estuarine applications is (zero conductivity frequency + 500 Hz).
- A typical Minimum Conductivity Frequency value for fresh water applications is (zero conductivity frequency + 5 Hz).

If the minimum conductivity frequency is too close to the *zero conductivity frequency* (from the HydroCAT Calibration Sheet), the pump may turn on when the HydroCAT is in air, as a result of small drifts in the electronics. Some experimentation may be required to control the pump, particularly in fresh water applications.

By setting the Minimum Conductivity Frequency to an appropriate value, you can start logging in the lab or on the ship in dry conditions; the pump will not run until you deploy the HydroCAT. Upon recovery, the HydroCAT will continue logging data but the pump will stop running, so a delay in getting the HydroCAT to the lab to stop logging will not damage the pump.

### Pumping Time and Speed - DO Sensor NOT Installed

When the optional dissolved oxygen sensor is not installed, the HydroCAT runs the pump for 1.0 second before each sample.

### Pumping Time and Speed – DO Sensor Installed

When the optional dissolved oxygen sensor is installed, the pump runs before and during sampling, flushing the system consistent with the calibration of the oxygen sensor at our factory. The time that the pump runs for each sample is a function of whether *Adaptive Pump Control* is enabled.

- If Adaptive Pump Control is enabled, the HydroCAT calculates the pump time **before** each sample for best oxygen accuracy, as a function of the previous sample's temperature and pressure (temperature and pressure influence the oxygen sensor time constant). Pump time increases with increasing pressure and decreasing temperature. The pump continues to run while sampling. See next page for algorithm.
- If Adaptive Pump Control is not enabled, the pump runs for a user-programmable time (multiple of oxygen sensor response time) **before** each sample, and then continues to run while sampling. **Adaptive pump control should be disabled only for testing and calibration.**

$$\text{pump time} = \text{OxNTau} * \text{OxTau20}$$

where

  - OxTau20 = oxygen calibration coefficient programmed in HydroCAT
  - OxNTau = pump time multiplier programmed in HydroCAT

**Note:**

The pump continues to run while the HydroCAT takes the sample. See *Sample Timing* below for the time to take each sample, which varies depending on the sampling mode, command used to start sampling, whether real-time data is transmitted, and whether the HydroCAT includes a pressure sensor.

For testing and/or to remove sediment from inside the plumbing, the pump can be *manually* turned on and off with the commands sent through a terminal program.

The *Adaptive Pump Control* algorithm and operation is detailed below.

**Notes:**

- OxTau20 is programmed into the HydroCAT at the factory.
- If the HydroCAT does not include a pressure sensor, the *Adaptive Pump Control* algorithm uses the user-input Reference Pressure in place of the measured pressure.
- The calculated Pump Time does not include the pumping while sampling.

$$ft = A + (B * T) + (C * T^2)$$

$$fp = e^{(pcor * P)}$$

$$\text{tau} = \text{OxTau20} * ft * fp \quad (\text{minimum tau 2.0, maximum tau 30.0})$$

$$\text{pump time} = \text{OxNTau} * \text{tau} \quad (\text{minimum pump time 3.0 sec})$$

where

- A = 2.549
- B = -1.106 x 10<sup>-1</sup>
- C = 1.571 x 10<sup>-3</sup>
- pcor = 1.45 x 10<sup>-4</sup>
- OxTau20 = oxygen calibration coefficient in HydroCAT
- OxNTau = pump time multiplier in HydroCAT
- P = measured pressure (decibars)
- T = measured temperature (°C)

Looking at pump times in the range of oceanographic values, and using a typical OxTau20 value of 5.5 and OxNTau value of 7.0:

(for OxTau20=5.5 and OxNTau=7.0)					
T (°C)	P (db)	Ft	Fp	Tau	Pump Time before sampling (sec)
-3	1500	2.89	1.24	19.7	138
-3	0	2.89	1.0	15.9	111
0	0	2.549	1.0	14.0	98
0	1500	2.549	1.24	17.3	121
4	0	2.132	1.0	11.7	82
4	1500	2.132	1.24	14.5	102
20	0	0.9654	1.0	5.3	37
20	1500	0.9654	1.24	6.6	46

**Note that the adaptive pump control operation can impact the interval between samples.** The total time for each sample is the calculated pump time plus the actual sampling time (the pump continues to run while sampling). The HydroCAT requires a minimum of 3 seconds after taking a sample to the start of the next sampling interval. If the time required to run the pump is too large, it will not be able to take samples at the user-programmed Sample Interval. If that occurs, the HydroCAT starts the next sampling interval 5 seconds after the end of the previous sampling interval.

Sea-Bird recommends that you calculate the expected pumping time based on the algorithm above, the planned deployment pressure, and the worst (i.e., the coldest) expected temperature. Do not set the Sample Interval to less than (pumping time + sampling time + 5 sec).



## Sample Timing

### Notes:

- Acquisition time shown does not include time to transmit real-time data, which is dependent on baud rate and number of characters being transmitted (defined by commands to enable/disable specific output parameters). These are set in the HydroCAT Settings dialog.
- Time stored and output with the data is the time at the **start** of the sample, after the HydroCAT wakes up, runs the pump, and prepares to sample.

Sample timing is dependent on several factors, including sampling mode, command used to start sampling, whether real-time data is transmitted, and whether the HydroCAT includes a pressure sensor and / or a dissolved oxygen sensor.

- If optional dissolved oxygen sensor not installed – The pump runs for 1.0 second while the Wein bridge is stabilizing before each measurement.
- If optional dissolved oxygen sensor installed – The pumping time is dependent on *Adaptive Pump Control*, as described above in *Pumping Time and Speed*.

### Autonomous Sampling (time between samples = Sample Interval)

Power on time for each sample while logging, if not transmitting real-time RS-232 data:

- **Without pressure, without oxygen:** power-on time = 1.9 sec to run pump and sample
- **With pressure, without oxygen:** power-on time = 2.6 sec to run pump and sample
- **Without pressure, with oxygen:** power-on time = 2.4 sec

If transmitting real-time data, add 0.4 sec to the time.

### Polled Sampling

Time from receipt of take sample command to beginning of reply:

- **Without pressure, without oxygen:** power-on time = 1.9 sec to run pump and sample
- **With pressure, without oxygen:** power-on time = 2.6 sec to run pump and sample
- **Without pressure, with oxygen:** power-on time = 2.7 sec
- **With pressure, with oxygen:** power-on time = 3.1 sec

## Battery Pack Endurance

### Notes:

- If the HydroCAT is logging data and the battery voltage is less than 7.1 volts for five consecutive scans, the HydroCAT halts logging.
- Sea-Bird recommends using the capacity value of 6.0 Amp-hours for the Saft cells as well as the alternate cell types (Tadiran TL-4903 and Electrochem 3B0064/BCX85 AA).
- **See *Specifications* above for data storage limitations.**

The battery pack (4 cells in series, 3 parallel strings) has a nominal capacity of 7.8 Amp-hours (2.6 Amp-hours \* 3). For planning purposes, to account for the HydroCAT's current consumption patterns and for environmental conditions affecting cell performance, **Sea-Bird recommends using a conservative value of 6.0 Amp-hours.**

- Power consumption is defined above in *Specifications*.
- The time required for data acquisition for each sample is defined above in *Sample Timing*.
- The pump time using the Adaptive Pump Control algorithm is described above in *Pumping Time and Speed – DO Sensor Installed*. If the HydroCAT does not include a dissolved oxygen sensor, the pump runs for 1.0 second before each sample.

So, battery pack endurance is highly dependent on the application. An example is shown below for one sampling scheme. **You can use the Deployment Endurance Calculator** (part of the Seasoft V2 software package) to determine the maximum deployment length, instead of performing the calculations by hand.

- If your HydroCAT does not include the optional Dissolved Oxygen sensor, select **SBE 37 – Integral Pump (SMP, IMP)** in the Deployment Endurance Calculator.
- If your HydroCAT does include the optional Dissolved Oxygen sensor, select **SBE 37 – Integral Pump & Optical Oxygen (SMP-ODO, IMP-ODO)** in the Deployment Endurance Calculator.

### Note:

HydroCAT is similar to Sea-Bird Electronics' SBE 37-SMP and 37-SMP-ODO. Deployment Endurance Calculator was developed for those products.

**Example 1 (with pressure, no oxygen) - real-time RS-232 communication at 9600 baud:**

A HydroCAT with pressure sensor and without oxygen is sampling autonomously every 5 minutes (12 samples/hour), and is transmitting real-time RS-232 data. The HydroCAT is set up to transmit salinity, sound velocity, and specific conductivity as well as C, T, and P, all in converted decimal format. How long can it be deployed?

**Sampling time** (autonomous sampling, with pressure sensor) = 2.9 sec

Sampling current consumption = 0.0091 Amp \* 2.6 sec = 0.021 Amp-sec/sample

In 1 hour, sampling current consumption = 12 \* 0.021 Amp-sec/sample = **0.25 Amp-sec/hour**

**Pump current consumption** = 0.025 Amp-sec/pulse

In 1 hour, pump current consumption = 12 \* 0.025 Amp-sec/pulse = **0.3 Amp-sec/hour**

**Quiescent current** = 78 microAmps = 0.078 mA = 0.000078 A

In 1 hour, quiescent current consumption ≈ 0.000078 A \* 3600 sec/hour = **0.28 Amp-sec/hour**

**Communications** (4.3 mA) – assume outputting temperature, conductivity, pressure, salinity, sound velocity, specific conductivity, sample number; see *RS-232 Data Formats* in *Section 4: Deploying and Operating HydroCAT*.

Number of characters transmitted/sample = 12 (ID) + 2(comma&space) + 7(T) + 2(comma&space) + 7(C) + 2 + 7(P) + 2 + 8(salinity) + 2 + 8 (sound velocity) + 2 + 7(specific conductivity) + 2(comma&space) + 11 (date) + 2 + 8 (time) + 2 + 6 = 99

Time required to transmit data = 99 characters \* 10 bits/character / 9600 baud = 0.1 sec

Communication current consumption/sample = 0.0043 A \* 0.1 sec = 0.0004 Amp-sec

In 1 hour, consumption = 6 samples/hour \* 0.0004 = 0.003 Amp-sec/hour (negligible, ignore)

Total current consumption / hour = 0.25 + 0.3 + 0.28 = 0.83 Amp-sec/hour

Capacity = (6.0 Amp-hours \* 3600 sec/hr) / (0.83 Amp-sec/hour) = 26000 hours = 1084 days = 3.0 years

**However, Sea-Bird recommends that cells should not be expected to last longer than 2 years in the field.**

Number of samples = 27,000 hours \* 12 samples/hour = 312,000 samples

**Example 2 – Same as Example 1, but SDI-12 controller polls for last sample to be transmitted 12 times/hour. SDI-12 communication is always at 1200 baud:**

All values same as in Example 1, with exception of Communications power.

**Communications** (2.0 mA) – assume outputting temperature, conductivity, pressure, salinity, sound velocity, specific conductivity, sample number; see *SDI-12 Data Format* in *Section 4: Deploying and Operating HydroCAT*.

Number of characters transmitted/sample = 1 (address) + 10(T) + 10(C) + 10(P) + 10(salinity) + 9 (sound velocity) + 10(specific conductivity) + 7 (sample number) = 67

Time required to transmit data = 67 characters \* 10 bits/character / 1200 baud = 0.56 sec

Communication current consumption/sample = 0.002 A \* 0.56 sec = 0.001 Amp-sec

In 1 hour, consumption = 6 samples/hour \* 0.001 Amp-sec/sample = **0.006 Amp-sec**

Total current consumption / hour = 0.25 + 0.3 + 0.28 + 0.01 = 0.84 Amp-sec/hour

Capacity = (6.0 Amp-hours \* 3600 sec/hr) / (0.84 Amp-sec/hour) = 25714 hours = 1071 days = 2.9 years

**However, Sea-Bird recommends that cells should not be expected to last longer than 2 years in the field.**

Number of samples = 25,714 hours \* 12 samples/hour = 308,000 samples

**Examples continued on next page**

**Example 3 (with pressure and oxygen) – real-time RS-232 communication at 9600 baud:**

A HydroCAT with pressure and oxygen is sampling autonomously every 10 minutes (6 samples/hour). Real-time data is enabled, but the receive line is not valid between samples, to minimize the power required from the HydroCAT and from the controller. Adaptive Pump Control is enabled. The HydroCAT is set up to transmit salinity, sound velocity, and specific conductivity as well as C, T, P, and DO, all in converted decimal format. The HydroCAT is to be deployed at approximately 500 db; expected temperature there is approximately 10 °C. Oxtau20 (programmed into the HydroCAT at the factory) is 5.5, and OxNTau is 7.0. How long can it be deployed?

**CTD+DO Sampling** = 0.17 Watts \* 3.2 sec sampling time = 0.544 Joules/sample

In 1 hour, sampling consumption = 6 samples/hour \* 0.544 Joules/sample = **3.26 Joules/hour**

**Pump**

$ft = A + (B * T) + (C * T^2) = 2.549 + (-1.106 \times 10^{-1} * 10) + (1.571 \times 10^{-3} * 10 * 10) = 1.600$

$fp = e^{(pcor * P)} = e^{(1.45e-4 * 500)} = 1.075$

$\tau = OxTau20 * ft * fp = 5.5 * 1.600 * 1.075 = 9.46$

Pump Time = OxNTau \*  $\tau = 7.0 * 9.46 = 66.2$  sec (> Minimum Pump Time = 3 sec)

From above, pump runs for an additional 3.2 sec while sampling.

Pumping, 0.12 Watts \* (66.2 + 3.2) sec = 8.33 Joules/sample

In 1 hour, pump consumption = 6 samples/hour \* 8.33 Joules/sample = **49.98 Joules/hour**

**CTD-DO Waiting while pump running** = 0.016 Watts \* 66.2 sec = 1.06 Joules/sample

In 1 hour, consumption = 6 samples \* 1.06 Joules/sample = **6.36 Joules/hour**

**CTD-DO Waiting between Samples** = 0.001 Watts \* (600 – [66.2 + 3.2]) sec = 0.53 Joules/sample

In 1 hour, consumption = 6 samples/hour \* 0.53 Joules/sample = **3.18 Joules/hour**

**Communications** – assume outputting temperature, conductivity, pressure, oxygen, salinity, sound velocity, specific conductivity, sample number; see *RS-232 Data Formats* in *Section 4: Deploying and Operating HydroCAT*.

Number of characters transmitted/sample = 12(ID) + 2(comma&space) + 7(T) + 2(comma&space) + 7(C) + 2 + 7(P) + 2 + 6(DO) + 2 + 8(salinity) + 2 + 8 (sound velocity) + 2 + 7(specific conductivity) + 2(comma&space) + 11 (date) + 2 + 8 (time) + 2 + 6 = 93

Time required to transmit data = 107 characters \* 10 bits/character / 9600 baud = 0.1 sec

Communication power/sample = 0.065 Watts \* 0.1 sec = 0.065 Joules/sample

In 1 hour, consumption = 6 samples/hour \* 0.065 Joules/sample = **0.04 Joules/hour**

**Total consumption / hour** = 3.26 + 49.98 + 6.36 + 3.18 + 0.04 = **62.8 Joules/hour**

**Battery pack capacity**

Assume nominal voltage of 14 V and 85% DC/DC converter efficiency

14 V \* 6 Amp-hours \* 3600 sec/hour \* 0.85 = 257040 Joules

Capacity = 257040 Joules / 62.8 Joules/hour = 4093 hours = 170 days = **0.47 years**

Number of samples = 4093 hours \* 6 samples/hour = **24,558 samples**

**Example 4 – Same as Example 3, but SDI-12 controller polls for last sample to be transmitted 6 times/hour. SDI-12 communication is always at 1200 baud:**

All values same as in Example 1, with exception of Communications power.

**Communications** – assume outputting temperature, conductivity, pressure, oxygen, salinity, sound velocity, specific conductivity, sample number; see *Data Formats* in *Section 4: Deploying and Operating HydroCAT*.

Number of characters transmitted/sample = 1 (address) + 10(T) + 10(C) + 10(P) + 7(DO) + 10(salinity) + 9 (sound velocity) + 10(specific conductivity) + 7 (sample number) = 74

Time required to transmit data = 74 characters \* 10 bits/character / 1200 baud = 0.62 sec

Communication power/sample = 0.024 Watts \* (0.62) sec = 0.015 Joules/sample

In 1 hour, consumption = 6 samples/hour \* 0.015 Joules/sample = **0.09 Joules/hour**

**Total consumption / hour** = 3.26 + 49.98 + 6.36 + 3.18 + 0.09 = **62.9 Joules/hour**

**Battery pack capacity**

Capacity = 257040 Joules / 62.9 Joules/hour = 4087 hours = 170 days = **0.46 years**

Number of samples = 4087 hours \* 6 samples/hour = **24,522 samples**

## External Power

The HydroCAT can be powered from an external source that supplies 0.25 Amps at 9-24 VDC. The internal lithium pack is diode-OR'd with the external source, so power is drawn from whichever voltage source is higher. The HydroCAT can also be operated from the external supply without having the battery pack installed. Electrical isolation of conductivity prevents ground loop noise contamination in the conductivity measurement.

### Note:

See *Real-Time Data Acquisition* in *Section 4: Deploying and Operating HydroCAT* for baud rate limitations on cable length if transmitting real-time data.

### Note:

Common wire resistances:

Gauge	Resistance (ohms/foot)
12	0.0016
14	0.0025
16	0.0040
18	0.0064
19	0.0081
20	0.0107
22	0.0162
24	0.0257
26	0.0410
28	0.0653

## Cable Length and External Power

There are two issues to consider if powering the HydroCAT externally:

- Limiting the communication IR loss to 1 volt **if transmitting real-time data via RS-232**; higher IR loss will cause the instrument to transmit data that does not meet the RS-232 communication standard.
- Supplying enough power at the power source so that sufficient power is available at the instrument after considering IR loss.

Each issue is discussed below.

### *Limiting Communication IR Loss to 1 Volt if Transmitting Real-Time Data*

The limit to cable length is typically reached when the maximum **communication** current times the power common wire resistance is more than 1 volt.

$$V_{\text{limit}} = 1 \text{ volt} = IR_{\text{limit}}$$

$$\text{Maximum cable length} = R_{\text{limit}} / \text{wire resistance per foot}$$

where I = communication current required by HydroCAT (see *Specifications*: 4.3 milliAmps; round up to 5 milliAmps).

*Example 1* – For 20 gauge wire, what is maximum distance to transmit power to HydroCAT if transmitting real-time data?

For 5 milliAmp communications current,  $R_{\text{limit}} = V_{\text{limit}} / I = 1 \text{ volt} / 0.005 \text{ Amps} = 200 \text{ ohms}$

For 20 gauge wire, resistance is 0.0107 ohms/foot.

Maximum cable length =  $200 \text{ ohms} / 0.0107 \text{ ohms/foot} = 18691 \text{ feet} = 6568 \text{ meters}$

*Example 2* – Same as above, but there are 4 HydroCATs powered from the same power supply.

For 4.3 milliAmp communications current,  $R_{\text{limit}} = V_{\text{limit}} / I = 1 \text{ volt} / (0.005 \text{ Amps} * 4 \text{ HydroCATs}) = 50 \text{ ohms}$

Maximum cable length =  $50 \text{ ohms} / 0.0107 \text{ ohms/foot} = 4672 \text{ feet} = 1424 \text{ meters}$  (to HydroCAT *furthest* from power source)

### ***Supplying Enough Power to HydroCAT***

Another consideration in determining maximum cable length is supplying enough power at the power source so that sufficient voltage is available, after IR loss in the cable (***from the 0.25 Amp turn-on transient, two-way resistance***), to power the HydroCAT. The power requirement varies, depending on whether *any* power is drawn from the battery pack:

- Provide at least 16 volts, after IR loss, to prevent the HydroCAT from drawing **any** power from the battery pack (if you do not want to draw down the battery pack):  $V - IR \geq 16$  volts
- Provide at least 9 volts, after IR loss, if allowing the HydroCAT to draw down the battery pack or if no battery pack is installed:  $V - IR \geq 9$  volts  
where I = HydroCAT turn-on transient (0.25 Amps; see *Specifications*).

***Example 1*** – For 20 gauge wire, what is maximum distance to transmit power to HydroCAT if using 12 volt power source and deploying HydroCAT with no battery pack?

$$V - IR \geq 9 \text{ volts} \quad 12 \text{ volts} - (0.25 \text{ Amps}) * (0.0107 \text{ ohms/foot} * 2 * \text{cable length}) \geq 9 \text{ volts}$$

$$3 \text{ volts} \geq (0.25 \text{ Amps}) * (0.0107 \text{ ohms/foot} * 2 * \text{cable length}) \quad \text{Cable length} \leq 560 \text{ ft} = 170 \text{ meters}$$

Note that 170 m << 6568 m (maximum distance if HydroCAT is transmitting real-time data), so IR drop in power is controlling factor for this example. Using a higher voltage power supply or a different wire gauge would increase allowable cable length.

***Example 2*** – Same as above, but there are 4 HydroCATs powered from same power supply.

$$V - IR \geq 9 \text{ volts} \quad 12 \text{ volts} - (0.25 \text{ Amps} * 4 \text{ HydroCATs}) * (0.0107 \text{ ohms/foot} * 2 * \text{cable length}) \geq 9 \text{ volts}$$

$$3 \text{ volts} \geq (0.25 \text{ Amps} * 4 \text{ HydroCATs}) * (0.0107 \text{ ohms/foot} * 2 * \text{cable length})$$

Cable length  $\leq$  140 ft = 42 meters (to HydroCAT *furthest* from power source)

# Section 3: Preparing HydroCAT for Deployment

This section describes the pre-check procedure for preparing the HydroCAT for deployment. Installation of the battery pack, installation of Sea-Bird software, and testing power and communications are discussed.

## Battery Pack Installation

**WARNING!**  
Do not ship the HydroCAT with battery pack installed. See *Shipping Precautions* in *Section 1: Introduction*.

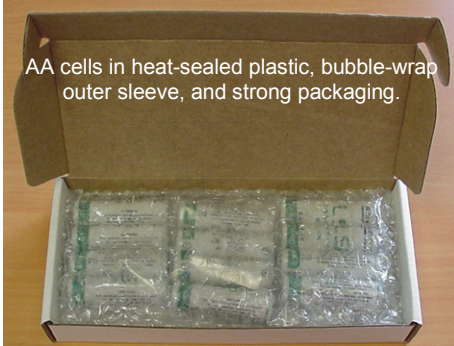

**CAUTION:**  
See *Section 5: Routine Maintenance and Calibration* for handling instructions for the plastic housing.

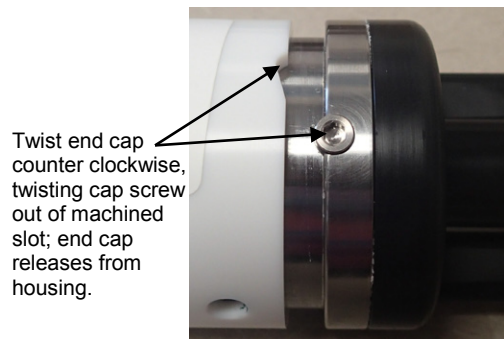
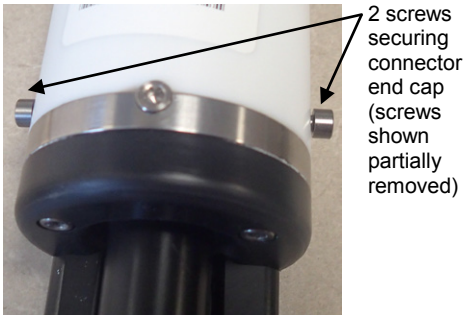

## Description of Cells and Battery Pack

Sea-Bird supplies twelve 3.6-volt AA lithium cells, shipped with the HydroCAT in a heat-sealed plastic bag placed in bubble wrap and a cardboard box. The empty cell holder is installed inside the HydroCAT for shipment.

No soldering is required when assembling the battery pack.

## Installing Cells and Battery Pack

1. Remove the connector end cap:
  - A. Wipe the outside of the end cap and housing dry, being careful to remove any water at the seam between them.
  - B. Remove the 2 cap screws on the sides of the housing. Do not remove any other screws.  
Note: Sea-Bird ships the HydroCAT with a 9/64-inch Allen wrench for these screws.
  - C. Remove the I/O end cap by twisting the end cap counter clockwise; the end cap will release from the housing. Pull the end cap out.
  - D. The end cap is electrically connected to the electronics with a Molex connector. Holding the wire cluster near the connector, pull gently to detach the female end of the connector from the pins.
  - E. Remove any water from the O-ring mating surfaces inside the housing with a lint-free cloth or tissue.
  - F. Put the end cap aside, being careful to protect the O-rings from damage or contamination.

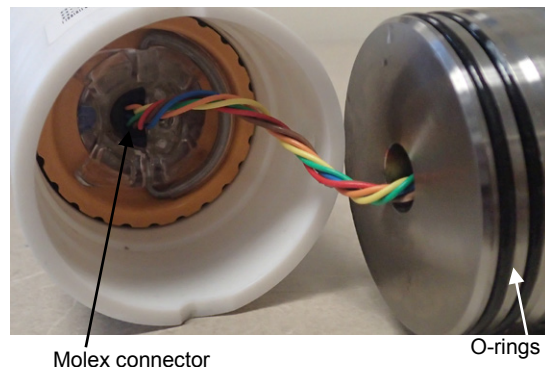

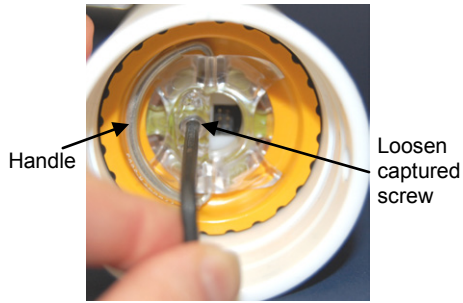

2. Remove the battery pack assembly from the housing:
  - A. Loosen the captured screw from the battery pack cover plate, using the 7/64-inch Allen wrench included with the shipment.
  - B. Lift the battery pack assembly straight out of the housing, using the handle.

3. Keep the handle in an upright position. Holding the edge of the yellow cover plate, unscrew the cover plate from the battery pack assembly.

4. Roll the 2 O-rings on the outside of the battery pack out of their grooves.

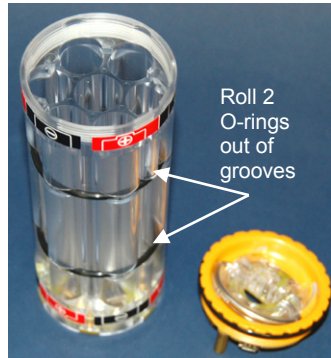

5. Insert each cell into the pack, **alternating** positive (+) end first and negative (-) end first to match the labels on the pack.

6. Roll the 2 O-rings on the outside of the battery pack into place in the grooves. The O-rings compress the side of the battery pack and hold the cells tightly in place in the pack.

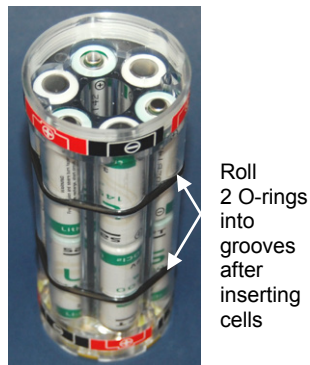

7. Reinstall the battery pack cover plate:
  - A. Align the pin on the battery cover plate PCB with the post hole in the battery pack housing.
  - B. Place the handle in an upright position. Screw the yellow cover plate onto the battery pack assembly. Ensure the cover is tightly screwed on to provide a reliable electrical contact.

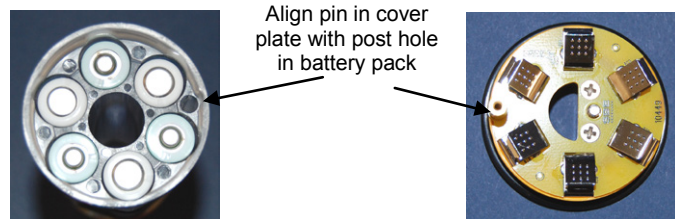

8. Replace the battery pack assembly in the housing:
  - A. Align the D-shaped opening in the cover plate with the pins on the shaft. Lower the assembly slowly into the housing, and once aligned, push gently to mate the banana plugs on the battery compartment bulkhead with the lower PCB. A post at the bottom of the battery compartment mates with a hole in the battery pack's lower PCB to prevent improper alignment.
  - B. Secure the assembly to the shaft with the captured screw, using the 7/64-inch Allen wrench. Ensure the screw is tight to provide a reliable electrical contact.

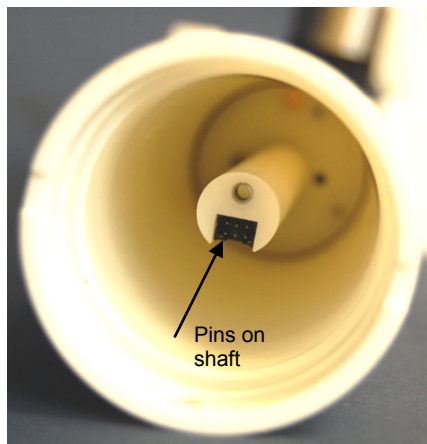

9. Reinstall the connector end cap:
  - A. Remove any water from the O-rings and mating surfaces in the housing with a lint-free cloth or tissue. Inspect the O-rings and mating surfaces for dirt, nicks, and cuts. Clean as necessary. Apply a light coat of O-ring lubricant (Parker Super O Lube) to the O-rings and mating surfaces.
  - B. Plug the female end of the Molex connector onto the pins.
  - C. Carefully fit the end cap into the housing until the O-rings are fully seated.
  - D. Reinstall the 2 cap screws to secure the end cap.

**CAUTION:**  
Do not use Parker O-Lube, which is petroleum based; use only Super O-Lube.

## Software Installation

### Notes:

- Help files provide detailed information on the software.
- It is possible to communicate with the HydroCAT without the referenced software by sending direct commands from a dumb terminal or terminal emulator, such as Windows HyperTerminal.
- Sea-Bird supplies the current version of our software when you purchase an instrument. As software revisions occur, we post the revised software. See our website ([www.sea-birdcoastal.com](http://www.sea-birdcoastal.com)) for the latest software version number, a description of the software changes, and instructions for downloading the software.

Sea-Bird software was designed to work with a PC running Windows XP service pack 2 or later, Windows Vista, or Windows 7 (32-bit or 64-bit).

Two software packages were included on the CD that shipped with your HydroCAT:

- **Seasoft V2** – Program with many components, including a Deployment Endurance Calculator for determining deployment length based on user-input deployment scheme, instrument power requirements, and battery pack capacity.  
To install: Double click on **SeasoftV2.exe**. Follow the dialog box directions to install the software. The installation program allows you to install the desired components. Install all the components, or just install Deployment Endurance Calculator (battery endurance calculator). The default location for the software is c:\Program Files\Sea-Bird. Within that folder is a sub-directory for each program.
- **Universal Coastal Interface (UCI)** – Program designed to set up the HydroCAT, run validation checks, upload data, and plot data. The UCI manual covers installation and use of this software in detail.

## Power and Communications Test

The power and communications test will verify that the system works, prior to deployment.

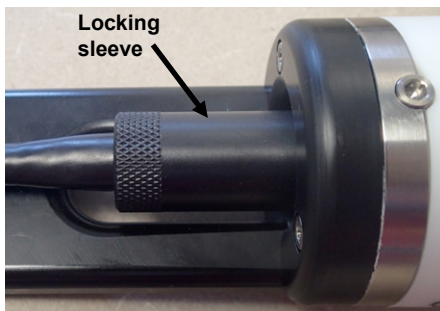
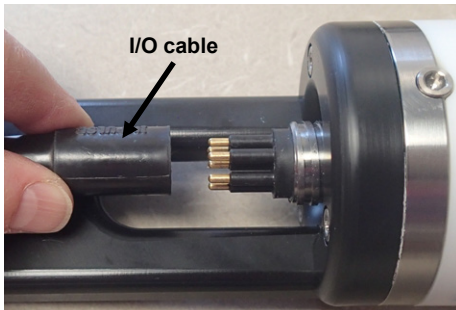

### Test Setup

1. Remove dummy plug (if applicable):
  - A. By hand, unscrew the locking sleeve from the HydroCAT's bulkhead connector. If you must use a wrench or pliers, be careful not to loosen the bulkhead connector instead of the locking sleeve.
  - B. Remove the dummy plug from the HydroCAT's I/O bulkhead connector by pulling the plug firmly away from the connector.
2. Install the I/O cable connector, aligning the pins.
3. Connect the I/O cable to your computer's serial port.



**Note:**

See UCI's Help files.

**Notes:**

- The **Default** button in the HydroCAT Settings dialog sets the units and output parameters to those typical for coastal applications: output temperature (°C), pressure (dbar), specific conductivity (µS/cm), and oxygen (mg/L) (disable other outputs).
- If the minimum conductivity frequency is too close to the *zero conductivity frequency* (from the HydroCAT Calibration Sheet), the pump may turn on when the HydroCAT is in air, as a result of small drifts in the electronics. Some experimentation may be required to control the pump, particularly in fresh water applications.

**Note:**

The HydroCAT automatically enters quiescent (sleep) state after 2 minutes without receiving a command. This timeout algorithm is designed to conserve battery pack energy.

**Test**

1. Open the UCI software.
2. On the UCI Dashboard, click **Connect**.
3. In the Connect dialog box: select HydroCAT as the Instrument Type, enter the baud rate (default 19200). Click *Try All Baud Rates*; UCI will cycle through all available baud rates if it cannot connect at the entered baud rate. Select the COM port. Click **Connect**. On the HydroCAT Dashboard, the Connection Mode shows **Transition** on a yellow background, and then shows **Setup** on a green background when the connection is established.
4. On the HydroCAT Dashboard, click **HydroCAT Settings**. In the HydroCAT Settings dialog box, make the desired selections on each tab:
  - **Output Format** - Parameters to be output and output units (unit selection for Conductivity also applies to Specific Conductivity). All data (conductivity, temperature, pressure, oxygen, time) is stored in the HydroCAT memory in raw format, regardless of selections made here; these selections just affect the data output format for real-time or uploaded data.
  - **Data** - (for autonomous sampling) Interval between samples (sec) and whether to transmit data in real-time (data is always stored in memory).
  - **Pumping** - Minimum conductivity frequency (Hz) to enable pump turn-on, to prevent pump from running before the HydroCAT is in water. Pump does not run when conductivity frequency drops below this value. The HydroCAT Calibration Sheet lists the uncorrected (raw) frequency output at 0 conductivity.  
A typical Minimum Conductivity Frequency value (and factory-set default) for salt water and estuarine applications is (zero conductivity frequency + 500 Hz).  
A typical Minimum Conductivity Frequency value for fresh water applications is (zero conductivity frequency + 5 Hz).
  - **Telemetry** - Baud rate. UCI will automatically reconnect at this baud rate when you click **Upload**.

To save any new settings, click **Upload** when you are done.
5. Click **Start**; the Connection Mode shows **Acquisition** on a green background. The HydroCAT will start logging data at the sample interval specified in the HydroCAT Settings dialog. The real-time data appears in the Real Time Display, in the Time Series plot, and in the Output – Instrument Console. These numbers should be reasonable; i.e., room temperature, zero conductivity, barometric pressure (gauge pressure), current date and time (shipped from the factory set to Pacific Daylight or Standard Time).

The HydroCAT is ready for programming and deployment.

# Section 4:

## Deploying and Operating HydroCAT

This section includes:

- system operation with example setups
- baud rate and cable length considerations
- timeout description
- data output formats
- optimizing data quality
- deploying and recovering the HydroCAT
- uploading and processing data from the HydroCAT's memory

---

### Sampling Modes

The HydroCAT has two basic sampling modes for obtaining data:

- Polled Sampling – On command, the HydroCAT runs the pump, takes one sample, and transmits data.
- Autonomous Sampling – At pre-programmed intervals, the HydroCAT wakes up, runs the pump, samples, stores data in memory, and goes to sleep. Data can be transmitted real-time (set real-time output in HydroCAT Settings dialog box).

Output parameters and units can be used in various combinations to provide a high degree of operating flexibility.

#### Notes:

- The pump runs only if the conductivity frequency from the last sample was greater than the minimum conductivity frequency for running the pump (set in the HydroCAT Settings dialog box). Checking the conductivity frequency prevents the pump from running in air for long periods of time, which could damage the pump.
- Autonomous sampling is not compatible with SDI-12 operation.

The integral pump runs before every sample measurement. The pump flushes the previously sampled water from the conductivity cell and oxygen plenum and brings a new water sample quickly into the system. Water does not freely flow through the plumbing between samples, minimizing fouling. See *Pump Operation* in *Section 2: Description of HydroCAT* for details.

- HydroCAT without Dissolved Oxygen sensor – Pump runs for 1.0 second before each measurement.
- HydroCAT with Dissolved Oxygen sensor -For Adaptive Pump Control, pumping time is dependent on the temperature and pressure of the previous sample, as described in *Pump Operation* in *Section 2: Description of HydroCAT*.

Descriptions and examples of the sampling modes follow. Review the operation of the basic sampling modes before setting up your system.

## Polled Sampling

On command, the HydroCAT takes a measurement and sends the data to the computer. Storing of data in the HydroCAT's FLASH memory is dependent on the particular command used. Polled sampling commands can be sent in two ways:

- Via RS-232 in a terminal program – see *Appendix III: Command Summary and Details* for a list of commands and descriptions. Note that many of the commands listed in the *Appendix* can be more easily sent via the UCI.
- Via SDI-12 – see *Command Descriptions and Data Output Format – Transmission via SDI-12* in this section.

For polled sampling commands that run the pump, the HydroCAT checks if the conductivity frequency from the last sample was greater than the Minimum Conductivity Frequency before running the pump.

### *Example: Polled Sampling using SDI-12 Interface*

Connect to HydroCAT via UCI. Set up to include temperature (°C), specific conductivity (µS/cm), pressure (psi), and oxygen (mg/L) with data, set the SDI-12 address for this HydroCAT, and set it to operate in Polled Sampling mode.

1. Click **Connect** in UCI. In dialog box, select HydroCAT, baud rate, and Port, and click Try All Baud Rates. Click **Connect**. Connection Mode shows **Transition** and then shows **Setup**.
2. Click **HydroCAT Settings**:
  - A. On Output Format tab, select the desired output parameters and units (note that units for Conductivity also apply to Specific Conductivity).
  - B. On Pumping tab, verify that Minimum Conductivity Frequency is appropriate for your application.
  - C. Click **Upload** to send settings to HydroCAT.
3. Click **Command Terminal**.
  - A. In the Terminal Window, type **SetAddress=x** (where **x** is address [0-9, a-z, A-Z] for SDI-12 communications), and click **Submit**.
  - B. In the Terminal Window, select Get Configuration Data (**GetCD**) and click **Submit** to verify setup.
  - C. In the Terminal Window, select Get Calibration Coefficients (**GetCC**) and click **Submit** to verify setup.
  - D. Close the Terminal Window.
4. Click **Deploy HydroCAT**.
  - A. In Step 1, select Polled Sampling (SDI-12).
  - B. In Step 3, select Synchronize HydroCAT clock to computer to update the clock. If you previously uploaded any data in memory, select Clear HydroCAT data to make the full memory available for recording.
  - C. In Step 4, enter the desired file name and location for the Deployment Report.
  - D. Click **Finish**. UCI automatically disconnects from the HydroCAT.

When ready to take a sample (repeat as desired): connect to HydroCAT via SDI-12, command it to take a sample and store data in memory, and command it to output data.

Break

aM! (where 'a' is SDI-12 address)

aD0! (where 'a' is SDI-12 address)

(wake all HydroCATs on line)

(take sample; store data in memory and in buffer)

(send data from HydroCAT buffer)

## Autonomous Sampling (Logging commands)

At pre-programmed intervals the HydroCAT wakes up, runs the pump (if the conductivity frequency from the last sample was greater than the Minimum Conductivity Frequency), samples data, stores the data in its FLASH memory, and goes to sleep (enters quiescent state). Transmission of real-time data to the computer is dependent on the Transmit Real Time setting.

### Notes:

- Autonomous sampling is not compatible with SDI-12 operation.
- If the FLASH memory is filled to capacity, sampling continues, but excess data is not saved in memory (i.e., the HydroCAT does not overwrite the data in memory).

**If transmitting real-time data, keep the signal line open circuit or within  $\pm 0.3$  V relative to ground to minimize power consumption when not trying to send commands.**

### Example: Autonomous Sampling

Connect to HydroCAT via UCI. Set up to include temperature ( $^{\circ}\text{C}$ ), specific conductivity ( $\mu\text{S}/\text{cm}$ ), pressure (psi), and oxygen (mg/L) with data, and set it to operate in Autonomous Sampling mode.

1. Click **Connect** in UCI. In dialog box, select HydroCAT, baud rate, and Port, and click Try All Baud Rates. Click **Connect**. Connection Mode shows **Transition** and then shows **Setup**.
2. Click **HydroCAT Settings**:
  - A. On Output Format tab, select the desired output parameters and units (note that units for Conductivity also apply to Specific Conductivity).
  - B. On Data tab, set the desired sample interval and (if desired) click Transmit Real Time.
  - C. On Pumping tab, verify that Minimum Conductivity Frequency is appropriate for your application.
  - D. On Baud Rate tab, (if desired) change the baud rate to be used for the deployment.
  - E. Click **Upload** to send settings to HydroCAT.
3. Click **Command Terminal**.
  - A. In the Terminal Window, select Get Configuration Data (**GetCD**) and click **Submit** to verify setup.
  - B. In the Terminal Window, select Get Calibration Coefficients (**GetCC**) and click **Submit** to verify setup.
  - C. Close the Terminal Window.
4. Click **Start**. You will see the real time data in UCI's Real Time Display as well as in the Output – Instrument Console. Click **Stop**. If the data looks correct, you are ready to deploy the HydroCAT.
5. Click **Deploy HydroCAT**.
  - A. In Step 1, select Autonomous Sampling.
  - B. In Step 2, select the date and time to start sampling data. If desired, change the Sample Interval (which you set in the HydroCAT Settings dialog).
  - C. In Step 3, select Synchronize HydroCAT clock to computer to update the clock. If you previously uploaded any data in memory, select Clear HydroCAT data to make the full memory available for recording.
  - D. In Step 4, enter the desired file name and location for the Deployment Report.
  - E. Click **Finish**. UCI automatically disconnects from the HydroCAT.

HydroCAT will automatically wake up and go to sleep for each sample. Note that you cannot view real-time data in UCI (because UCI will automatically stop the logging when you reconnect). However, if desired, you can view real-time data in a terminal program if you set it to output real-time data in HydroCAT Settings dialog.

## RS-232 Real-Time Data Acquisition

### Notes:

- RS-232 baud rate is set on the Baud Rate tab of the HydroCAT Settings dialog.
- If using external power, see *External Power* in *Section 2: Description of HydroCAT* for power limitations on cable length.

The length of cable that the HydroCAT can drive when communicating via **RS-232** is dependent on the baud rate. The allowable combinations are:

Maximum Cable Length (meters)	Maximum Baud Rate
200	4800
100	9600
50	19200
25	38400
16	57600
8	115200

Check the capability of your computer and terminal program before increasing the baud; high baud requires a short cable and good PC serial port with an accurate clock.

---

## Timeout Description

The HydroCAT has a timeout algorithm. If the HydroCAT does not receive a command for 2 minutes, it powers down its communication circuits to prevent exhaustion of the battery pack. This places the HydroCAT in quiescent state, drawing minimal current.

---

## Command Descriptions – Transmission via RS-232

UCI software is used to easily communicate with and set up the HydroCAT, and upload and plot data. See *Appendix III: RS-232 Command Summary and Details* for customers who want access to the full list of commands that can be sent to the HydroCAT via a terminal program.

## Command Descriptions and Data Output Format – Transmission via SDI-12

**Note:**

See *Appendix III: RS-232 Command Summary and Details* for descriptions of RS-232 commands that are referenced in this section.

**All SDI-12 commands:**

- Are case sensitive.
- Are terminated with ‘!’ (except as noted).
- Start with the SDI-12 address, designated as ‘a’ in the command descriptions below (0-9, a-z, A-Z).

**All SDI-12 command responses:**

- Are terminated with <CR><LF> (except as noted).

### SDI-12 Standard Commands

**Break**

Command	Response	Description
Break	None; initiate search for valid mark.	12 millisecc spacing on line - Wake all HydroCATs on line. <i>Note:</i> ‘!’ command termination and <CR><LF> do not apply.

**Acknowledge Active**

Command	Response	Description
a!	a <CR><LF>	Check that HydroCAT ‘a’ is responding.

**Note:**

The serial number is the last 5 digits of the serial number on the HydroCAT’s label (for example, 03732345 on the label appears as 32345 in the a!! response).

**Send Identification**

Command	Response	Description
a!!	Allccccccmmmmmmvvnvvnnnn ooooooo<CR><LF> <i>where</i> ll = SDI-12 version compatibility (13 = 1.3) ccccccc = vendor ID (‘SeaBird ’) mmmmmm = Instrument ID (‘HCAT ’) vvv = HydroCAT firmware version (‘213’) nnnnn = HydroCAT serial number ooooooo= up to 8 characters, designation of optional sensors (P if pressure installed, O if Oxygen installed) <i>Example string when HydroCAT’s SDI-12 address is 0, serial number is HC-32345 and pressure and oxygen sensors installed:</i> 013SeaBird HCAT 21332345PO	Identify instrument. <i>Notes:</i> <ul style="list-style-type: none"> <li>• Serial number is last 5 characters of serial number.</li> <li>• Firmware version in a!! response is limited to number of digits shown. Use aXV! (see SDI-12 Extended Commands) to get full firmware version. For example, for firmware version 2.13.0, a!! will return ‘213’ (sending 2 digits for the number after the first decimal point), while aXV! will return ‘2.13.0’.</li> </ul>

**SDI-12 Address Query**

Command	Response	Description
?!	a<CR><LF>	Get HydroCAT’s SDI-12 address; valid only if just 1 HydroCAT online.

**Change SDI-12 Address**

Command	Response	Description
aAb!	b<CR><LF>	Change HydroCAT’s SDI-12 address from ‘a’ to ‘b’.

**Note:**

Responses to Start Measurement commands include:

- a = SDI-12 address
- ttt = maximum amount of time (sec) until data is ready
- n (1 digit, for M commands) **or** nn (2 digits, for C [Concurrent] commands) = number of parameters in data string (can include T, C, P, salinity, sound velocity, specific conductivity, sample number; dependent on which outputs are enabled)

**Start Measurement TPSS** (run pump; store data in HydroCAT FLASH memory)

Command	Response	Description
aM!	atttn<CR><LF> <i>(followed by)</i> a<CR><LF> <i>(when data is ready)</i>	Send <b>TPSS</b> to HydroCAT (run pump, take sample, store data in buffer, store data in FLASH memory for later upload). Hold results in HydroCAT buffer until another sample taken. Service request issued when data ready.
aMC!	Same as aM!	Same as aM!, but response in buffer includes 3-character checksum before <CR><LF>.
aC!	atttnn<CR><LF>	Same as aM!, but service request (a<CF><LF>) not sent.
aCC!	Same as aC!	Same as aC!, but response in buffer includes 3-character checksum before <CR><LF>.

**Start Measurement TPS** (run pump; do **not** store data in FLASH memory)

Command	Response	Description
aM1!	atttn<CR><LF> <i>(followed by)</i> a<CR><LF> <i>(when data is ready)</i>	Send <b>TPS</b> to HydroCAT (run pump, take sample, store data in buffer). Hold results in HydroCAT buffer until another sample taken. Service request issued when data ready.
aMC1!	Same as aM1!	Same as aM1!, but response in buffer includes 3-character checksum before <CR><LF>.
aC1!	atttnn<CR><LF>	Same as aM1!, but service request (a<CF><LF>) not sent.
aCC1!	Same as aC1!	Same as aC1!, but response in buffer includes 3-character checksum before <CR><LF>.

**Start Measurement TS** (do **not** run pump or store data in FLASH memory)

Command	Response	Description
aM2!	atttn<CR><LF> <i>(followed by)</i> a<CR><LF> <i>(when data is ready)</i>	Send <b>TS</b> to HydroCAT ( <b>do not run pump</b> ; take sample, store data in buffer). Hold results in HydroCAT buffer until another sample taken. Service request issued when data ready.
aMC2!	Same as aM2!	Same as aM2!, but response in buffer includes 3-character checksum before <CR><LF>.
aC2!	atttnn<CR><LF>	Same as aM2!, but service request (a<CF><LF>) not sent.
aCC2!	Same as aC2!	Same as aC2!, but response in buffer includes 3-character checksum before <CR><LF>.

**Send Data**

Command	Response	Description
aD0!	a<values><CRC><CR><LF> <i>where</i> <values> = parameters in data string (can include T, C, P, salinity, sound velocity, specific conductivity, sample number; dependent on which outputs are enabled) CRC is sent if Start Measurement command included CRC request (aMC!, aMC1!, aCC!, aCC1!, etc.)	Send data from HydroCAT buffer. If string is too long, additional commands (aD1!, aD2!, etc.) required to retrieve remaining data. Number of characters in values plus CRC string is limited to 75 for Concurrent data (sampling command string includes 'C'), or 35 for non-Concurrent data (sampling command string includes 'M').

## SDI-12 Extended Commands

The following commands, defined by an 'X', make it possible to perform common setup changes in the field without connecting to a computer:

Command	Response	Description
aXV!	av.v.v, mmm dd yyyy hh:mm:ss <CR><LF> <i>where</i> v.v.v = firmware version (2.13.0) mm dd yyyy = firmware date hh:mm:ss = firmware time	Get full HydroCAT firmware version string (firmware version and firmware date).
aXPx!	ax<CR><LF>	Send <b>PumpOn (1)</b> or <b>PumpOff (0)</b> . Turn pump on to test or remove sediment; <b>runs continuously, drawing current.</b>
aXMCFx!	ax<CR><LF>	Send <b>MinCondFreq=x</b> . Minimum conductivity frequency (Hz) to enable pump turn-on, to prevent pump from running in air. Configuration Sheet lists frequency output at 0 conductivity. Typical <b>MinCondFreq</b> values: salt water & estuarine: (0 conductivity frequency + 500). fresh water: (0 conductivity frequency + 5).
aXMRx!	xx<CR><LF> <i>where</i> x = current sample number  Note: must send aXMR0! twice. Response to first command shows current sample number. Response to second command shows that current sample number has been reset to 0 (memory has been reset).	Send <b>InitLogging</b> when <b>x=0</b> . <b>After all data has been uploaded</b> , initialize logging to make entire memory available for recording. If not initialized, data is stored after last recorded sample. HydroCAT requires command to be sent twice, to prevent accidental reset of memory.
aXUTx!	ax<CR><LF>	Send <b>SetTempUnits=x</b> . <b>x=0</b> : Temperature °C, ITS-90. <b>x=1</b> : °F, ITS-90.
aXUCx!	ax<CR><LF>	Send <b>SetCondUnits=x</b> . <b>x=0</b> : Conductivity S/m. <b>x=1</b> : mS/cm. <b>x=2</b> : µS/cm.
aXUPx!	ax<CR><LF>	Send <b>SetPressUnits=x</b> . <b>x=0</b> : Pressure decibars. <b>x=1</b> : psi (gauge).
aXUOx!	ax<CR><LF>	Send <b>SetOxUnits=x</b> . <b>x=0</b> : Oxygen ml/L. <b>x=1</b> : mg/L.
aXOxxxxxxx!	axxxxxxxx<CR><LF> <i>where</i> xxxxxxx=enable (1)/disable (0) status for each output parameter (in order: temperature, conductivity, pressure, oxygen, salinity, sound velocity, specific conductivity, sample number)  <i>Example (enable T, C, P, DO, salinity):</i> a11111000 <i>Example (enable T, C, salinity; no pressure installed):</i> a11011000	Send <b>OutputTemp=x</b> , <b>OutputCond=x</b> , <b>OutputPress=x</b> , <b>OutputSal=x</b> , <b>OutputSV=x</b> , <b>OutputSC=x</b> , <b>TxSampleNum=x</b> .  <b>x=0</b> : Disable output. <b>x=1</b> : Enable output.

**Note:**

For all extended commands with an argument (x): If the argument is omitted, the response provides the current setting.

**Note:**

If the HydroCAT does not have a pressure sensor and/or oxygen sensor:

- The enable/disable character for that parameter has no effect on the output, but must be included in the string.
- HydroCAT returns an 'x' for the current output setting for that parameter.



## SDI-12 Data Format

The **identification string** (a!) for SDI-12 is:

A<ll><Vendor ID><Model Number><Firmware version><Serial Number><Optional Sensors>

where

- a = SDI=12 address
- ll = SDI-12 version compatibility (13 = 1.3)
- Vendor ID = 8 characters (‘SeaBird’ for Sea-Bird instruments)
- Model number = 6 characters (‘HCAT’ for this HydroCAT)
- Firmware version = 3 characters (vvv); use aXV! to get the full firmware version (for example, for firmware 2.13.0, a! shows the firmware as 213, while aXV! shows the firmware as 2.13.0)
- Serial number = last 5 characters of HydroCAT serial number (nnnnn)
- Optional Sensors = up to 8 characters
  - P = pressure sensor installed
  - O = dissolved oxygen sensor installed

*additional characters available for future products*

*Example:* Identification string for HydroCAT with SDI-12 address 0, when HydroCAT’s serial number is HCAT32345 and **pressure and oxygen sensors installed:**

013SeaBird HCAT 21332345PO

### Notes:

- In UCI, click **HydroCAT Settings** to set data output units and enable output of desired parameters.
- HydroCAT automatically outputs in this format over the SDI-12 line. If viewing data via an RS-232 terminal program, set **OutputFormat=3** to emulate this data format.
- The HydroCAT’s pressure sensor is an absolute sensor, so its **raw** output (**OutputFormat=0**) includes the effect of atmospheric pressure (14.7 psi). As shown on the Calibration Sheet, Sea-Bird’s calibration (and resulting calibration coefficients) is in terms of psia. However, when outputting pressure in **psi** or **decibars**, the HydroCAT outputs pressure relative to the ocean surface (i.e., at the surface the output pressure is 0 psi or 0 dbar). The HydroCAT uses the following equations to convert psia:
  - $P(\text{psi}) = P(\text{psia}) - 14.7$
  - $P(\text{dbar}) = [P(\text{psia}) - 14.7] * 0.689476$

The **converted decimal data format** for SDI-12 is:

a+ttt.tttt+c+ppp.pppp+oo.ooo+sss.ssss+vvvv.vvv+x+n

where

- a = SDI=12 address
- (+ or -) sign precedes each parameter
- ttt.tttt = temperature; sent if temperature output enabled; units °C or °F.
- c = conductivity; sent if conductivity output enabled.
  - cc.ccccc if conductivity units set to S/m.
  - ccc.cccc if conductivity units set to mS/cm.
  - cccc.c if conductivity units set to µS/cm.
- pppp.ppp = pressure; sent if optional pressure sensor installed and pressure output enabled; units dbar or psi.
- oo.ooo = oxygen; sent if optional oxygen sensor installed and oxygen output enabled; units ml/L or mg/L.
- sss.ssss = salinity (psu); sent if salinity enabled.
- vvvv.vvv = sound velocity (m/sec); sent if sound velocity output enabled.
- x = specific conductivity; sent if specific conductivity output enabled.
  - xx.xxxxx if conductivity units set to S/m.
  - xxx.xxxx if conductivity units set to mS/cm.
  - xxxxxx.x if conductivity units set to µS/cm.
- n = sample number in FLASH memory; sent if sample number output enabled, and using polled sampling command that stores data in FLASH memory.

Note the following:

- Polarity sign is always sent.
- Decimal point is optional.
- Maximum digits for a value is 7, even without a decimal point.
- Minimum digits for a value is 1.
- Maximum characters in data value is 9 (sign, 7 digits, decimal point).
- Leading zeros are suppressed, except for one zero to left of decimal point.

*Example:* Sample data output when pressure and oxygen sensors installed, aXUT0!, aXUC0!, aXUP0!, and aXO1111111! (outputting all parameters):

0+23.6261+0.00002-0.267+0.838+0.0115+1492.967+0.00002+1

(SDI-12 address, temperature, conductivity, pressure, oxygen, salinity, sound velocity, specific conductivity, sample number)

## RS-232 Data Formats

### Notes:

- You can set the desired RS-232 output format (**OutputFormat=**) in an RS-232 terminal program.
- In UCI, click **HydroCAT Settings** to set data output units and enable output of desired parameters (or see *Appendix III* for the commands to send via an RS-232 terminal program).
- Time is the time at the **start** of the sample.
- When real-time output is enabled, real-time autonomous data transmitted via **RS-232** is preceded by a # sign.
- The HydroCAT's pressure sensor is an absolute sensor, so its **raw** output (**OutputFormat=0**) includes the effect of atmospheric pressure (14.7 psi). As shown on the Calibration Sheet, Sea-Bird's calibration (and resulting calibration coefficients) is in terms of psia. However, when outputting pressure in **psi** or **decibars**, the HydroCAT outputs pressure relative to the ocean surface (i.e., at the surface the output pressure is 0 psi or 0 dbar). The HydroCAT uses the following equations to convert psia:  

$$P(\text{psi}) = P(\text{psia}) - 14.7$$

$$P(\text{dbar}) = [P(\text{psia}) - 14.7] * 0.689476$$

Defined below are the HydroCAT's RS-232 output data formats. Each scan ends with a carriage return <CR> and line feed <LF>.

- **OutputFormat=0**: raw decimal data, for diagnostic use at Sea-Bird  
 HCAT037xxxxx,ttttt, ccccc.ccc, pppppp, vvvv, oo.ooo, t.ttttt,  
 dd mmm yyyy, hh:mm:ss

### where

- HCAT037nnnnn = instrument ID (HCAT) and serial number (037nnnnn)
- ttttt = temperature A/D counts.
- ccccc.ccc = conductivity frequency (Hz).
- pppppp = pressure sensor pressure A/D counts; sent if optional pressure sensor installed.
- oo.ooo = oxygen sensor phase (μsec); sent if oxygen sensor installed.
- t.ttttt = oxygen sensor temperature voltage.
- vvvv = pressure sensor pressure temperature compensation A/D counts; sent if optional pressure sensor installed.
- dd mmm yyyy = day, month, year.
- hh:mm:ss = hour, minute, second.

Note that salinity, sound velocity, specific conductivity, and sample number are not sent, regardless of the setting for those parameters. All data is separated with a comma and a space.

*Example:* Sample data output when pressure and oxygen sensors installed and **OutputFormat=0**:

```
HCAT03732345,223474, 2723.945, 578618, 1965, 16.693, 0.686060,  
14 Nov 2015, 08:32:05
```

(instrument ID and serial number, temperature, conductivity, pressure sensor pressure, pressure sensor temperature compensation, oxygen phase, oxygen temperature voltage, date, time)

- **OutputFormat=1:** converted decimal data  
 HCAT037xxxxx,tt.tttt, c, p.ppp, sss.ssss, vvvv.vvv, x, dd mmm yyyy, hh:mm:ss, n

where

- HCAT037nnnnn = instrument ID (HCAT) and serial number (037nnnnn)
- tt.tttt = temperature; sent if temperature output enabled; units °C or °F.
- c = conductivity; sent if conductivity output enabled.  
 c.ccccc if conductivity units set to S/m.  
 cc.cccc if conductivity units set to mS/cm.  
 ccccc.c if conductivity units set to µS/cm.
- p.ppp = pressure; sent if optional pressure sensor installed and pressure output enabled; units dbar or psi.  
 Number of digits to left of decimal place is dependent on pressure sensor range.
- oo.ooo = oxygen; sent if optional oxygen sensor installed and oxygen output enabled; units ml/L or mg/L.
- sss.ssss= salinity (psu); sent if salinity output enabled.
- vvvv.vvv = sound velocity (m/sec); sent if sound velocity enabled.
- x = specific conductivity; sent if specific conductivity output enabled.  
 x.xxxxx if conductivity units set to S/m.  
 xx.xxxx if conductivity units set to mS/cm.  
 xxxxx.x if conductivity units set to µS/cm.
- dd mmm yyyy = day, month, year.
- hh:mm:ss = hour, minute, second.
- n = sample number in FLASH memory; sent if sample number output enabled, and autonomous sampling or using polled sampling commands that store data in FLASH memory or retrieve last sample from FLASH memory.

Leading zeros are suppressed, except for one zero to the left of the decimal point. All data is separated with a comma and at least one space.

*Example:* Sample data output for real-time autonomous data transmitted via RS-232 when pressure and oxygen sensors installed, and outputting all parameters:  
 HCAT03732345, 23.6261, 0.00002, -0.267, 0.838,  
 0.0115, 1492.967, 0.00002, 20 Nov 2015, 12:28:00, 1  
 (instrument ID and serial number, temperature, conductivity, pressure, oxygen, salinity, sound velocity, specific conductivity, date, time, sample number)

**Note:**

- For ease in reading, the data structure is shown with each XML tag on a separate line. However, there are no carriage returns or line feeds between tags (see example below).
- The HydroCAT uses the raw phase delay and raw thermistor voltage from the integrated DO sensor, along with pressure and salinity data from the CTD, to compute and output oxygen in ml/L or mg/L. If the HydroCAT does not include a pressure sensor, it uses the HydroCAT's reference pressure (**ReferencePressure=**) in the pressure correction term of the oxygen equation.

- **OutputFormat=2:** converted decimal data in XML

```
<?xml version="1.0"?>
<datapacket>
<hdr>
<mfg>Sea-Bird</mfg>
<model>HydroCAT-SDI12</model>
<sn>037nnnn</sn>
</hdr>
<data>
<t1>t.t.t.t</t1>
<c1>c</c1>
<p1>p.p.p</p1>
<ox63r>oo.ooo</ox63r>
<sal>sss.ssss</sal>
<sv>vvvv.vvv</sv>
<sc>x</sc>
<smpl>n</smpl>
<dt>yyyy-mm-ddThh:mm:ss</dt>
</data>
</datapacket>
```

*where*

- 037nnnn = HydroCAT serial number
- t.t.t.t = temperature; sent if temperature output enabled; units °C or °F.
- c = conductivity; sent if conductivity output enabled.  
c.ccccc if conductivity units set to S/m.  
cc.cccc if conductivity units set to mS/cm.  
cccc.c if conductivity units set to µS/cm.
- p.p.p.p = pressure (sent if optional pressure sensor installed and pressure output enabled; units dbar or psi).  
Number of digits to left of decimal place is dependent on pressure sensor range.
- oo.ooo = oxygen (sent if optional oxygen sensor installed and oxygen output enabled; units ml/L or mg/L).
- sss.ssss = salinity (psu); sent if salinity output enabled.
- vvvv.vvv = sound velocity (m/sec); sent if sound velocity output enabled.
- x = specific conductivity; sent if specific conductivity output enabled.  
x.xxxxx if conductivity units set to S/m.  
xx.xxxx if conductivity units set to mS/cm.  
xxxxx.x if conductivity units set to µS/cm.
- dd mmm yyyy = day, month, year.
- hh:mm:ss = hour, minute, second.
- n = sample number in FLASH memory; sent if sample number output enabled, and autonomous sampling or using polled sampling commands that store data in FLASH memory or retrieve last sample from FLASH memory.

Leading zeros are suppressed, except for one zero to the left of the decimal point.

*Example:* Sample data output for HydroCAT serial number HC-30033 with real-time autonomous data transmitted via RS-232 when pressure and oxygen sensors installed, and outputting all parameters:

```
<?xml version="1.0"?><datapacket><hdr><mfg>Sea-Bird</mfg><model>HydroCAT-SDI12</model>
<sn>03730033</sn></hdr><data><t1>23.6261</t1><c1>0.00002</c1><p1>-0.267</p1>
<ox63r>0.838</ox63r><sal>0.0115</sal><sv>1492.967</sv><sc>0.00002</sc><smpl>1</smpl>
<dt>2015-11-20T12:28:00</dt></data></datapacket> CRLF
```

(manufacturer, model, serial number, temperature, conductivity, pressure, oxygen, salinity, sound velocity, specific conductivity, sample number, date and time)

**Note:**

- HydroCAT automatically outputs in this format over the SDI-12 line. Setting **OutputFormat=3** allows you to view the SDI-12 data output string while communicating via RS-232.
- The HydroCAT uses the raw phase delay and raw thermistor voltage from the integrated DO sensor, along with pressure and salinity data from the CTD, to compute and output oxygen in ml/L or mg/L. If the HydroCAT does not include a pressure sensor, it uses the HydroCAT's reference pressure (**ReferencePressure=**) in the pressure correction term of the oxygen equation.

- OutputFormat=3**: converted decimal data in SDI-12 format

a+ttt.tttt+c+ppp.pppp+oo.ooo+sss.ssss+vvvv.vvv+x+n

where

- a = SDI-12 address
- (+ or -) sign precedes each parameter
- ttt.tttt = temperature; sent if temperature output enabled; units °C or °F.
- c = conductivity; sent if conductivity output enabled.  
cc.ccccc if conductivity units set to S/m.  
ccc.cccc if conductivity units set to mS/cm.  
cccc.c if conductivity units set to µS/cm.
- pppp.ppp = pressure; sent if optional pressure sensor installed and pressure output enabled; units dbar or psi.
- oo.ooo = oxygen; sent if optional oxygen sensor installed and oxygen output enabled; units ml/L or mg/L.
- sss.ssss = salinity (psu); sent if salinity output enabled.
- vvvv.vvv = sound velocity (m/sec); sent if sound velocity output enabled.
- x = specific conductivity; sent if specific conductivity output enabled.  
xx.xxxxx if conductivity units set to S/m .  
xxx.xxxx if conductivity units set to mS/cm.  
xxxxx.x if conductivity units set to µS/cm.
- n = sample number in FLASH memory; sent if sample number output enabled, and using polled sampling command that stores data in FLASH memory.

Note the following:

- Polarity sign is always sent.
- Decimal point is optional.
- Maximum digits for a value is 7, even without a decimal point.
- Minimum digits for a value is 1.
- Maximum characters in data value is 9 (sign, 7 digits, decimal point).
- Leading zeros are suppressed, except for one zero to left of decimal point.

*Example:* Sample data output when pressure sensor is installed, and outputting all parameters:

0+23.6261+0.00002-0.267+0.838+0.0115+1492.967+0.00002+1

(SDI-12 address, temperature, conductivity, pressure, oxygen, salinity, sound velocity, specific conductivity, sample number)

## Optimizing Data Quality

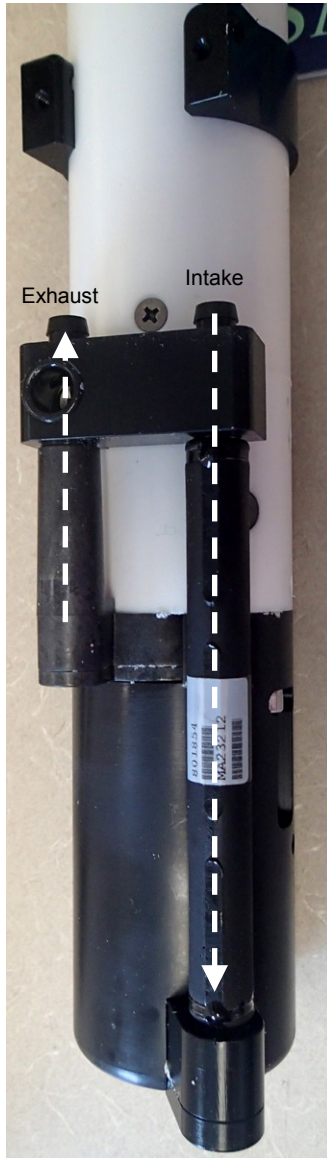

*Preferred orientation - Upright U-Shape; connector end at top (shown with conductivity cell guard and anti-foulant fittings removed)*

### Background Information

The HydroCAT orientation affects the pump operation, impacting data quality. Air must exit the plumbing for the pump to prime and operate. Air most easily exits the plumbing if the HydroCAT is deployed with the plumbing in an upright U-shape (connector end up). In considering the effect of air on the pump, it can be instructive to look at the amount of air in the water column:

- **Case 1:** The top ~2 meters of the water column may contain a continuous supply of bubbles injected into the system by breaking waves. In this area, the ability to continuously eliminate air from the system, throughout the deployment, is of prime concern.
- **Case 2:** The next ~30 meters of the water column is not typically affected by bubbles from breaking waves. It could take a few days to weeks after deployment for the air to clear out of the system in an inverted U-shape (connector end down). However, once the air was bled, no more air would be injected into the plumbing.
- **Case 3:** Below ~30 meters, it could take only a few hours to a day for the air to clear out of the system in an inverted U-shape. As in Case 2, once the air was bled, no more air would be injected into the plumbing.

### Deployment Recommendations

- **Most deployments** – Deploy the HydroCAT with the plumbing in an **upright U-shape** (as shown in the photos; connector end up). This orientation provides optimal bleeding of air from the plumbing, but leaves the HydroCAT vulnerable to ingestion of sediment.
- **When sediment is an issue** –In areas of moderate to high turbidity (> 200 NTU), the ingestion of sediment is an issue when deployed with the plumbing in an upright U-shape (connector end up). A pump clogged with sediment results in poor flushing, causing poor quality data. For these applications, deploy the HydroCAT with the plumbing in an **inverted U-shape** (connector end down).

**If deploying with a cable:** With the HydroCAT intake and exhaust in the water, run the pump for 5 - 15 minutes upon deployment (using **Start Pumping** in UCI). This will help to clear any air from the system. Then flip the HydroCAT into the desired inverted U-shape position, while keeping the intake and exhaust in the water.

**If deploying without a cable:** If you cannot run the pump upon initial deployment, you need to allow time for trapped air to dissolve into the water and the pump to prime properly. This deployment method will provide good data within a day for deployment s deeper than ~30 meters. Eliminate scans associated with the initial deployment by evaluating the conductivity data; minimal changes in conductivity are an indication that pump flow is not correct because air in the plumbing has prevented the pump from priming.

- **When (for mounting reasons) preferred orientation is horizontal** – Sea-Bird does not recommend horizontal mounting, because sediment can accumulate in the conductivity cell, resulting in very poor quality conductivity data. **As a minimum, incline the HydroCAT 10 degrees above the horizontal, with the intake above the exhaust**, to prevent sediment accumulation and provide proper pump operation.

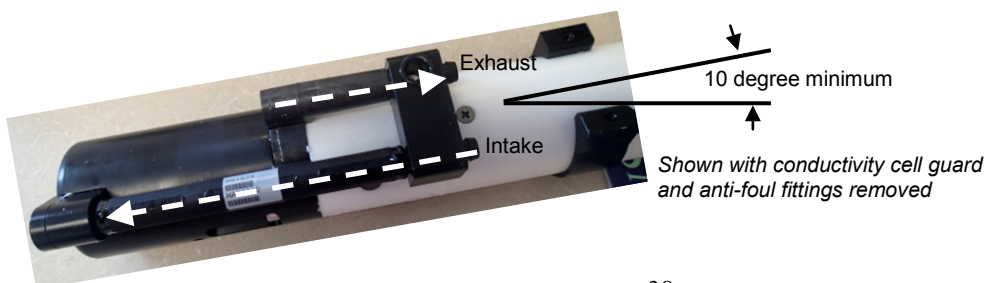

## Setup for Deployment

1. Install new AA lithium cells (see *Section 5: Routine Maintenance and Calibration*) or ensure the existing battery pack has enough capacity to cover the intended deployment.
2. Via **Transfer Data** in UCI, ensure all data has been uploaded (see *Uploading Data* later in this section).
3. (if desired) Via **Temperature Check** in UCI, verify the temperature output stability and accuracy.
4. (if desired) Via **Conductivity Check** in UCI, verify the conductivity output stability and accuracy.
5. Via **HydroCAT Settings** in UCI, establish setup parameters.
6. Via **Command Terminal** in UCI, check status (**GetSD**) and calibration coefficients (**GetCC**) to verify setup.
7. Via **Start** in UCI, start autonomous sampling and view data in the Real Time Display and the Time Series plot to verify setup and operation. Click **Stop** when you are done.
8. For SDI-12 deployments: Program the SDI-12 controller to send periodic requests to run the pump and take a sample (aM!, aMC!, aC!, or aCC! store data in HydroCAT FLASH memory; aM1!, aMC1!, aC1!, or aCC1! do not store data in FLASH memory), and then to transmit the sample (aD0!, aD1!, etc.).
9. Via **Deploy HydroCAT** in UCI:
  - A. Set Operating Mode (Autonomous or Polled Sampling).
    - For Autonomous Sampling, set sample interval and start date and time.
    - For Polled Sampling: set SDI-12 address and bad data flag.
  - B. Set parameters to output and parameter units for real-time data.
  - C. Synchronize time in HydroCAT with computer time, and (if desired) make entire memory available for recording.
  - D. Enter any Deployment notes, and enter/select a file name and location for the Deployment Report.

### Notes on Autonomous Sampling:

- You can program an RS-232 controller to send periodic requests to transmit the last data sample from the HydroCAT memory (**SL**) while sampling autonomously.
- You cannot view real-time autonomous data **in UCI** if you start autonomous sampling via **Deploy HydroCAT**. UCI automatically disconnects from the HydroCAT when you click Finish, and automatically sends a command to stop logging when you reconnect. If desired, you can connect to the HydroCAT with a terminal program to view real-time data.

## Deployment



1. New HydroCATs are shipped with AF24173 Anti-Foulant Devices and a yellow protective label pre-installed.
  - A. Remove the protective label, if installed, from the intake and exhaust. **The label must be removed prior to deployment or pressurization.** If the label is left in place, the flow will be impeded, the sensor will not operate properly, and you may cause severe damage to the conductivity cell.
  - B. Remove the copper anti-foulant assembly and the anti-foulant cap, and verify that the Anti-Foulant Devices are installed (see *Replacing Anti-Foulant Devices – Mechanical Design Change in Section 5: Routine Maintenance and Calibration*). Replace the cap and assembly.

### CAUTIONS:

- Do not use WD-40 or other petroleum-based lubricants, as they will damage the connectors.
- Silicone lubricants in a spray can may contain ketones, esters, ethers, alcohols, or glycols in their propellant. **Do not use these sprays, as they will damage the connector.**

2. Install the dummy plug or I/O cable (for external power and/or communication during deployment):
  - A. Lightly lubricate the inside of the dummy plug or cable connector with silicone grease (DC-4 or equivalent).
  - B. Install the plug/cable connector, aligning the pins.
  - C. Place the locking sleeve over the plug/connector. Tighten the locking sleeve finger tight only. **Do not overtighten the locking sleeve and do not use a wrench or pliers.**



For most applications, deploy in orientation shown (connector end up) for proper operation – see *Optimizing Data Quality*

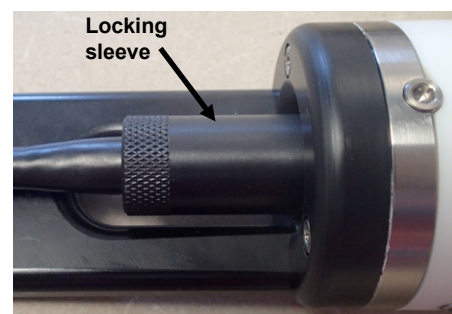
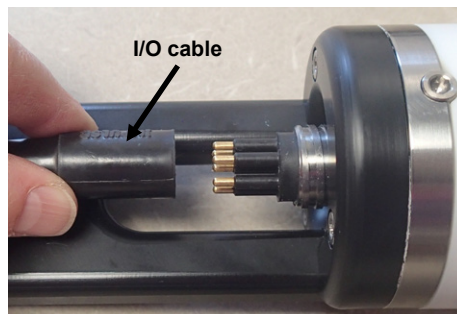

3. Mount the HydroCAT. See *Optimizing Data Quality* for deployment recommendations.
4. Verify that the hardware and external fittings are secure.
5. Deploy the HydroCAT.



## Recovery

### **WARNING!**

**If the HydroCAT stops working while underwater, is unresponsive to commands, or shows other signs of flooding or damage, carefully secure it away from people until you have determined that abnormal internal pressure does not exist or has been relieved.** Pressure housings may flood under pressure due to dirty or damaged o-rings, or other failed seals. When a sealed pressure housing floods at great depths and is subsequently raised to the surface, water may be trapped at the pressure at which it entered the housing, presenting a danger if the housing is opened before relieving the internal pressure. Instances of such flooding are rare. However, a housing that floods at 350 meters depth holds an internal pressure of more than 500 psia, and has the potential to eject the end cap with lethal force. A housing that floods at 50 meters holds an internal pressure of more than 85 psia; this force could still cause injury.

If you suspect the HydroCAT is flooded, point it in a safe direction away from people, and loosen the bulkhead connector very slowly, at least 1 turn. This opens an o-ring seal under the connector. Look for signs of internal pressure (hissing or water leak). If internal pressure is detected, let it bleed off slowly past the connector o-ring. Then, you can safely remove the end cap.

1. Rinse the instrument, conductivity cell, and optional dissolved oxygen sensor with fresh water. (See *Section 5: Routine Maintenance and Calibration* for conductivity cell and oxygen sensor cleaning and storage.)
2. Install a yellow protective label over the intake and exhaust (1 extra label is included in the spares kit that ships with the HydroCAT).



3. If the battery pack is exhausted, new cells must be installed before the data can be extracted. Stored data will not be lost as a result of exhaustion or removal of cells. See Battery Pack Installation in *Section 3: Routine Maintenance and Calibration* for replacement of cells.
4. If immediate redeployment is not required, you can leave the HydroCAT with battery pack in place and in a quiescent state. Because the quiescent current required is small, the battery pack can be left in place without significant loss of capacity.

## Uploading Data

1. Connect to the HydroCAT in the UCI.
2. If desired, increase the HydroCAT's baud rate for data upload: Click **HydroCAT Settings**; select the desired baud rate on the Baud Rate tab in the HydroCAT Settings dialog and click **Upload**.
3. Click **Transfer Data**. The Transfer Data dialog appears:

The screenshot shows the 'Transfer Data' dialog box with the following sections and callouts:

- Data Transfer Options:**
  - Transfer Type:** A dropdown menu set to 'All Data'. Callout: 'Defines data upload type and range: 1. All data– All data is uploaded into 1 file. 2. Scan number range – Enter beginning scan (sample) number and total number of scans. All data within range is uploaded into 1 file.'
  - Block Size (bytes):** A text input field set to '100000'. Callout: 'Select number of bytes uploaded in each block. UCI uploads data in blocks, and calculates a checksum at end of each block. If block fails checksum verification, UCI tries to upload block of data again, cutting block size in half.'
- Memory Summary:**
  - Bytes: 3906
  - Samples: 186
  - Free Samples: 399271
  - Sample Length: 21
- Scan Range:**
  - First Scan Number:** 1
  - Number Scans:** 186
- CSV Format Options:**
  - UTC Time Stamps
  - Local Time Stamps
- Output CSV Data File:**
  - File Name:** HydroCAT-ODO-SDI12\_03730036\_01-04-2015-1346
  - Directory:** C:\MyDocuments
  - Browse:** A button to open a file explorer.

At the bottom of the dialog are three buttons: **Transfer**, **Cancel**, and **Help**.

Make the desired selections and click **Transfer**.

4. The Transfer Progress dialog appears. If desired, click Display Data when Transfer Completed to view the data in the Output-Instrument Console when the upload is done.
5. Ensure all desired data has been uploaded from the HydroCAT by reviewing the data. You can modify the parameters output and /or the units and upload again if desired.

# Section 5: Routine Maintenance and Calibration

This section reviews corrosion precautions, connector mating and maintenance, conductivity cell and oxygen sensor cleaning and storage, pump maintenance, plastic housing handling instructions, replacement of AA cells, O-ring maintenance, pressure sensor maintenance, replacement of AF24173 Anti-Foulant Devices, and sensor calibration. The accuracy of the HydroCAT is sustained by the care and calibration of the sensors and by establishing proper handling practices.

## Corrosion Precautions

Rinse the HydroCAT with fresh water after use and prior to storage.

All exposed metal is titanium; other materials are plastic. No corrosion precautions are required, but direct electrical connection of the HydroCAT housing to mooring or other dissimilar metal hardware should be avoided.

## Connector Mating and Maintenance

### Note:

See *Application Note 57: Connector Care and Cable Installation*.

### CAUTIONS:

- **Do not use WD-40** or other petroleum-based lubricants, as they will damage the connectors.
- **Silicone lubricants in a spray can** may contain ketones, esters, ethers, alcohols, or glycols in their propellant. **Do not use these sprays, as they will damage the connector.**

Clean and inspect the connectors, cable, and dummy plug before every deployment and as part of your yearly equipment maintenance. Inspect connectors that are unmated for signs of corrosion product around the pins, and for cuts, nicks or other flaws that may compromise the seal.

When remating:

1. Lightly lubricate the inside of the dummy plug/cable connector with silicone grease (DC-4 or equivalent).
2. Install the plug/cable connector, aligning the pins.
3. Place the locking sleeve over the plug/cable connector. Tighten the locking sleeve finger tight only. **Do not overtighten the locking sleeve and do not use a wrench or pliers.**

Verify that a cable or dummy plug is installed on the HydroCAT before deployment.

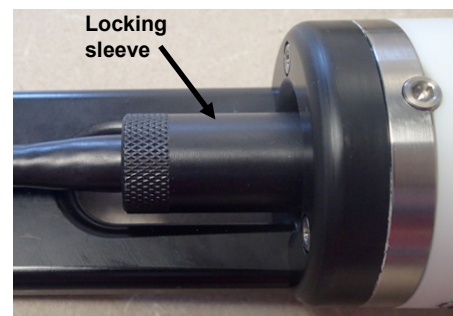
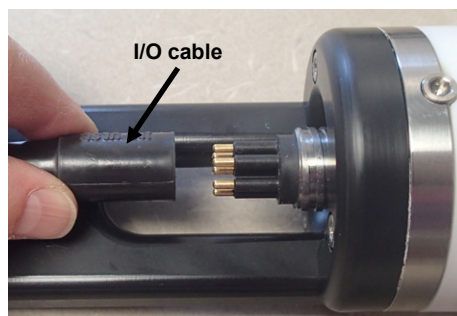

## Conductivity Cell and (optional) Dissolved Oxygen Maintenance

### CAUTIONS:

- **Do not put a brush or any object inside the plumbing to clean it.** Touching and bending conductivity cell electrodes can change the calibration; large bends /movement of the electrodes can damage the cell. Touching or wiping the oxygen sensor window can damage it.
- **Do not store with water in the plumbing.** Freezing temperatures (for example, Arctic environments or during air shipment) can break the conductivity cell or damage the oxygen sensor if it is full of water.

The HydroCAT's conductivity cell, plumbing, and oxygen sensor plenum are shipped dry to prevent freezing in shipping.

**Refer to *Application Note 2D: Instructions for Care and Cleaning of Conductivity Cells* for conductivity cell cleaning procedures and cleaning materials.**

- The Active Use (after each cast) section of the application note is not applicable to the HydroCAT, which is intended for use as a moored instrument.

**Refer to the Hydro-DO manual for cleaning and storage procedures and materials.**

- **Prolonged exposure of the dissolved oxygen sensor optical window to Triton X-100 may be harmful.** Because the conductivity cell and oxygen sensor are integrated in this instrument, we recommend use of the dissolved oxygen sensor cleaning and storage instructions for the entire plumbing system; **do not use cleaning and storage instructions for the conductivity cell (these could damage the oxygen sensor).**

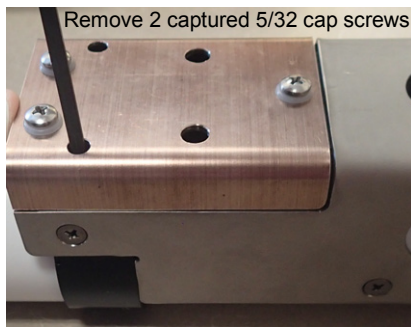

To rinse or fill the conductivity cell, optional dissolved oxygen plenum, pump, and plumbing:

1. Loosen the two captured 5/32" cap screws holding the copper anti-foulant assembly to the housing clamp, using the 5/32-inch Allen wrench included with the shipment. Carefully remove the copper anti-foulant assembly.
2. Hold or clamp the HydroCAT with the connector end up, so that the plumbing is in a U-shape.
3. Pour the water or solution through the plumbing intake with a syringe or wash bottle.
4. Carefully replace the copper guard assembly on the housing. Secure the copper guard assembly to the housing with the two captured cap screws; alternate tightening the screws to secure, maintaining even gaps on the sides.



Push copper anti-foulant assembly while tightening captured cap screws

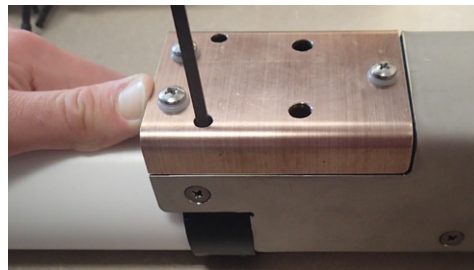

## Pump Maintenance

Sediment in the pump can affect pump operation, impacting data quality. If you suspect the HydroCAT has ingested sediment, put the HydroCAT in clean water and run the pump for 15 minutes (click **Start Pumping** in UCI).

## Handling Instructions



Cap screw securing battery / connector end cap (one each side)

To get excellent performance and longevity for the plastic-housing:

- The HydroCAT's connector end cap is retained by two screws through the side of the housing. The screw holes are close to the end of the housing. Particularly in a cold environment, where plastic is more brittle, the potential for developing a crack around the screw hole(s) is greater for the plastic housing than for a titanium housing. Observe the following precautions –
  - When removing the end cap (to replace the AA cells and/or to access the electronics), be careful to avoid any impact in this area of the housing.
  - When reinstalling the end cap, do not use excess torque on the screws. Sea-Bird recommends tightening the screws to 15 inch-lbs. Alternatively, tighten the screws finger-tight, and then turn each screw an additional 45 degrees.
  
- A plastic housing is more susceptible to scratches than a titanium housing. Do not use screwdrivers or other metal tools to pry off the end cap.
  - Of primary concern are scratches on O-ring mating and sealing surfaces. Take extra precaution to avoid a scraping contact with these surfaces when replacing AA cells and/or re-seating the end cap.
  - Also take care to keep the O-ring lubricated surfaces clean – avoid trapping any sand or fine grit that can scratch the critical sealing surfaces. If the O-ring lubricant does accumulate any material or grit that can cause a leak or make a scratch, it must be carefully cleaned and replaced with fresh, clean lubricant (Parker Super O Lube).
  - Shallow, external scratches are cosmetic only, and will not affect the performance of the HydroCAT. However, deep external scratches can become points of weakness for deep deployments or fracture from impact during very cold weather.
  
- If you remove the screws securing the conductivity cell guard to the housing, follow the same precautions as described above for removing and replacing the connector end cap.

**CAUTION:**  
Do not use Parker O-Lube, which is petroleum based; use only Super O-Lube.

See *Battery Pack Installation* in *Section 3: Preparing HydroCAT for Deployment* and *Appendix II: Electronics Disassembly / Reassembly* for detailed step-by-step procedures for removing the HydroCAT's end caps.

## Replacing AA Cells

### Notes:

- For details and photos, see *Battery Pack Installation* in *Section 3: Preparing HydroCAT for Deployment*.
- Cells must be removed before returning the HydroCAT to Sea-Bird. Do not return used cells to Sea-Bird when shipping the HydroCAT for calibration or repair.

1. Remove the 2 cap screws holding the connector end cap to the HydroCAT housing. Remove the end cap by twisting it counter clockwise; the end cap will release from the housing. Pull the end cap out.
2. Loosen the captured screw holding the battery pack in the housing, and remove the battery pack from the housing.
3. Place the handle in an upright position. Unscrew the yellow cover plate from the top of the battery pack assembly.
4. Roll the 2 O-rings on the outside of the pack out of their grooves.
5. Remove the existing cells. Install new cells, **alternating** positive (+) end first and negative (-) end first to match the labels on the pack.
6. Roll the O-rings into place in the grooves on the side of the battery pack.
7. Place the handle in an upright position. Reinstall the battery pack cover plate.
8. Replace the battery pack assembly in the housing, and secure the assembly with the captured screw. Plug in the Molex connector. Reinstall the HydroCAT end cap, and secure with the 2 cap screws.

## O-Ring Maintenance

### Note:

For details on recommended practices for cleaning, handling, lubricating, and installing O-rings, see the *Basic Maintenance of Sea-Bird Equipment* module in the Sea-Bird Electronics training materials ([www.seabird.com](http://www.seabird.com)).

Recommended inspection and replacement schedule:

- For connector end cap O-rings – inspect each time you open the housing to replace the AA cells; replace approximately once a year.
- For O-rings that are not normally disturbed (for example, on the electronics end cap) - approximately every 3 to 5 years.

Remove any water from the O-rings and mating surfaces in the housing with a lint-free cloth or tissue. Inspect O-rings and mating surfaces for dirt, nicks, and cuts. Clean or replace as necessary. Apply a light coat of O-ring lubricant (Parker Super O Lube) to O-rings and mating surfaces.

### CAUTION:

**Do not use Parker O-Lube, which is petroleum based; use only Super O-Lube.**

## Pressure Sensor (optional) Maintenance

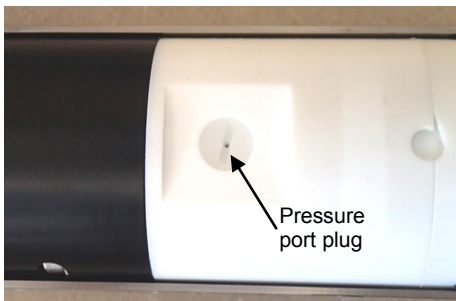

The pressure port plug has a small vent hole to allow hydrostatic pressure to be transmitted to the pressure sensor inside the instrument, while providing protection for the pressure sensor, keeping most particles and debris out of the pressure port.

Periodically (approximately once a year) inspect the pressure port to remove any particles, debris, etc.:

1. Unscrew the pressure port plug from the pressure port.
2. Rinse the pressure port with warm, de-ionized water to remove any particles, debris, etc.
3. Replace the pressure port plug.

### CAUTION:

**Do not put a brush or any object in the pressure port.** Doing so may damage or break the pressure sensor.

## Replacing Anti-Foulant Devices – Mechanical Design Change

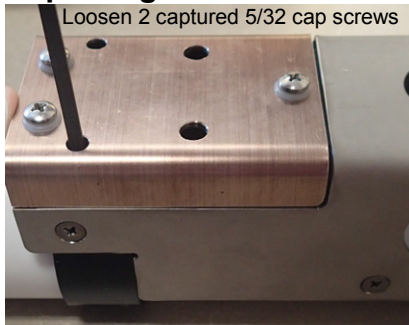

The AF24173 Anti-Foulant Devices are installed at the intake and the pump exhaust. Details are provided below on replacing the AF24173 Anti-Foulant Devices. This page provides the mechanical details for the HydroCAT. The following page, developed for an older Sea-Bird Electronics instrument, provides the precautions and handling details.

1. Loosen the two captured 5/32” cap screws holding the copper anti-foulant assembly to the housing clamp, using the 5/32-inch Allen wrench included with the shipment. Carefully remove the copper anti-foulant assembly.

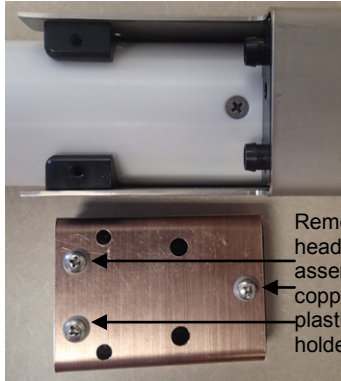

2. Remove the three Phillips-head screws from the copper anti-foulant assembly, and pull the copper guard off.  
*Note: The 5/32” cap screws are not captured once you remove the copper guard.*

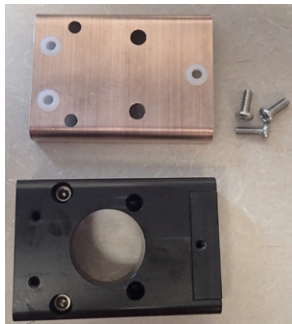

3. Remove the one Phillips-head screw attaching the anti-foulant cap to the anti-foulant holder. Pull the cap off, exposing the AF24173 Anti-Foulant Devices.

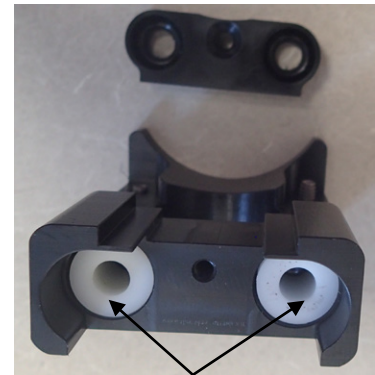

4. Remove and replace the Anti-Foulant Devices.
5. Replace the anti-foulant cap, securing it to the holder with the Phillips-head screw.
6. Place the copper guard on the plastic assembly, and secure with the three Phillips-head screws.
7. Replace the copper anti-foulant assembly on the housing. Secure the copper guard assembly to the housing with the two captured cap screws; alternate tightening the screws to secure, maintaining even gaps on the sides.

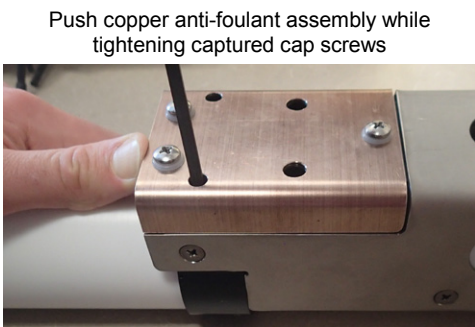

## Replacing Anti-Foulant Devices (SBE 37-SI, SM, IM)



AF24173  
Anti-Foulant  
Device

The HydroCAT has an anti-foulant device cup and cap on each end of the cell. New HydroCATs are shipped with an Anti-Foulant Device and a protective plug pre-installed in each cup.

### **WARNING!**

**AF24173 Anti-Foulant Devices contain bis(tributyltin) oxide. Handle the devices only with rubber or latex gloves. Wear eye protection. Wash with soap and water after handling.**

**Read precautionary information on product label (see Appendix IV) before proceeding.**

**It is a violation of US Federal Law to use this product in a manner inconsistent with its labeling.**

**Wearing rubber or latex gloves**, follow this procedure to replace each Anti-Foulant Device (two):

1. Remove the protective plug from the anti-foulant device cup;
2. Unscrew the cap with a  $\frac{5}{8}$ -inch socket wrench;
3. Remove the old Anti-Foulant Device. If the old device is difficult to remove:
  - Use needle-nose pliers and carefully break up material;
  - If necessary, remove the guard to provide easier access.

Place the new Anti-Foulant Device in the cup;

4. Rethread the cap onto the cup. Do not over tighten;
5. If the HydroCAT is to be stored, reinstall the protective plug. **Note that the plugs must be removed prior to deployment or pressurization.** If the plugs are left in place during deployment, the cell will not register conductivity. If left in place during pressurization, the cell may be destroyed.

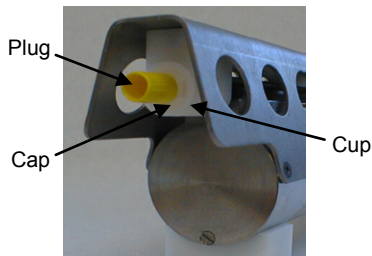
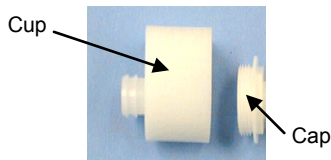

### **CAUTION:**

Anti-foulant device cups are attached to the guard and connected with tubing to the cell. **Removing the guard without disconnecting the cups from the guard will break the cell.** If the guard must be removed:

1. Remove the two screws connecting each anti-foulant device cup to the guard.
2. Remove the four Phillips-head screws connecting the guard to the housing and sensor end cap.
3. Gently lift the guard away.



## Sensor Calibration

### Notes:

- AA cells must be removed before returning the HydroCAT to Sea-Bird. Do not return used cells to Sea-Bird when shipping the HydroCAT for recalibration or repair.
- Please remove AF24173 Anti-Foulant Devices from the anti-foulant device cup before returning the HydroCAT to Sea-Bird. Store them for future use. See *Replacing Anti-Foulant Devices* for removal procedure.

Sea-Bird sensors are calibrated by subjecting them to known physical conditions and measuring the sensor responses. Coefficients are then computed, which may be used with appropriate algorithms to obtain engineering units. The sensors on the HydroCAT are supplied fully calibrated, with coefficients printed on their respective Calibration Certificates (see back of manual). These coefficients have been stored in the HydroCAT's EEPROM.

We recommend that HydroCATs be returned to Sea-Bird for calibration.

### Conductivity Sensor Calibration

The conductivity sensor incorporates a fixed precision resistor in parallel with the cell. When the cell is dry and in air, the sensor's electrical circuitry outputs a frequency representative of the fixed resistor. This frequency is recorded on the Calibration Certificate and should remain stable (within 1 Hz) over time.

The primary mechanism for calibration drift in conductivity sensors is the fouling of the cell by chemical or biological deposits. Fouling changes the cell geometry, resulting in a shift in slope. Accordingly, the most important determinant of long-term sensor accuracy is the cleanliness of the cell. We recommend that the conductivity sensor be calibrated before and after deployment, but particularly when the cell has been exposed to contamination by oil slicks or biological material.

### Temperature Sensor Calibration

The primary source of temperature sensor calibration drift is the aging of the thermistor element. Sensor drift will usually be a few thousandths of a degree during the first year, and less in subsequent intervals. Sensor drift is not substantially dependent upon the environmental conditions of use, and — unlike platinum or copper elements — the thermistor is insensitive to shock.

### Dissolved Oxygen Sensor (optional) Calibration

The primary mechanism for calibration drift in optical oxygen sensors is the fouling of the optical window by chemical or biological deposits. Accordingly, the most important determinant of long-term sensor accuracy is the cleanliness of the window. We recommend that oxygen sensors be calibrated before and after deployment, but particularly when the sensor has been exposed to contamination by oil slicks or biological material.

Another important mechanism for oxygen sensor drift is photobleaching of the sensor film. Keep the Hydro-DO sensor film out of direct sunlight if detached from the main body of the HydroCAT. Also, every sample that is taken illuminates the film with short wavelength light that eventually degrades the film. As a rule of thumb, re-calibration of the oxygen sensor on the HydroCAT is recommended when enough samples are taken to fill the HydroCAT's memory (300,000 to 500,000 samples).



Shown with conductivity cell guard and anti-foul fittings removed

## Pressure Sensor (optional) Calibration

The optional strain-gauge pressure sensor is a mechanical diaphragm type, with an initial static error band of 0.05%. Consequently, the sensor is capable of meeting the HydroCAT's 0.10% error specification with some allowance for aging and ambient-temperature induced drift.

Pressure sensors show most of their error as a linear offset from zero.

A technique is provided below for making small corrections to the pressure sensor calibration using the *offset* (**POffset=**) calibration coefficient term by comparing HydroCAT pressure output to readings from a barometer.

Allow the HydroCAT to equilibrate in a reasonably constant temperature environment for at least 5 hours before starting. Pressure sensors exhibit a transient change in their output in response to changes in their environmental temperature. Sea-Bird instruments are constructed to minimize this by thermally decoupling the sensor from the body of the instrument. However, there is still some residual effect; allowing the HydroCAT to equilibrate before starting will provide the most accurate calibration correction.

### Note:

The HydroCAT's pressure sensor is an absolute sensor, so its **raw** output includes the effect of atmospheric pressure (14.7 psi). As shown on the Calibration Sheet, Sea-Bird's calibration (and resulting calibration coefficients) is in terms of psia. However, when outputting pressure in **psi** or **decibars**, the HydroCAT outputs pressure relative to the ocean surface (i.e., at the surface the output pressure is 0 psi or 0 dbar). The HydroCAT uses the following equations to convert psia:

$$P(\text{psi}) = P(\text{psia}) - 14.7$$

$$P(\text{dbar}) = [P(\text{psia}) - 14.7] * 0.689476$$

1. Place the HydroCAT in the orientation it will have when deployed.
2. While connected in UCI:
  - A. Click **HydroCAT Settings**. Enable pressure output, and set pressure output units to decibars. Click **Upload**.
  - B. Click **Command Terminal**.
  - C. Set the pressure offset to 0.0 (**POffset=0**) and click **Submit**.
  - D. To take 20 samples and transmit data, type **TSN:20** and click **Submit**.
  - E. When HydroCAT finishes responding, highlight the data and copy it (Ctrl C); paste the data into a spreadsheet to calculate the average.
  - F. Close the Command Terminal.
3. Compare the HydroCAT output to the reading from a good barometer at the same elevation as the HydroCAT's pressure sensor port.  
Calculate *offset* = barometer reading – HydroCAT reading
4. In the Sensor menu, select HydroCAT / Advanced / Pressure Offset.  
Set the pressure offset using the calculated value (positive or negative), and click **OK**.

### Offset Correction Example

Absolute pressure measured by a barometer is 1010.50 mbar. Pressure displayed from HydroCAT is -2.5 dbar.

Convert barometer reading to dbar using the relationship: mbar \* 0.01 = dbar

Barometer reading = 1010.50 mbar \* 0.01 = 10.1050 dbar

The HydroCAT's internal calculations output gauge pressure, using an assumed value of 14.7 psi for atmospheric pressure. Convert HydroCAT reading from gauge to absolute by adding 14.7 psia to the HydroCAT's output:

-2.5 dbars + (14.7 psi \* 0.689476 dbar/psia) = -2.5 + 10.13 = 7.635 dbar

Offset = 10.1050 – 7.635 = + 2.47 dbar

Enter offset in HydroCAT.

For demanding applications, or where the sensor's air ambient pressure response has changed significantly, calibration using a dead-weight generator is recommended. The pressure sensor port uses a  $7/16$ -20 straight thread for mechanical connection to the pressure source. Use a fitting that has an O-ring tapered seal, such as Swagelok-200-1-4ST, which conforms to MS16142 boss.

# Section 6: Troubleshooting

This section reviews common problems in operating the HydroCAT, and provides the most common causes and solutions.

---

## Problem 1: Unable to Communicate with HydroCAT

**Cause/Solution 1:** The instrument communication settings may not have been entered correctly in UCI's Connect dialog. Verify the correct COM port has been selected, and that it is set to Try All Baud Rates.

**Cause/Solution 2:** The I/O cable connection may be loose. Check the cabling between the HydroCAT and computer for a loose connection.

**Cause/Solution 3:** There may be no battery pack in the HydroCAT. Open the connector end cap and verify that the battery pack is installed, and contains cells.

**Cause/Solution 4:** The I/O cable between the HydroCAT and computer may not be the correct one. The I/O cable supplied with the HydroCAT permits connection to standard 9-pin RS-232 interfaces.

---

## Problem 2: No Data Recorded

**Cause/Solution 1:** The memory may be full; once the memory is full, no further data will be recorded. Verify that the memory is not full using **GetSD** (`<SamplesFree>0</SamplesFree>` if memory is full). Sea-Bird recommends that you upload all previous data before beginning another deployment. Once the data is uploaded, click **Deploy HydroCAT** and select Clear HydroCAT data in Step 3 to reset the memory. After the memory is reset, **GetSD** will show `<Samples>0</Samples>`.

---

## Problem 3: Unreasonable T, C, P, or D.O. Data

The symptom of this problem is a data file that contains unreasonable values (for example, values that are outside the expected range of the data).

**Cause/Solution 1:** A data file with unreasonable (i.e., out of the expected range) values for temperature, conductivity, pressure, or dissolved oxygen may be caused by incorrect calibration coefficients in the HydroCAT. In the Command Terminal, send **GetCC** to verify the calibration coefficients in the HydroCAT match the instrument Calibration Certificates. Note that calibration coefficients do not affect the raw data stored in HydroCAT memory.

- If you have not yet overwritten the memory with new data, you can correct the coefficients and then upload the data again.

**Cause/Solution 2:** Minimal changes in **conductivity** are an indication that the pump flow is not correct. Poor flushing can have several causes:

- Air in the plumbing may be preventing the pump from priming. This can result from:
  - Air in the system. We recommend running the pump for 5 minutes upon initial deployment to remove any air; see *Optimizing Data Quality* in *Section 4: Deploying and Operating HydroCAT*.
  - Incorrect orientation for a shallow deployment in a location with breaking waves; see *Optimizing Data Quality* in *Section 4: Deploying and Operating HydroCAT*.
- The pump may be clogged by sediment. Using a wash bottle, flush the plumbing to attempt to dislodge the sediment. If the sediment is impacted and you cannot flush it, return the HydroCAT to Sea-Bird for servicing. To minimize ingestion of sediment for future deployments, see *Optimizing Data Quality* in *Section 4: Deploying and Operating HydroCAT*.
- The pump may not be turning on before each sample, if the Minimum Conductivity Frequency is set too high. See *Pump Operation* in *Section 2: Description of HydroCAT*.

---

## Problem 4: Salinity Spikes

Salinity is a function of conductivity, temperature, and pressure, and must be calculated from C, T, and P measurements made on the same parcel of water. Salinity is calculated and output by the HydroCAT if it is enabled in the HydroCAT Settings dialog.

[*Background information:* Salinity spikes in **profiling** (i.e., moving, fast sampling) instruments typically result from misalignment of the temperature and conductivity measurements in conditions with sharp gradients. This misalignment is often caused by differences in response times for the temperature and conductivity sensors, and can be corrected for in post-processing if the T and C response times are known.]

In **moored**, pumped instruments such as the HydroCAT, the pump flushes the conductivity cell at a faster rate than the environment changes, so the T and C measurements stay closely synchronized with the environment (i.e., even slow or varying response times are not significant factors in the salinity calculation). More typical causes of salinity spikes in a HydroCAT include:

**Cause/Solution 1:** Severe external bio-fouling can restrict flow through the conductivity cell to such an extent that the conductivity measurement is significantly delayed from the temperature measurement.

**Cause/Solution 2:** For a HydroCAT moored at shallow depth, differential solar heating can cause the actual temperature inside the conductivity cell to differ from the temperature measured by the thermistor. Salinity spikes associated mainly with daytime measurements during sunny conditions may be caused by this phenomenon.

**Cause/Solution 3:** For a HydroCAT moored at shallow depth, air bubbles from breaking waves or spontaneous formation in supersaturated conditions can cause the conductivity cell to read low of correct.

# Glossary

**Battery pack** – 12 AA lithium cells in a battery holder that connects 4 cells in series and each series string in parallel. Battery pack uses:

- Saft LS 14500, AA, 3.6 V and 2.6 Amp-hours each ([www.saftbatteries.com](http://www.saftbatteries.com)) (**recommended**),
- Tadiran TL-4903, AA, 3.6 V and 2.4 Amp-hours each ([www.tadiran.com](http://www.tadiran.com)), or
- Electrochem 3B0064/BCX85, AA, 3.9 V and 2.0 Amp-hours each ([www.electrochemsolutions.com](http://www.electrochemsolutions.com))

**Deployment Endurance Calculator** – Sea-Bird's Windows software used to calculate deployment length for moored instruments, based on user-input deployment scheme, instrument power requirements, and battery capacity.

**Fouling** – Biological growth in the conductivity cell and in the optional oxygen sensor plenum during deployment.

**HydroCAT** – High-accuracy conductivity, temperature, optional pressure, and optional Dissolved Oxygen Recorder. The HydroCAT is available with RS-232 interface or RS-232 interface and SDI-12 interface. **This manual is for a HydroCAT with or without Pressure, with both RS-232 and SDI-12 interfaces, without Dissolved Oxygen.**

**PCB** – Printed Circuit Board.

**Scan** – One data sample containing temperature, conductivity, optional pressure, oxygen, and date and time, as well as optional derived variables (salinity, sound velocity, specific conductivity).

**CAUTION:**

**Do not use Parker O-Lube, which is petroleum based; use only Super O-Lube.**

**Super O-Lube** – Silicone lubricant used to lubricate O-rings and O-ring mating surfaces. Super O-Lube can be ordered from Sea-Bird, but should also be available locally from distributors. Super O-Lube is manufactured by Parker Hannifin ([www.parker.com/ead/cm2.asp?cmid=3956](http://www.parker.com/ead/cm2.asp?cmid=3956)).

**TCXO** – Temperature Compensated Crystal Oscillator.

**Triton X-100** – Reagent grade non-ionic surfactant (detergent), used for cleaning the conductivity cell. Triton can be ordered from Sea-Bird, but should also be available locally from chemical supply or laboratory products companies. Triton is manufactured by Avantor Performance Materials ([www.avantormaterials.com/commerce/product.aspx?id=2147509608](http://www.avantormaterials.com/commerce/product.aspx?id=2147509608)).

**UCI** – Universal Coastal Interface; software designed for communications, setup, data viewing, and data upload from HydroCAT.

# Appendix I: Functional Description

## Sensors

The HydroCAT embodies the same sensor elements (3-electrode, 2-terminal, borosilicate glass cell, and pressure-protected thermistor) previously employed in Sea-Bird Electronics' modular SBE 3 and SBE 4 sensors and in the SeaCAT and SeaCAT*plus* family.

**Note:**

Pressure ranges are expressed in meters of deployment depth capability.

The HydroCAT's optional strain-gauge pressure sensor is available in 20, 100, and 350 meter pressure ranges. Compensation of the temperature influence on pressure offset and scale is performed by the HydroCAT's CPU.

The optional Optical Dissolved Oxygen sensor is a Hydro-DO Dissolved Oxygen sensor, with the same performance specifications.

---

## Sensor Interface

Temperature is acquired by applying an AC excitation to a hermetically sealed VISHAY reference resistor and an ultra-stable aged thermistor with a drift rate of less than 0.002°C per year. A 24-bit A/D converter digitizes the outputs of the reference resistor and thermistor (and optional pressure sensor).

AC excitation and ratiometric comparison using a common processing channel avoids errors caused by parasitic thermocouples, offset voltages, leakage currents, and reference errors.

Conductivity is acquired using an ultra-precision Wien Bridge oscillator to generate a frequency output in response to changes in conductivity.

---

## Real-Time Clock

To minimize power and improve clock accuracy, a temperature-compensated crystal oscillator (TCXO) is used as the real-time-clock frequency source. The TCXO is accurate to  $\pm 1$  minute per year (0 °C to 40 °C).

# Appendix II: Electronics Disassembly/Reassembly

**CAUTION:**

See *Section 5: Routine Maintenance and Calibration* for handling instructions for the plastic housing.

**Disassembly:**

1. Remove the connector end cap and battery pack following instructions in *Section 3: Preparing HydroCAT for Deployment*.

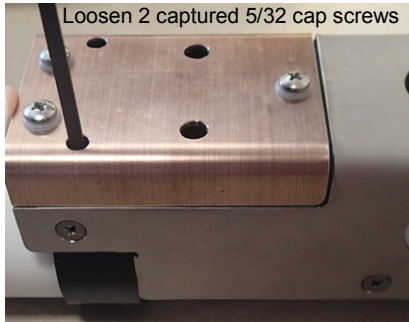

2. Loosen the two captured 5/32" cap screws holding the copper anti-foulant assembly to the housing clamp, using the 5/32-inch Allen wrench included with the shipment. Carefully remove the copper anti-foulant assembly.

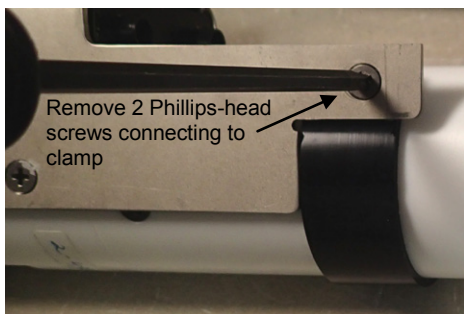

3. Remove the two Phillips-head screws holding the cell guard to the clamp.



4. Remove the six Phillips-head screws holding the cell guard to the housing and end cap.

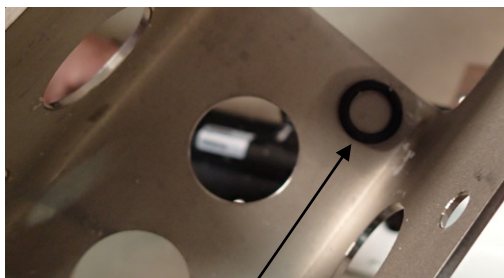

Remove O-ring and put aside for later

5. **Carefully** pull off the cell guard. Note that an O-ring may be stuck on the inside of the cell guard; put this aside for re-installation on the exhaust when done.

- 6. Remove the three Phillips-head screws that were covered by the cell guard.

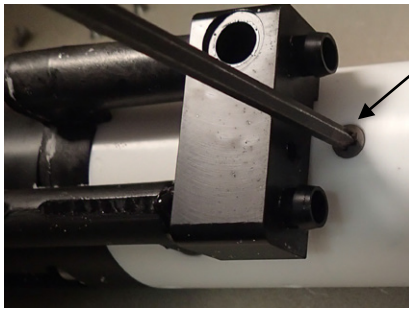

Remove 3 Phillips-head screws going through housing

- 7. Put one of the removed cap screws from the **connector** end cap in the machined detail. **Carefully** twist the housing; the housing will release from the end cap.



Machined detail – place cap screw here



Hold carefully as shown, and twist housing



- 8. The electronics are on a sandwich of rectangular PCBs. These PCBs are assembled to a bulkhead. To remove the PCB assembly:
  - A. Use a small Phillips-head screwdriver (#1) to remove the Phillips-head threaded rod (198 mm [7.8 inch]).
  - B. Holding the edges of the PCB assembly, carefully pull it out from the edge connector.

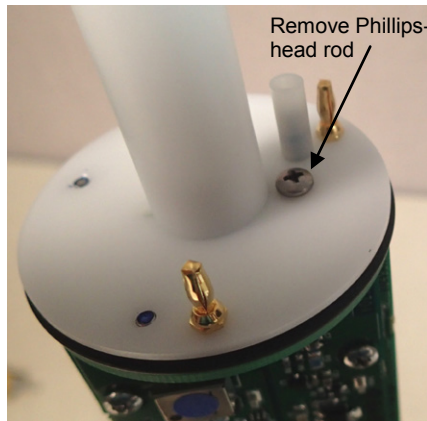

Remove Phillips-head rod

Hold edges of PCB assembly and carefully pull







### Reassembly:

1. Replace the PCB assembly as shown at left. Place LocTite<sup>®</sup> 222 to the bottom two threads on the Phillips-head rod; insert and tighten gently. A gentle resistance can be felt as the PCB assembly mates to the edge connector. If the rod will not tighten, the PCBs have not fully mated or are mated in reverse.

#### Note:

Before delivery, a desiccant package is inserted in the housing and the electronics chamber is filled with dry Argon gas to help prevent condensation. To ensure proper functioning:

1. Install a new desiccant bag each time you open the electronics chamber. If a new bag is not available, see *Application Note 71: Desiccant Use and Regeneration (drying)*.
2. If possible, dry gas backfill each time you open the housing. If you cannot, wait at least 24 hours before redeploying, to allow the desiccant to remove any moisture.

Note that opening the battery compartment does not affect desiccation of the electronics.

#### CAUTION:

**Do not use Parker O-Lube, which is petroleum based; use only Super O-Lube.**

2. Replace the housing on the end cap:
  - A. Remove any water from the O-rings and mating surfaces with a lint-free cloth or tissue. Inspect the O-rings and mating surfaces for dirt, nicks, and cuts. Clean as necessary. Apply a light coat of O-ring lubricant (Parker Super O Lube) to the O-rings and mating surfaces.
  - B. Carefully fit the housing onto the end cap until the O-rings are fully seated.
  - C. Reinstall the three Phillips-head screws to secure the housing.

O-ring on exhaust

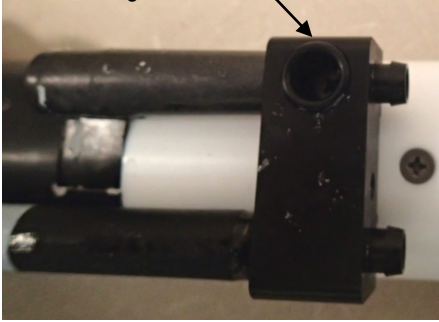

3. **Place the O-ring from Step 5 of the disassembly procedure on the exhaust.** Reinstall the cell guard on the housing and end cap, using the six Phillips-head screws.
4. Reinstall the two Phillips-head screws to connect the clamp to the cell guard.

Push copper anti-foulant assembly while tightening captured cap screws

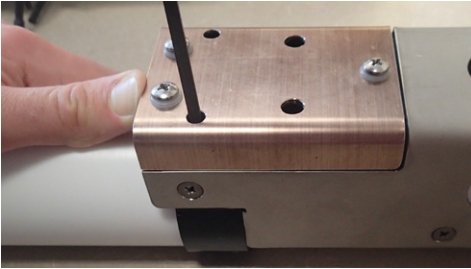

5. Replace the copper anti-foulant assembly on the housing. Secure the copper guard assembly to the housing with the two captured cap screws; alternate tightening the screws to secure, maintaining even gaps on the sides.
6. Reinstall the battery pack and end cap following instructions in *Section 3: Preparing HydroCAT for Deployment.*

# Appendix III: RS-232 Command Summary and Details

## Note:

For communications via a terminal program:  
Terminal program baud rate must be the same as the HydroCAT baud rate. Baud is factory-set to 19200, but can be changed by the user (**BaudRate=**). Other communication parameters – 8 data bits, 1 stop bit, and no parity – cannot be changed.

This section describes all commands that can be sent to the HydroCAT via RS-232 (through a terminal program). It is meant for reference for advanced users; most setup commands can be more easily sent through the UCI software.

The Appendix is in two parts:

- Command Summary provides a quick reference list of commands, with brief explanations.
- Detailed Command Descriptions provides more information about the commands (notes, examples, sample outputs, etc.).

Entries made with the commands are permanently stored in the HydroCAT and remain in effect until you change them. When entering commands:

- Input commands to the HydroCAT in upper or lower case letters and register commands by pressing the Enter key. Note that commands are shown with a mix of upper and lower case for ease in reading (for example, **MinCondFreq=**), but do not need to be entered that way.
- The HydroCAT sends an error message if an invalid command is entered.
- Commands to enable a parameter (such as enabling output of salinity) can be entered with the *argument* as Y or 1 for yes, and N or 0 for no (for example, **OutputSal=y** and **OutputSal=1** are equivalent; both enable salinity output).
- If a new command is not received within 2 minutes after the completion of a command, the HydroCAT returns to the quiescent (sleep) state.
- If in quiescent (sleep) state, re-establish communications by pressing the Enter key.
- If the HydroCAT is transmitting data and you want to stop it, press the Esc key or type ^C. Then press the Enter key.
- The HydroCAT responds only to **GetCD**, **GetSD**, **GetCC**, **GetEC**, **GetHD**, **DS**, **DC**, **TS**, **TSR**, **TPS**, **SL**, **QS**, and **Stop** while sampling autonomously (**StartNow** has been sent). If you wake the HydroCAT while it is pumping or sampling (for example, to send **DS** to check on progress):
  - (if **OutputExecutedTag=Y**) The HydroCAT responds with one or more `<Executing>` tags until the sample is complete, and then responds to the command.
  - (if **OutputExecutedTag=N**) The HydroCAT responds to the command after the sample is complete.
- The HydroCAT responds only to **GetCD**, **GetSD**, **GetCC**, **GetEC**, **GetHD**, **DS**, **DC**, **TS**, **TSR**, **TPS**, **SL**, **QS**, and **Stop** while waiting to start autonomous sampling (**StartLater** has been sent). To send any other commands, send **Stop**, send the desired commands to modify the setup, and then send **StartLater** again.

## Command Summary

**Note:**  
See *Detailed Command Descriptions* below for detailed information and examples.

CATEGORY	COMMAND	DESCRIPTION
Status	<b>GetCD</b>	Display configuration data.
	<b>GetSD</b>	Display status data.
	<b>GetCC</b>	Display calibration coefficients.
	<b>GetEC</b>	Display event counter data.
	<b>ResetEC</b>	Reset event counter.
	<b>GetHD</b>	Display hardware data.
	<b>Help</b>	Display list of currently available commands.
	<b>DS</b>	Display status and configuration data.
General Setup	<b>DC</b>	Display calibration coefficients.
	<b>DateTime=mmddyyhhmmss</b>	Set real-time clock month, day, year, hour, minute, second.
	<b>BaudRate=x</b>	x= baud rate for <b>RS-232</b> communications (4800, 9600, 19200, 38400, 57600, or 115200). Default 19200. <i>Note: 1200 baud is used for SDI-12 communication, and is independent of baud set for RS-232 communication.</i>
	<b>ReferencePressure=x</b>	x= reference pressure (gauge) in decibars used for conductivity (and specific conductivity, salinity, and sound velocity) computation, <i>Adaptive Pump Control</i> algorithm, and oxygen calculation when HydroCAT does not have pressure sensor).
	<b>*Default</b>	Reset most user-input settings to factory defaults.
RS-232 Setup	<b>QS</b>	Enter quiescent (sleep) state. Main power turned off, but data logging and memory retention unaffected.
	<b>OutputExecutedTag=x</b>	x=Y: Display XML Executing and Executed tags for <b>RS-232</b> communications. x=N: Do not.
SDI-12 Setup	<b>TxRealTime=x</b>	x=Y: Output real-time data for <b>RS-232</b> communications while sampling autonomously. x=N: Do not.
	<b>SetAddress=x</b>	x= address (0-9, a-z, A-Z) for <b>SDI-12</b> communications.
Pump Setup	<b>SetSDI12Flag=x</b>	x= out-of-range value (-9999999 to +9999999; must include + or - sign) for <b>SDI-12</b> communications ( <b>OutputFormat=3</b> ). <b>Default +9999999</b> . If HydroCAT calculates out of range data for a particular parameter, this value is inserted in data stream for that parameter.
	<b>MinCondFreq=x</b>	x= minimum conductivity frequency (Hz) to enable pump turn-on.
	<b>AdaptivePumpControl=x</b>	x=Y: If oxygen sensor installed, run pump before each sample using <i>Adaptive Pump Control</i> ; run pump for [OxNTau * OxTau20 * ft * fp]. <b>Default</b> . x=N: If oxygen sensor installed, do not use <i>Adaptive Pump Control</i> ; run pump before each sample for [OxNTau * OxTau20].
	<b>OxNTau=x</b>	x= pump time multiplier (0 – 100.0). <b>Default 7.0</b> .
	<b>PumpOn</b>	Turn pump on for testing or to remove sediment.
Memory Setup	<b>PumpOff</b>	Turn pump off, if turned on with <b>PumpOn</b> .
	<b>InitLogging</b>	Initialize logging to make entire memory available for recording.
	<b>SampleNumber=x</b>	x= sample number for last sample in memory. <b>SampleNumber=0</b> equivalent to <b>InitLogging</b> .

**Note:**  
 Commands that enable/disable parameter outputs (temperature, conductivity, pressure, salinity, sound velocity, specific conductivity, sample number) only apply if **OutputFormat=1, 2, or 3**. Raw output (**OutputFormat=0**) is not affected by enabling / disabling parameter outputs.

CATEGORY	COMMAND	DESCRIPTION
Output Format Setup	<b>OutputFormat=x</b>	x=0: Output raw decimal data. x=1: Output converted decimal data x=2: Output converted decimal data in XML format. x=3: Output converted decimal data in SDI-12 format.
	<b>OutputTemp=x</b>	x=Y: Output temperature. x=N: Do not.
	<b>SetTempUnits=x</b>	x=0: Temperature °C, ITS-90. x=1: Temperature °F, ITS-90.
	<b>OutputCond=x</b>	x=Y: Output conductivity. x=N: Do not.
	<b>SetCondUnits=x</b>	x=0: Conductivity and specific conductivity S/m. x=1: Conductivity and specific conductivity mS/cm. x=2: Conductivity and specific conductivity µS/cm.
	<b>OutputPress=x</b>	x=Y: Output pressure (if pressure sensor installed). x=N: Do not.
	<b>SetPressUnits=x</b>	x=0: Pressure decibars. x=1: Pressure psi (gauge).
	<b>OutputOx=x</b>	x=Y: Output oxygen (if oxygen sensor installed). x=N: Do not.
	<b>SetOxUnits=x</b>	x=0: Oxygen ml/L. x=1: Oxygen mg/L.
	<b>OutputSal=x</b>	x=Y: Calculate and output salinity (psu). x=N: Do not.
	<b>OutputSV=x</b>	x=Y: Calculate and output sound velocity (m/sec). x=N: Do not.
	<b>OutputSC=x</b>	x=Y: Calculate and output specific conductivity. x=N: Do not.
	<b>UseSCDefault=x</b>	<i>Only applicable if OutputSC=y.</i> x=0: Do not use default; use SetSCA=. x=1: Use default value (0.020) for thermal coefficient of conductivity for natural salt ion solutions (specific conductivity calculation).
	<b>SetSCA=x</b>	<i>Only applicable if OutputSC=y and UseSCDefault=0.</i> x= thermal coefficient of conductivity for natural salt ion solutions (specific conductivity calculation).
<b>TxSampleNum=x</b>	x=Y: Output sample number with each <i>polled</i> sample. x=N: Do not.	
Autonomous Sampling (Logging)	<b>SampleInterval=x</b>	x= interval (sec) between samples (6 - 21600).
	<b>StartNow</b>	Start logging now.
	<b>StartDateTime=mmddyyhhmmss</b>	Delayed logging start: month, day, year, hour, minute, second.
	<b>StartLater</b>	Start logging at delayed logging start time.
	<b>Stop</b>	Stop logging or waiting to start. Press Enter key before entering <b>Stop</b> . Must stop before uploading data.

**Note:**  
 Do not set **SampleInterval=** to less than (pumping time + sampling time + 5 sec).

CATEGORY	COMMAND	DESCRIPTION
<b>Polled Sampling</b>	<b>TS</b>	<b>Do not pump.</b> Take sample, store in buffer, output.
	<b>TSR</b>	<b>Do not pump.</b> Take sample, store in buffer, output in raw decimal format.
	<b>TPS</b>	Run pump, take sample, store in buffer, output.
	<b>TPSS</b>	Run pump, take sample, store in buffer and in FLASH memory, output.
	<b>TSN:x</b>	<b>Do not pump.</b> Take x samples and output data.
	<b>TPSN:x</b>	Run pump continuously while taking x samples and outputting.
	<b>T63</b>	<b>Do not pump.</b> Take sample from Hydro-DO, output oxygen data in format set by <b>SetFormat=</b> in <i>Hydro-DO</i> .
	<b>SL</b>	Output last sample stored in buffer.
<b>Data Upload</b> (send <b>Stop</b> before sending upload command)	<b>GetSamples:b,e</b>	Upload scan <b>b</b> to <b>e</b> , format defined by <b>OutputFormat=</b> . Maximum of 5000 samples can be uploaded at one time.
<b>Coefficients</b> (F=floating point number; S=string with no spaces)  Dates shown are when calibrations were performed. Calibration coefficients are initially factory-set and should agree with Calibration Certificates shipped with HydroCATs. View all coefficients with <b>GetCC</b> or <b>DC</b> .	<b>TCalDate=S</b>	S=Temperature calibration date.
	<b>TA0=F</b>	F=Temperature A0.
	<b>TA1=F</b>	F=Temperature A1.
	<b>TA2=F</b>	F=Temperature A2.
	<b>TA3=F</b>	F=Temperature A3.
	<b>CCalDate=S</b>	S=Conductivity calibration date.
	<b>CG=F</b>	F=Conductivity G.
	<b>CH=F</b>	F=Conductivity H.
	<b>CI=F</b>	F=Conductivity I.
	<b>CJ=F</b>	F=Conductivity J.
	<b>WBOTC=F</b>	F=Conductivity wbotc.
	<b>CTCor=F</b>	F=Conductivity ctcor.
	<b>CPCor=F</b>	F=Conductivity cpcor.
	<b>PCalDate=S</b>	S=Pressure calibration date.
	<b>PA0=F</b>	F=Pressure A0.
	<b>PA1=F</b>	F=Pressure A1.
	<b>PA2=F</b>	F=Pressure A2.
	<b>PTCA0=F</b>	F=Pressure ptca0
	<b>PTCA1=F</b>	F=Pressure ptca1.
	<b>PTCA2=F</b>	F=Pressure ptca2.
	<b>PTCB0=F</b>	F=Pressure ptcb0.
	<b>PTCB1=F</b>	F=Pressure ptcb1.
	<b>PTCB2=F</b>	F=Pressure ptcb2.
	<b>PTempA0=F</b>	F=Pressure temperature a0.
	<b>PTempA1=F</b>	F=Pressure temperature a1.
	<b>PTempA2=F</b>	F=Pressure temperature a2.
	<b>POffset=F</b>	F=Pressure offset (decibars).
	<b>OxCalDate=S</b>	S= Oxygen calibration date.
	<b>OxTau20=F</b>	F= Oxygen Tau20 (sensor response time).
	<b>OxA0=F</b>	F= Oxygen A0 coefficient.
	<b>OxA1=F</b>	F= Oxygen A1 coefficient.
	<b>OxA2=F</b>	F= Oxygen A2 coefficient.
	<b>OxB0=F</b>	F= Oxygen B0 coefficient.
	<b>OxB1=F</b>	F= Oxygen B1 coefficient.
<b>OxC0=F</b>	F= Oxygen C0 coefficient.	
<b>OxC1=F</b>	F= Oxygen C1 coefficient.	
<b>OxC2=F</b>	F= Oxygen C2 coefficient.	
<b>OxTA0=F</b>	F= Oxygen TA0 coefficient.	
<b>OxTA1=F</b>	F= Oxygen TA1 coefficient.	
<b>OxTA2=F</b>	F= Oxygen TA2 coefficient.	
<b>OxTA3=F</b>	F= Oxygen TA3 coefficient.	
<b>OxE=F</b>	F= Oxygen E coefficient.	

## Detailed Command Descriptions

### Notes:

- **GetCD** output does not include calibration coefficients. To display calibration coefficients, use the **GetCC** command.
- Lines describing what parameters to output (temperature, conductivity, pressure, oxygen, salinity, sound velocity, specific conductivity, sample number) only appear if **OutputFormat=1, 2, or 3**. Raw output (**OutputFormat=0**) is not affected by enabling / disabling parameter outputs.

### Status Commands

#### GetCD

Get and display configuration data, which includes parameters related to HydroCAT setup. Most of these parameters can be user-input/modified. List below includes, where applicable, command used to modify parameter:

- Device type, Serial number
- Optional pressure sensor installed?
- Reference pressure (dbar) to use in calculations if no pressure sensor installed (only sent if pressure not installed) [**ReferencePressure=**]
- Output data format [**OutputFormat=**]
- Frame sync [factory-set]
- Units for:
  - temperature [**SetTempUnits=**], conductivity and specific conductivity [**SetCondUnits=**], pressure [**SetPressUnits=**], oxygen [**SetOxUnits=**]
- Output with each sample:
  - temperature [**OutputTemp=**]?
  - conductivity [**OutputCond=**]?
  - pressure [**OutputPress=**]?
  - oxygen [**OutputOx=**]?
  - salinity [**OutputSal=**]?
  - sound velocity [**OutputSV=**]?
  - specific conductivity [**OutputSC=**]?
- Specific conductivity temperature coefficient [**UseSCDefault=** and **SetSCA=**]
- Output sample number with real-time autonomous data and polled data from memory [**TxSampleNum=**]?
- Interval between samples for autonomous sampling [**SampleInterval=**]
- Transmit autonomous data real-time [**TxRealTime=**]?
- Minimum conductivity frequency for pump turn-on [**MinCondFreq=**]
- Adaptive pump control enabled [**AdaptivePumpControl=**]? (only sent if oxygen installed)
- Pump time multiplier [**OxNTau=**]. (only sent if oxygen installed)
- Pump-on time for each measurement [**OxNTau \* OxTau20**] if Adaptive Pump Control disabled (only sent if oxygen installed Adaptive Pump Control disabled).
- SDI-12 address [**SetAddress=**]
- Out of range value for **OutputFormat=3** and SDI-12 communications [**SetSDI12Flag=**]

---

**Status Commands** *(continued)*

---

*Example:* HydroCAT with pressure and oxygen sensors (user input in bold, command used to modify parameter in parentheses).

**GETCD**

```

<ConfigurationData DeviceType = 'HydroCAT-SDI12' SerialNumber = '03732345'>
  <PressureInstalled>yes</PressureInstalled>           (inclusion of optional pressure sensor set at factory)
  <SampleDataFormat>converted engineering</SampleDataFormat>           [OutputFormat=]
  <FrameSync>HCAT</FrameSync>                               [factory-set]
  <TemperatureUnits>Celsius</TemperatureUnits>           [SetTempUnits=]
  <ConductivityUnits>µS/m</ConductivityUnits>           [SetCondUnits=]
  <PressureUnits>PSI</PressureUnits>           [SetPressUnits=]
  <OutputTemperature>yes</OutputTemperature>           [OutputTemp=]
  <OutputConductivity>yes</OutputConductivity>           [OutputCond=]
  <OutputPressure>yes</OutputPressure>           [OutputPress=]
  <OutputSalinity>yes</OutputSalinity>           [OutputSal=]
  <OutputSV>yes</OutputSV>           [OutputSV=]
  <OutputSC>yes</OutputSC>           [OutputSC=]
  <SCCoeff>0.0200</SCCoeff>           [UseSCDefault= and SetSCA=]
  <TxSampleNumber>yes</TxSampleNumber>           [TxSampleNum=]
  <SampleInterval>300</SampleInterval>           [SampleInterval=]
  <TxRealTime>yes</SampleInterval>           [TxRealTime=]
  <MinCondFreq>3224.1</MinCondFreq>           [MinCondFreq=]
  <AdaptivePumpControl>yes</AdaptivePumpControl>           [AdaptivePumpControl=]
  <nTau>7.0</nTau>           [OxNTau=]
  <SDI12Address>0</SDI12Address>           [SetAddress=]
  <SDI12Flag>+9999999</SDI12Flag>           [SetSDI12Flag=]
</ConfigurationData>

```



**Status Commands** (*continued*)**GetSD**

Get and display status data, which contains data that changes while deployed.

List below includes, where applicable, command used to modify parameter:

- Device type, Serial number
- Date and time [**DateTime=**] in ISO8601-2000 extended format (yyyy – mm-ddThh:mm:ss)
- Number of recorded events in event counter [reset with **ResetEC**]
- Voltages – main battery pack voltage and back-up lithium cell voltage
- Memory – [reset with **InitLogging**]
  - Number of bytes in memory
  - Number of samples in memory
  - Number of additional samples that can be placed in memory
  - Length (number of bytes) of each sample
- Logging status –
  - yes or no (to indicate whether it is currently logging data);
  - if applicable, reason that logging has stopped

*Example:* (user input in bold, command used to modify parameter in parentheses)

**getsd**

```

<StatusData DeviceType = 'HydroCAT-SDI12' SerialNumber = '03732345'>
  <DateTime>2015-10-31T00:48:32</DateTime>                                [DateTime=]
  <EventSummary numEvents = '0' />                                       [can clear with ResetEC=]
  <Power>
    <vMain> 13.32</vMain>
    <vLith> 3.19</vLith>
  </Power>
  <MemorySummary>
    <Bytes>0</Bytes>
    <Samples>0</Samples>                                                 [can clear with InitLogging]
    <SamplesFree>559240</SamplesFree>                                     [can clear with InitLogging]
    <SampleLength>15</SampleLength>
  </MemorySummary>
  <AutonomousSampling>no, stop command</AutonomousSampling>          [StartNow or StartLater, Stop]
</StatusData>

```

**Note:**

Dates shown are when calibrations were performed.

**Status Commands** (*continued*)**GetCC**

Get and display calibration coefficients, which are initially factory-set and should agree with Calibration Certificates shipped with HydroCAT. Optional oxygen sensor calibration coefficients in response are programmed into integrated Hydro-DO.

Example: HydroCAT with a pressure sensor (user input in bold, command used to modify parameter in parentheses)

**getcc**

```

<CalibrationCoefficients DeviceType = 'HydroCAT-SDI12' SerialNumber = '03732345'>
  <Calibration format = 'TEMP1' id = 'Temperature'>
    <SerialNum>03732345</SerialNum>
    <CalDate>04-Oct-15</CalDate> [TCalDate=]
    <A0>6.947802e-05</A0> [TA0=]
    <A1>2.615233e-04</A1> [TA1=]
    <A2>-1.265233e-06</A2> [TA2=]
    <A3>1.310479e-07</A3> [TA3=]
  </Calibration>
  <Calibration format = 'WBCOND0' id = 'Conductivity'>
    <SerialNum>03732345</SerialNum>
    <CalDate>04-Oct-15</CalDate> [CCalDate=]
    <G>-1.009121e+00</G> [CG=]
    <H>1.410162e-01</H> [CH=]
    <I>-2.093167e-04</I> [CI=]
    <J>3.637053e-05</J> [CJ=]
    <PCOR>-9.570000e-08</PCOR> [CTCor=]
    <TCOR>3.250000e-06</TCOR> [CPCor=]
    <WBOTC>1.954800e-05</WBOTC> [CWBOTC=]
  </Calibration>
  <Calibration format = 'STRAIN0' id = 'Pressure'>
    <SerialNum>2478619</SerialNum>
    <CalDate>28-Oct-15</CalDate> [PCalDate=]
    <PA0>1.729067e+00</PA0> [PA0=]
    <PA1>1.415754e-01</PA1> [PA1=]
    <PA2>1.246912e-08</PA2> [PA2=]
    <PTCA0>2.243971e+00</PTCA0> [PTCA0=]
    <PTCA1>1.055267e+00</PTCA1> [PTCA1=]
    <PTCA2>-2.276308e-02</PTCA2> [PTCA2=]
    <PTCB0>1.003849e+02</PTCB0> [PTCB0=]
    <PTCB1>1.014510e-02</PTCB1> [PTCB1=]
    <PTCB2>-2.057110e-04</PTCB2> [PTCB2=]
    <PTEMPA0>5.669780e+01</PTEMPA0> [PTempA0=]
    <PTEMPA1>-5.474043e-02</PTEMPA1> [PTempA1=]
    <PTEMPA2>1.267908e-05</PTEMPA2> [PTempA2=]
    <POFFSET>0.000000e+00</POFFSET> [POffset= (decibars)]
    <PRANGE>0.000000e+00</PRANGE> [PRange= (psi)]
  </Calibration>
  <Calibration format = 'OXYGEN1' id = 'Oxygen'>
    <SerialNum>12</SerialNum>
    <CalDate>28-Jul-15</CalDate> [OxCalDate=]
    <TAU20>4.000000e+00</TAU20> [OxTau20=]
    <NTAU>7.000000e+00</NTAU> [OxNTau=]
    <OXA0>1.051300e+00</OXA0> [OxA0=]
    <OXA1>-1.500000e-03</OXA1> [OxA1=]
    <OXA2>4.161926e-01</OXA2> [OxA2=]
    <OXB0>-2.325492e-01</OXB0> [OxB0=]
    <OXB1>1.692931e+00</OXB1> [OxB1=]
    <OXC0>8.966704e-02</OXC0> [OxC0=]
    <OXC1>3.617471e-03</OXC1> [OxC1=]
    <OXC2>5.112384e-05</OXC2> [OxC2=]
    <OXTA0>6.517293e-04</OXTA0> [OxTA0=]
    <OXTA1>2.533749e-04</OXTA1> [OxTA1=]
    <OXTA2>3.140482e-07</OXTA2> [OxTA2=]
    <OXTA3>1.064506e-07</OXTA3> [OxTA3=]
    <OXE>1.100000e-02</OXE> [OxE=]
  </Calibration>
</CalibrationCoefficients>

```

**Status Commands** (*continued*)**GetEC**

Get and display event counter data, which can help to identify root cause of a malfunction. Event counter records number of occurrences of common timeouts, power-on resets, etc. Can be cleared with **ResetEC**. Possible events that may be logged include:

- WDT reset – unexpected reset
- PON reset - power cycled on (each time power is applied)
- ErrorADC12TimeOut – response delayed from A/D converter that measures main power and back-up lithium cell power
- ErrorUART0TimeOut – timeout for transmitter to finish transmitting previous character via RS-232
- ErrorAD7714TimeOut – response delayed from temperature and pressure A/D converter
- ErrorInvWakeUpFlag – unexpected wakeup
- ErrorFLASHTimeOut – problem with writing data to FLASH memory
- Alarm long - time to take next sample is too far in future
- Alarm short - woke up HydroCAT to send a command while logging, and missed taking a sample
- LoggingRestartNoAlarm – no sample taken for 8 hours while logging, restart logging
- LoggingRestartPON – power cycled while logging, logging restarted
- ErrorSBE63Timeout – Hydro-DO not responding within 1.5 sec of when power applied by HydroCAT

*Example:* (user input in bold, command used to modify parameter in parentheses)

**getec**

```
<EventCounters DeviceType = 'HydroCAT-SDI-12' SerialNumber = '03732345'>
  <EventSummary numEvents = '1' /> [can clear with ResetEC]
  <Event type = 'PON reset' count = '1' /> [can clear with ResetEC]
</EventCounters>
```

**ResetEC**

Delete all events in event counter (number of events displays in **GetSD** response, and event details display in **GetEC** response).

**Status Commands** (*continued*)**GetHD**

Get and display hardware data, which is fixed data describing HydroCAT:

- Device type, Serial number
- Manufacturer
- Firmware version
- Firmware date
- PCB serial numbers and assembly numbers
- Manufacture date
- Sensor types and serial numbers

*Example:* (user input in bold, command used to modify parameter in parentheses)

**gethd**

```
<HardwareData DeviceType = 'HydroCAT-SDI12' SerialNumber = '03732345'>
  <Manufacturer>Sea-Bird Electronics, Inc.</Manufacturer>
  <FirmwareVersion>2.13.0</FirmwareVersion>
  <FirmwareDate>Apr 29 2015 16:32:14</FirmwareDate>
  <CommandSetVersion>1.4</CommandSetVersion>
  <PCBAssembly SerialNum='60668' AssemblyNum='41783H' />
  <PCBAssembly SerialNum='56641' AssemblyNum='41785B' />
  <PCBAssembly SerialNum='60436' AssemblyNum='41661B' />
  <MfgDate>30 Aug 2015</MfgDate>
  <FirmwareLoader> SBE 37-232-V3 FirmwareLoader V 1.0</FirmwareLoader>
  <InternalSensors>
    <Sensor id = 'Temperature'>
      <type>temperature-1</type>
      <SerialNumber>03732345</SerialNumber>
    </Sensor>
    <Sensor id = 'Conductivity'>
      <type>conductivity-1</type>
      <SerialNumber>03732345</SerialNumber>
    </Sensor>
    <Sensor id = 'Pressure'>
      <type>strain-0</type>
      <SerialNumber>2478619</SerialNumber>
    </Sensor>
    <Sensor id='Oxygen'>
      <type>oxygen-1</type>
      <SerialNumber>0439</SerialNumber>
    </Sensor>
  </InternalSensors>
</HardwareData>
```

**Help**

Display list of currently available commands, which may be useful if you do not have access to the HydroCAT manual. Command list depends on logging state. Many commands are not available while HydroCAT is sampling autonomously or waiting to start autonomous sampling (**StartLater** has been sent).

---

**Status Commands** (*continued*)
 

---

**Notes:**

- The **DS** response contains similar information as the combined responses from **GetSD** and **GetCD**, but in a different format.
- Lines describing what parameters to output (temperature, conductivity, pressure, oxygen, salinity, sound velocity, specific conductivity, sample number) only appear if they are enabled, and if **OutputFormat=1, 2, or 3**. Raw output (**OutputFormat=0**) is not affected by enabling / disabling parameter outputs.

**DS**

Display operating status and setup.

List below includes, where applicable, command used to modify parameter.

- Firmware version, serial number, date and time [**DateTime=**].
- Main battery pack voltage and back-up lithium cell voltage.
- Number of samples in memory [**SampleNumber=**] and available sample space in memory.
- Logging status (logging not started, logging data, not logging, or unknown).
- Interval between samples for autonomous sampling [**SampleInterval=**].
- Output data format [**OutputFormat=**].
- Output temperature [**OutputTemp=**]? Temperature units [**SetTempUnits=**]
- Output conductivity [**OutputCond=**]? Conductivity and specific conductivity units [**SetCondUnits=**]
- Output pressure [**OutputPress=**]? Pressure units [**SetPressUnits=**]
- Output oxygen [**OutputOx=**]? Oxygen units [**SetOxUnits=**]
- Output salinity [**OutputSal=**]? Factory-set salinity units (psu)
- Output sound velocity [**OutputSV=**]? Factory-set sound velocity units (m/s)
- Output specific conductivity [**OutputSC=**]? Conductivity and specific conductivity units [**SetCondUnits=**]
- Specific conductivity temperature coefficient [**UseSCDefault=** and **SetSCA=**]
- Transmit sample number with real-time autonomous data and polled data from memory [**TxSampleNum=**]?
- Transmit autonomous data real-time [**TxRealTime=**]?
- Reference pressure to use in calculations if no pressure sensor installed (only sent if pressure sensor not installed) [**ReferencePressure=**].
- Minimum conductivity frequency for pump turn-on [**MinCondFreq=**].
- Adaptive pump control enabled [**AdaptivePumpControl=**]? If not enabled, pump-on time for each measurement displays (only sent if oxygen installed) [**OxNTau \* OxTau20**].
- Pump time multiplier [**OxNTau=**] (only sent if oxygen installed)
- SDI-12 address [**SetAddress=**].
- Out of range value for **OutputFormat=3** and SDI-12 communications [**SetSDI12Flag=**]

---

**Status Commands** *(continued)*

---

*Example:* HydroCAT with pressure and oxygen sensors (user input in bold, command used to modify parameter in parentheses).

**DS**

HydroCAT-SDI12 V2.13.0 SERIAL NO. 32345 31 Oct 2015 10:55:45	[DateTime=]
vMain = 13.31, vLith = 3.19	
samplenum = 0, free = 559240	[SampleNumber=]
not logging, stop command	
sample interval = 300 seconds	[SampleInterval=]
data format = converted engineering	[OutputFormat=]
output temperature, Celsius	[OutputTemp=, SetTempUnits=]
output conductivity, $\mu\text{S}/\text{m}$	[OutputCond=, SetCondUnits=]
output pressure, PSI	[OutputPress=, SetPressUnits=]
output oxygen, mg/L	[OutputOx=, SetOxUnits=]
output salinity, PSU	[OutputSal=, factory-set units]
output sound velocity, m/s	[OutputSV=, factory-set units]
output specific conductivity, $\mu\text{S}/\text{m}$	[OutputSC=, SetCondUnits=]
specific conductivity coefficient = 0.0200	[UseSCDefault= and SetSCA=]
output sample number	[TxSampleNum=]
transmit real time data = yes	[TxRealTime=]
minimum conductivity frequency = 3000.00	[MinCondFreq=]
adaptive pump control enabled	[AdaptivePumpControl=]
nTau = 7.0	[OxNTau=]
SDI-12 address = 0	[SetAddress=]
SDI-12 flag = +9999999	[SetSDI12Flag=]

**Notes:**

- The **DC** and **GetCC** responses contain the same information, but in different formats.
- Dates shown are when calibrations were performed.

**Status Commands** (*continued*)**DC**

Display calibration coefficients, which are initially factory-set and should agree with Calibration Certificates shipped with HydroCAT. Optional oxygen sensor calibration coefficients in response are coefficients programmed into integrated Hydro-DO.

*Example:* HydroCAT with a pressure and oxygen sensors (user input in bold, command used to modify parameter in parentheses).

**DC**

HydroCAT-SDI12 V2.13.0 32345

temperature: 04-Aug-15

TA0 = 6.947802e-05

TA1 = 2.615233e-04

TA2 = -1.265233e-06

TA3 = 1.310479e-07

conductivity: 04-Aug-15

G = -1.036689e+00

H = 1.444342e-01

I = -3.112137e-04

J = 3.005941e-05

CPCOR = -9.570001e-08

CTCOR = 3.250000e-06

WBOTC = 1.968100e-05

pressure S/N 2478619, range = 2901 psia, 03-Aug-15

PA0 = 0.000000e+00

PA1 = 0.000000e+00

PA2 = 0.000000e+00

PTCA0 = 0.000000e+00

PTCA1 = 0.000000e+00

PTCA2 = 0.000000e+00

PTCB0 = 0.000000e+00

PTCB1 = 0.000000e+00

PTCB2 = 0.000000e+00

PTEMPA0 = 0.000000e+00

PTEMPA1 = 0.000000e+00

PTEMPA2 = 0.000000e+00

POFFSET = 0.000000e+00

oxygen S/N 12, 28-Aug-15

TAU\_20 = 4.000000e+00

OXA0 = 1.051300e+00

OXA1 = -1.500000e-03

OXA2 = 4.161926e-01

OXB0 = -2.325492e-01

OXB1 = 1.692931e+00

OXC0 = 8.966704e-02

OXC1 = 3.617471e-03

OXC2 = 5.112384e-05

OXTA0 = 6.517293e-04

OXTA1 = 2.533749e-04

OXTA2 = 3.140482e-07

OXTA3 = 1.064506e-07

OXE = 1.100000e-02

[TCalDate=]

[TA0=]

[TA1=]

[TA2=]

[TA3=]

[CCalDate=]

[CG=]

[CH=]

[CI=]

[CJ=]

[CPCor=]

[CTCor=]

[CWBOTC=]

[PRange= (psi), PCalDate=]

[PA0=]

[PA1=]

[PA2=]

[PTCA0=]

[PTCA1=]

[PTCA2=]

[PTCB0=]

[PTCB1=]

[PTCB2=]

[PTempA0=]

[PTempA1=]

[PTempA2=]

[POffset= (decibars)]

[OxCalDate=]

[OxTau20=]

[OxA0=]

[OxA1=]

[OxA2=]

[OxB0=]

[OxB1=]

[OxC0=]

[OxC1=]

[OxC2=]

[OxTA0=]

[OxTA1=]

[OxTA2=]

[OxTA3=]

[OxE=]

---

**General Setup Commands**

---

**DateTime=mmddyyyyhhmmss** Set real-time clock month, day, year, hour, minute, second.

*Example:* Set current date and time to 10 November 2015 12:00:00 (user input in bold).  
**DATE TIME=11102015120000**

**Notes:**

- The HydroCAT baud rate (set with **BaudRate=**) must be the same as the terminal program's baud rate.
- **BaudRate=** must be sent twice. After the first entry, the HydroCAT changes to the new baud, and then waits for the command to be sent again at the new baud. This prevents you from accidentally changing to a baud that is not supported by your computer. If it does not receive the command again at the new baud, it reverts to the previous baud rate.
- 1200 baud is used for SDI-12 communication, and is independent of baud set for RS-232 communication.

**BaudRate=x**

x= baud rate for **RS-232** communication (4800, 9600, 19200, 38400, 57600, or 115200). Default 19200. Check capability of computer and terminal program before increasing baud; high baud requires a short cable and good PC serial port with accurate clock. **Command must be sent twice to change rate.** Length of cable that HydroCAT can drive for RS-232 communication is dependent on baud. See *Real-Time Data Acquisition*.

**ReferencePressure=x**

x = reference pressure (gauge) in decibars. HydroCAT without pressure sensor uses this in conductivity, oxygen, specific conductivity, salinity, and sound velocity calculations, and in *Adaptive Pump Control* algorithm. Entry ignored if pressure sensor installed.

**\*Default****Reset to defaults for user-input settings.**

- Logging status is 'never started'
- **InitLogging**
- **ResetEC**
- **ReferencePressure=0.0** (if pressure not installed)
- **OutputExecutedTag=Y**
- **TxRealTime=Y**
- **SetAddress=0**
- **SetSDI12Flag=+9999999**
- **AdaptivePumpControl=Y** (if oxygen installed)
- **TxSampleNum=N**
- **OutputFormat=1** (decimal, engineering units)
- **OutputTemp=Y**
- **SetTempUnits=0** (°C)
- **OutputPress=Y** (if pressure installed)
- **SetPressUnits=0** (decibars)
- **OutputSC=Y**
- **SetSCA=0.020**.
- **SetCondUnits=2** (µS/cm)
- **OutputOx=Y** ( if oxygen installed)
- **SetOxUnits=1** (mg/l)
- **OutputCond=N**
- **OutputSal=N**
- **OutputSV=N**
- **SampleInterval=60**

**Note:**

The HydroCAT automatically enters quiescent state after 2 minutes without receiving a command. This timeout algorithm is designed to conserve battery pack energy if the user does not send **QS** to put the HydroCAT to sleep.

**QS**

Quit session and place HydroCAT in quiescent (sleep) state. Main power is turned off. Data logging and memory retention are not affected.



---

**RS-232 Setup Commands**

---

These commands are not applicable for SDI-12 communications. Executed tags and real-time autonomous sampling data are never output for SDI-12 communications.

**OutputExecutedTag=x**      **x=Y**: Display XML Executing and Executed tags for **RS-232** communications. Executed tag displays at end of each command response; Executing tag displays one or more times if HydroCAT response to command requires additional time.

**x=N**: Do not.

*Example:* Set to output Executed and Executing tags (user input in bold).

```
outputexecutedtag=y
<Executed/>getcd
. . . (GetCD response)
<Executed/>
(Note: <Executed/> tag at end of command response takes place of S> prompt.)
```

**Notes:**

- The HydroCAT always outputs real-time data for polled sampling.
- **TxRealTime=** does not affect storing data to memory, but slightly increases current consumption and time needed to sample (and then transmit) data.
- To capture real-time data to a file, use the Capture utility in your terminal program.

**TxRealTime=x**      **x=Y**: Output real-time data for **RS-232** communications while sampling autonomously. Data is transmitted immediately after it is sampled.

**x=N**: Do not output real-time data.

---

**SDI-12 Setup Commands**

---

**SetAddress=x**      **x**= address (0-9, a-z, A-Z) for **SDI-12** communications. **Command must be sent twice to change address.**

**SetSDI12Flag=x**      **x**= out-of-range value (-9999999 to +9999999; must include + or - sign) for **SDI-12** communications (**OutputFormat=3**). **Default +9999999**. If HydroCAT calculates data that is out of range for a particular parameter, this value is inserted in data stream for that parameter.

*Out-of-range* value is not applicable if **OutputFormat=0, 1, or 2**; it is factory set to *nan*.

---

**Pump Setup Commands**

---

**Note:**

See *Pump Operation* in *Section 2: Description of HydroCAT* for details.

The HydroCAT's integral pump is water lubricated; running it *dry* for an extended period of time will damage it. To prevent the pump from running dry while sampling, the HydroCAT checks the raw conductivity frequency (Hz) from the last sample against the user-input minimum conductivity frequency (**MinCondFreq=**). If the raw conductivity frequency is greater than **MinCondFreq**, it runs the pump before taking the sample; otherwise it does not run the pump.

If the minimum conductivity frequency is too close to the *zero conductivity frequency* (from the HydroCAT Calibration Sheet), the pump may turn on when the HydroCAT is in air, as a result of small drifts in the electronics. Some experimentation may be required to control the pump, particularly in fresh water applications.

**MinCondFreq=x**

x= minimum conductivity frequency (Hz) to enable pump turn-on, to prevent pump from running before HydroCAT is in water. Pump does not run when conductivity frequency drops below **MinCondFreq=**. HydroCAT Configuration Sheet lists uncorrected (raw) frequency output at 0 conductivity.

Typical value (and factory-set default) for salt water and estuarine applications:  
(zero conductivity frequency + 500 Hz).

Typical value for fresh water applications:  
(zero conductivity frequency + 5 Hz).

**Note:**

**OxTau20=** is the Hydro-DO sensor response time. If Adaptive Pump Control is turned off, the pump runs for a multiple [**OxNTau=**] of the response time before each sample.

**AdaptivePumpControl=x**

x=Y: If oxygen sensor installed, run pump before each sample based on *Adaptive Pump Control*. Run pump for **OxNTau \* OxTau20 \* ft \* fp**. **Default**.

x=N: If oxygen sensor installed, do not use *Adaptive Pump Control*; run pump for [**OxNTau \* OxTau20**] before each sample. **Adaptive Pump Control should be disabled only for testing and calibration.**

*Example:* If **AdaptivePumpControl=N**, **OxTau20=4.0** (sec), and **OxNTau=7.0**, pump will run for 28 sec (= 7.0 \* 4.0) before each sample.

**OxNTau=x**

x= pump time multiplier.  
Range 0 – 100.0; **default 7.0**.

**CAUTION:**

The HydroCAT does not check **MinCondFreq** when you send **PumpOn**; do not run the pump dry. The pump is water lubricated; running it without water will damage it. If briefly testing your system with the **PumpOn** command in dry conditions, orient the HydroCAT to provide an upright U-shape for the plumbing. Then fill the internal plumbing and inside of the pump head with water via the pump exhaust. This will provide enough lubrication to prevent pump damage during brief testing.

**PumpOn**

Turn pump on to test pump or remove sediment from inside plumbing. **Pump runs continuously, drawing current**. Send **PumpOff** to stop. Note that **PumpOn** has no effect on pump operation while sampling.

**PumpOff**

Turn pump off if it was turned on with **PumpOn**. Note that **PumpOff** has no effect on pump operation while sampling.

### Optional Hydro-DO Optical Dissolved Oxygen Sensor Setup Commands

**Notes:**

Command responses output *SBE 063* as the device type because the Hydro-DO is based on Sea-Bird Electronics' SBE 63.

**Note:**

When using the Hydro-DO integrated with a HydroCAT, the following setup in the **Hydro-DO** is required:

- **SetBaud=2400** (factory set; cannot be changed by command through the HydroCAT).
- **SetEcho=1**.
- **SetFormat=1**.
- **SetAvg=1 to 16; recommended value is 2**.
- **SetAutoRun=0**.
- `<TxPwrSave>` in Hydro-DO's **GetSD** or **GetHD** response is 0 (factory set; cannot be changed by command).

**Send63:command**

Command HydroCAT to send **command** to Hydro-DO and receive response; **command** can be any command recognized by Hydro-DO.

*Example:* Send **GetSD** command to Hydro-DO to verify its setup (user input in bold).

**send63:getsd**

Sending SBE63: getsd

-----

getsd

```
<StatusData DeviceType = 'SBE063' SerialNumber = '0012'>
  <FirmwareVersion>3.2.2</FirmwareVersion>
  <LoaderVersion>SBE 63 FirmwareLoader V 1.0</LoaderVersion>
  <CalibrationDate>05535</CalibrationDate>
  <StatusConfig>
    <BaudRate>002400</BaudRate>
    <BlueOnTime>0000001</BlueOnTime>
    <SampleAvg>002</SampleAvg>
    <SampleInterval>00002</SampleInterval>
    <BootDelay>001</BootDelay>
    <OutFormat>01</OutFormat>
    <AnalogGain>2</AnalogGain>
    <AnalogOffset>06</AnalogOffset>
    <Autorun>0</Autorun>
    <BlueTupdate>0</BlueTupdate>
    <SerPause>1</SerPause>
    <Echo>1</Echo>
    <TxPwrSave>0</TxPwrSave>
    <Flags>0x0000</Flags>
  </StatusConfig>
</StatusData>
<Executed/>
```

Commands that can be sent to the Hydro-DO that are applicable to its use when integrated with the HydroCAT are listed below with brief descriptions; see the Hydro-DO manual for details.

<b>GetSD</b>	Get and display Hydro-DO status data.
<b>GetHD</b>	Get and display Hydro-DO hardware data.
<b>GetCC</b>	Get and display Hydro-DO calibration coefficients
<b>SetBaud=2400</b>	Required Hydro-DO setting for use with HydroCAT.
<b>SetFormat=1</b>	Required Hydro-DO setting for use with HydroCAT.
<b>SetAvg=x</b>	<b>x</b> = number of measurements in Hydro-DO to average per sample; each measurement takes approximately 0.03 sec. Increasing <b>SetAvg=</b> may shorten sensor film life. <b>Required range for use with HydroCAT is 1-16; recommended value 2.</b>
<b>SetAutoRun=0</b>	Required Hydro-DO setting for use with
<b>*Default</b>	Reset most Hydro-DO Setup parameters to factory defaults. Baud ( <b>SetBaud=</b> ) is <b>not</b> reset.
<b>TS</b>	Take <b>1</b> Hydro-DO sample, transmit data in format defined by Hydro-DO's <b>SetFormat=</b> .
<b>TSR</b>	Take <b>1</b> Hydro-DO sample, transmit data in raw format (for factory diagnostics).

**Notes:**

- The HydroCAT pump does not run when **TS** or **TSR** is sent to the Hydro-DO. If desired, use **PumpOn** and **PumpOff** to turn the pump on and off.
- **Converted data in the Hydro-DO response to Send63:TS is based on the calibration coefficients programmed into the Hydro-DO.**

**Notes:**

- If the FLASH memory is filled to capacity, sampling continues, but excess data is not saved in memory (i.e., the HydroCAT does not overwrite the data in memory).
- The HydroCAT requires verification when **InitLogging** or **SampleNumber=** are sent. The HydroCAT responds with a request to repeat the command to confirm. Type the command again and press the Enter key to proceed.
- **Do not send InitLogging or SampleNumber=0 until all data has been uploaded.** These commands do not delete the data; they just reset the data pointer. **If you accidentally send one of these commands before uploading,** recover the data as follows:
  1. Set **SampleNumber=x**, where **x** is your estimate of number of samples in memory.
  2. Upload data. If **x** is more than actual number of samples in memory, data for non-existent samples will be bad, random data. Review uploaded data file carefully and delete any bad data.
  3. If desired, increase **x** and upload data again, to see if there is additional valid data in memory.

**Memory Setup Commands****InitLogging**

Initialize logging – after all previous data has been uploaded, initialize logging before starting to sample again to make entire memory available for recording.

**InitLogging** sets sample number (**SampleNumber=**) to 0 (sampling will start with sample 1). If not set to 0, data will be stored after last recorded sample.

**Do not send InitLogging until all existing data has been uploaded.**

HydroCAT requires this command to be sent twice, to prevent accidental reset of memory.

**SampleNumber=x**

**x**= sample number for last sample in memory. **SampleNumber=0** is equivalent to **InitLogging**. **Do not send SampleNumber=0 until all existing data has been uploaded.**

HydroCAT requires this command to be sent twice, to prevent accidental reset of memory.

---

**Output Format Setup Commands**

---

**Notes:**

- See *Data Formats* after the command descriptions.
- The HydroCAT does not *store* salinity, sound velocity, or specific conductivity in memory when they are enabled. It calculates and outputs these derived parameters in real-time, when polled for data or as data is uploaded; therefore, outputting these parameters has no effect on the number of samples that can be stored in memory.
- The pressure sensor is an absolute sensor, so its **raw** output (**OutputFormat=0**) includes the effect of atmospheric pressure (14.7 psi). However, when outputting pressure in **psi** or **decibars**, the HydroCAT outputs pressure relative to the ocean surface (i.e., at the surface the output pressure is 0 psi or 0 dbar). The HydroCAT uses the following equations to convert psia:  

$$P(\text{psi}) = P(\text{psia}) - 14.7$$

$$P(\text{dbar}) = [P(\text{psia}) - 14.7] * 0.689476$$

<b>OutputFormat=x</b>	<p><b>x=0:</b> output raw decimal data.</p> <p><b>x=1:</b> output converted decimal data.</p> <p><b>x=2:</b> output converted decimal XML data.</p> <p><b>x=3:</b> output converted decimal data in format compatible with SDI-12.            Note: HydroCAT automatically outputs over SDI-12 line in this format; setting <b>OutputFormat=3</b> allows you to view this format with RS-232 communications.</p>
<b>OutputTemp=x</b>	<p><b>x=Y:</b> Output temperature (units defined by <b>SetTempUnits=</b>) with each sample if <b>OutputFormat=1, 2, or 3</b>.</p> <p><b>x=N:</b> Do not.</p>
<b>SetTempUnits=x</b>	<p><b>x=0:</b> Temperature output °C, ITS-90.</p> <p><b>x=1:</b> Temperature output °F, ITS-90.</p>
<b>OutputCond=x</b>	<p><b>x=Y:</b> Output conductivity (units defined by <b>SetCondUnits=</b>) with each sample if <b>OutputFormat=1, 2, or 3</b>.</p> <p><b>x=N:</b> Do not.</p>
<b>SetCondUnits=x</b>	<p><b>x=0:</b> Conductivity and specific conductivity output S/m.</p> <p><b>x=1:</b> Conductivity and specific conductivity output mS/cm.</p> <p><b>2:</b> Conductivity and specific conductivity output µS/cm.</p>
<b>OutputPress=x</b>	<p><b>x=Y:</b> Output pressure (units defined by <b>SetPressUnits=</b>) with each sample if pressure sensor installed and <b>OutputFormat=1, 2, or 3</b>.</p> <p><b>x=N:</b> Do not.</p>
<b>SetPressUnits=x</b>	<p><b>x=0:</b> Pressure output decibars.</p> <p><b>x=1:</b> Pressure output psi (gauge).</p>
<b>OutputOx=x</b>	<p><b>x=Y:</b> Output oxygen (units defined by <b>SetOxUnits=</b>) with each sample if oxygen sensor installed and <b>OutputFormat=1, 2, or 3</b>.</p> <p><b>x=N:</b> Do not.</p>
<b>SetOxUnits=x</b>	<p><b>x=0:</b> Oxygen output ml/L.</p> <p><b>x=1:</b> Oxygen output mg/L.</p>

---

**Output Format Setup Commands** (*continued*)
 

---

<b>OutputSal=x</b>	<p><b>x=Y:</b> Output salinity (psu) with each sample if <b>OutputFormat=1, 2, or 3.</b></p> <p><b>x=N:</b> Do not.</p>
<b>OutputSV=x</b>	<p><b>x=Y:</b> Output sound velocity (m/sec) using Chen and Millero formula (UNESCO Technical Papers in Marine Science #44) with each sample, if <b>OutputFormat=1, 2, or 3.</b></p> <p><b>x=N:</b> Do not.</p>
<b>OutputSC=x</b>	<p><b>x=Y:</b> Output specific conductivity (units defined by <b>SetCondUnits=</b>) with each sample, if <b>OutputFormat=1, 2, or 3.</b></p> <p><b>x=N:</b> Do not.</p>
<b>UseSCDefault=x</b>	<p><i>Only applicable if <b>OutputSC=Y.</b></i></p> <p><b>x=0:</b> Use value specified by <b>SetSCA=.</b></p> <p><b>x=1:</b> Use default value of 0.020 for thermal coefficient of conductivity for natural salt ion solutions (used in specific conductivity calculation).</p>
<b>SetSCA=x</b>	<p><i>Only applicable if <b>OutputSC=Y and UseSCDefault=0.</b></i></p> <p><b>x=</b> thermal coefficient of conductivity for natural salt ion solutions (used in specific conductivity calculation).</p>
<b>TxSampleNum=x</b>	<p><b>x=Y:</b> Output sample number with each <i>polled</i> sample if <b>OutputFormat=1, 2, or 3.</b></p> <p><b>x=N:</b> Do not.</p>

**Note:**

Specific conductivity  
 $= C / (1 + A * [T - 25])$

where

- C = conductivity (same units as specific conductivity:  $\mu\text{S/cm}$ ,  $\text{mS/cm}$ , or  $\text{S/m}$ )
- T = temperature ( $^{\circ}\text{C}$ )
- A = thermal coefficient of conductivity for natural salt ion solutions (default 0.020).

---

**Autonomous Sampling (Logging) Commands**

---

Logging commands direct the HydroCAT to sample data at pre-programmed intervals and store the data in its FLASH memory. Pump operation is dependent on the setting for **MinCondFreq=** (see *Pump Operation* in *Section 2*).

**Notes:**

- Autonomous sampling is not compatible with SDI-12 operation.
- If the HydroCAT is logging data and the battery pack voltage is less than 7.1 volts for five consecutive scans, the HydroCAT halts logging.
- If the FLASH memory is filled to capacity, sampling continues but excess data is not saved in memory (i.e., the HydroCAT does not overwrite the data in memory).

**SampleInterval=x**

**x=** interval (sec) between samples (6 – 21,600). When commanded to start sampling with **StartNow** or **StartLater**, at **x** sec intervals HydroCAT takes measurement (running pump before each measurement), stores data in FLASH memory, transmits real-time data (if communicating via RS-232 and **TxRealTime=Y**), and goes to sleep. Note: Do not set **SampleInterval=** to less than (pumping time + sampling time + 5 sec); see *Pump Operation* in *Section 2: Description of HydroCAT* for details

**StartNow**

Start logging now, at rate defined by **SampleInterval=**. Data is stored in FLASH memory. Data is transmitted real-time if connected via RS-232 and **TxRealTime=Y**.

**Notes:**

- After receiving **StartLater**, the HydroCAT displays `not logging: start at` in reply to **DS**. Once logging has started, the reply displays `logging`.
- If the delayed start date and time has already passed when **StartLater** is received, the HydroCAT executes **StartNow**.
- If the delayed start date and time is more than 30 days in the future when **StartLater** is received, the HydroCAT assumes that the user made an error in setting the delayed start date and time, and it executes **StartNow**.

**StartDateTime=mmddyyyyhhmmss**

Set delayed logging start month, day, year, hour, minute, second.

**StartLater**

Start logging at time set with delayed start date and time command, at rate defined by **SampleInterval**. Data is stored in FLASH memory. Data is transmitted real-time if **TxRealTime=Y**. If you need to change HydroCAT setup after **StartLater** has been sent (but before logging has started), send **Stop**, change setup as desired, and then send **StartLater** again.

*Example:* Program HydroCAT to start logging on 20 September 2015 12:00:00 (user input in bold).

```
STARTDATETIME=09202015120000
STARTLATER
```

**Note:**

You may need to send **Stop** several times to get the HydroCAT to respond. This is most likely to occur if sampling with a small **SampleInterval** and transmitting real-time data (**TxRealTime=Y**).

**Stop**

Stop logging (started with **StartNow** or **StartLater**) or stop waiting to start logging (if **StartLater** was sent but logging has not begun yet). Connect to HydroCAT (before entering **Stop**. **Stop** must be sent before uploading data from memory.

---

**Polled Sampling Commands**

---

These commands are used to request 1 or more samples from the HydroCAT. Unless noted otherwise, the HydroCAT does **not** store the data in FLASH memory.

**Note:**

See *Pump Operation* in Section 2: *Description of HydroCAT* for details.

For polled sampling commands that run the pump (**TPS**, **TPSS**, **TPSN:x**), pump operation is dependent on the conductivity frequency from the last sample, and the setting for **MinCondFreq**=. If the oxygen sensor is installed, pump operation is also dependent on **AdaptivePumpControl**=, and on the temperature and pressure of the previous sample, as described in *Pump Operation* in Section 2: *Description of HydroCAT*.

<b>TS</b>	<b>Do not pump.</b> Take sample, store data in buffer, output data.
<b>TSR</b>	<b>Do not pump.</b> Take sample, store data in buffer, output data in raw decimal format (regardless of <b>OutputFormat</b> =).
<b>TPS</b>	Run pump, take sample, store data in buffer, output data.
<b>TPSS</b>	Run pump, take sample, store data in buffer and <b>FLASH memory</b> , output data. Note: HydroCAT ignores this command if sampling data ( <b>StartNow</b> or <b>StartLater</b> has been sent).
<b>TSN:x</b>	<b>Do not pump.</b> Take x samples and output data. To interrupt, press Esc key. Note: HydroCAT ignores this command if sampling data ( <b>StartNow</b> or <b>StartLater</b> has been sent).
<b>TPSN:x</b>	Run pump <b>continuously</b> while taking x samples and outputting data. To interrupt this sampling, press Esc key. Note: HydroCAT ignores this command if sampling data ( <b>StartNow</b> or <b>StartLater</b> has been sent).
<b>SL</b>	Output last sample stored in buffer.

**Note:**

The HydroCAT has a buffer that stores the most recent data sample. Unlike data in the FLASH memory, data in the buffer is erased upon removal or failure of power.



---

**Data Upload** Commands

---

Stop sampling (send **Stop**) before uploading data.

**GetSamples:b,e**

Upload data from scan **b** to scan **e**,  
in format defined by **OutputFormat=**.  
First sample is number 1. As data is  
uploaded, screen first displays  
start time =  
start sample number =  
These are start time and starting sample  
number for requested data.  
Maximum of 5000 samples can be  
uploaded at one time.

*Example:* Upload samples 1 to 200 to a file (user input in bold).  
(Click Capture menu and enter desired filename in dialog box)

**GETSAMPLES : 1 , 200**

---

**Calibration Coefficients Commands**

---

Calibration coefficients are initially factory-set and should agree with Calibration Certificates shipped with the HydroCAT.

**Note:**

F = floating point number  
S = string with no spaces

*Temperature*

**TCalDate**=S S=Temperature calibration date.  
**TA0**=F F=Temperature A0.  
**TA1**=F F=Temperature A1.  
**TA2**=F F=Temperature A2.  
**TA3**=F F=Temperature A3.

*Conductivity*

**CCalDate**=S S=Conductivity calibration date.  
**CG**=F F=Conductivity G.  
**CH**=F F=Conductivity H.  
**CI**=F F=Conductivity I.  
**CJ**=F F=Conductivity J.  
**WBOTC**=F F=Conductivity wbotc.  
**CTCor**=F F=Conductivity ctcor.  
**CPCor**=F F=Conductivity cpcor.

*Pressure*

**PCalDate**=S S=Pressure calibration date.  
**PA0**=F F=Pressure A0.  
**PA1**=F F=Pressure A1.  
**PA2**=F F=Pressure A2.  
**PTCA0**=F F=Pressure ptca0.  
**PTCA1**=F F=Pressure ptca1.  
**PTCA2**=F F=Pressure ptca2.  
**PTCB0**=F F=Pressure ptcb0.  
**PTCB1**=F F=Pressure ptcb1.  
**PTCB2**=F F=Pressure ptcb2.  
**PTempA0**=F F=Pressure temperature a0.  
**PTempA1**=F F=Pressure temperature a1.  
**PTempA2**=F F=Pressure temperature a2.  
**POffset**=F F=Pressure offset (decibars).

**Note:**

Dissolved oxygen sensor coefficients are also stored separately in the SBE 63.

- **Coefficients stored in the Hydro-DO** are used to output converted oxygen data in response to **Send63:TS** or **T63**. To modify those coefficients, use **Send63:command** to send calibration coefficient commands to the Hydro-DO; see the Hydro-DO manual for those commands.
- **Coefficients stored in the HydroCAT** are used to output converted oxygen data in response to all other commands.

*Dissolved Oxygen*

**OxCalDate**=S S= Oxygen calibration date.  
**OxTau20**=F F= Oxygen Tau20 (sensor response time).  
**OxA0**=F F= Oxygen A0 coefficient.  
**OxA1**=F F= Oxygen A1 coefficient.  
**OxA2**=F F= Oxygen A2 coefficient.  
**OxB0**=F F= Oxygen B0 coefficient.  
**OxB1**=F F= Oxygen B1 coefficient.  
**OxC0**=F F= Oxygen C0 coefficient.  
**OxC1**=F F= Oxygen C1 coefficient.  
**OxC2**=F F= Oxygen C2 coefficient.  
**OxTA0**=F F= Oxygen TA0 coefficient.  
**OxTA1**=F F= Oxygen TA1 coefficient.  
**OxTA2**=F F= Oxygen TA2 coefficient.  
**OxTA3**=F F= Oxygen TA3 coefficient.  
**OxE**=F F= Oxygen E coefficient.

# Appendix IV: AF24173 Anti-Foulant Device

*AF24173 Anti-Foulant Devices supplied for user replacement are supplied in polyethylene bags displaying the following label:*

## AF24173 ANTI-FOULANT DEVICE

FOR USE ONLY IN SEA-BIRD ELECTRONICS' CONDUCTIVITY SENSORS TO CONTROL THE GROWTH OF AQUATIC ORGANISMS WITHIN ELECTRONIC CONDUCTIVITY SENSORS.

### ACTIVE INGREDIENT:

Bis(tributyltin) oxide.....	53.0%
OTHER INGREDIENTS: .....	<u>47.0%</u>
Total.....	100.0%

### DANGER

See the complete label within the Conductivity Instrument Manual for Additional Precautionary Statements and Information on the Handling, Storage, and Disposal of this Product.

Net Contents: Two anti-foulant devices

Sea-Bird Electronics, Inc.  
13431 NE 20<sup>th</sup> Street  
Bellevue, WA 98005

EPA Registration No. 74489-1  
EPA Establishment No. 74489-WA-1

# AF24173 Anti-Foulant Device

FOR USE ONLY IN SEA-BIRD ELECTRONICS' CONDUCTIVITY SENSORS TO CONTROL THE GROWTH OF AQUATIC ORGANISMS WITHIN ELECTRONIC CONDUCTIVITY SENSORS.

**ACTIVE INGREDIENT:**

Bis(tributyltin) oxide.....	53.0%
OTHER INGREDIENTS: .....	47.0%
Total.....	100.0%

**DANGER**

See Precautionary Statements for additional information.

<b>FIRST AID</b>	
If on skin or clothing	<ul style="list-style-type: none"> <li>Take off contaminated clothing.</li> <li>Rinse skin immediately with plenty of water for 15-20 minutes.</li> <li>Call a poison control center or doctor for treatment advice.</li> </ul>
If swallowed	<ul style="list-style-type: none"> <li>Call poison control center or doctor immediately for treatment advice.</li> <li>Have person drink several glasses of water.</li> <li>Do not induce vomiting.</li> <li>Do not give anything by mouth to an unconscious person.</li> </ul>
If in eyes	<ul style="list-style-type: none"> <li>Hold eye open and rinse slowly and gently with water for 15-20 minutes.</li> <li>Remove contact lenses, if present, after the first 5 minutes, then continue rinsing eye.</li> <li>Call a poison control center or doctor for treatment advice.</li> </ul>
<b>HOT LINE NUMBER</b>	
Note to Physician	Probable mucosal damage may contraindicate the use of gastric lavage.
Have the product container or label with you when calling a poison control center or doctor, or going for treatment. For further information call National Pesticide Telecommunications Network (NPTN) at 1-800-858-7378.	

Net Contents: Two anti-foulant devices

Sea-Bird Electronics, Inc.  
 13431 NE 20<sup>th</sup> Street  
 Bellevue, WA 98005

EPA Registration No. 74489-1  
 EPA Establishment No. 74489-WA-1

## PRECAUTIONARY STATEMENTS

### HAZARD TO HUMANS AND DOMESTIC ANIMALS

#### DANGER

**Corrosive** - Causes irreversible eye damage and skin burns. Harmful if swallowed. Harmful if absorbed through the skin or inhaled. Prolonged or frequently repeated contact may cause allergic reactions in some individuals. Wash thoroughly with soap and water after handling.

#### PERSONAL PROTECTIVE EQUIPMENT

##### USER SAFETY RECOMMENDATIONS

Users should:

- Remove clothing immediately if pesticide gets inside. Then wash thoroughly and put on clean clothing.
- Wear protective gloves (rubber or latex), goggles or other eye protection, and clothing to minimize contact.
- Follow manufacturer's instructions for cleaning and maintaining PPE. If no such instructions for washables, use detergent and hot water. Keep and wash PPE separately from other laundry.
- Wash hands with soap and water before eating, drinking, chewing gum, using tobacco or using the toilet.

#### ENVIRONMENTAL HAZARDS

Do not discharge effluent containing this product into lakes, streams, ponds, estuaries, oceans, or other waters unless in accordance with the requirements of a National Pollutant Discharge Elimination System (NPDES) permit and the permitting authority has been notified in writing prior to discharge. Do not discharge effluent containing this product to sewer systems without previously notifying the local sewage treatment plant authority. For guidance contact your State Water Board or Regional Office of EPA. This material is toxic to fish. Do not contaminate water when cleaning equipment or disposing of equipment washwaters.

#### PHYSICAL OR CHEMICAL HAZARDS

Do not use or store near heat or open flame. Avoid contact with acids and oxidizers.

#### DIRECTIONS FOR USE

It is a violation of Federal Law to use this product in a manner inconsistent with its labeling. For use only in Sea-Bird Electronics' conductivity sensors. Read installation instructions in the applicable Conductivity Instrument Manual.

**STORAGE AND DISPOSAL**

**PESTICIDE STORAGE:** Store in original container in a cool, dry place. Prevent exposure to heat or flame. Do not store near acids or oxidizers. Keep container tightly closed.

**PESTICIDE SPILL PROCEDURE:** In case of a spill, absorb spills with absorbent material. Put saturated absorbent material to a labeled container for treatment or disposal.

**PESTICIDE DISPOSAL:** Pesticide that cannot be used according to label instructions must be disposed of according to Federal or approved State procedures under Subtitle C of the Resource Conservation and Recovery Act.

**CONTAINER HANDLING:** Nonrefillable container. Do not reuse this container for any other purpose. Offer for recycling, if available.

# Appendix V: Replacement Parts

Part Number	Part	Application Description	Quantity in HydroCAT
50441	AA Saft Lithium cell set (12)	Power HydroCAT	1
801863	Battery holder for HydroCATs	Holds AA cells	1
801542	AF24173 Anti-Foulant Device	Bis(tributyltin) oxide device inserted into anti-foulant device cup	1 (set of 2)
30411	Triton X-100	Octyl Phenol Ethoxylate – Reagent grade non-ionic cleaning solution for conductivity cell (supplied in 100% strength; dilute as directed)	1
802220	6-pin MCIL-6FS (wet-pluggable connector) to 9-pin DB-9S I/O cable with power leads and leads to SDI-12, 2.4 m (8 ft)	From HydroCAT to computer and/or SDI-12 controller	1
171192	Locking sleeve (wet-pluggable connector)	Locks cable/plug in place	1
171498.1	6-pin MCDC-6-F dummy plug with locking sleeve, wet-pluggable connector	For when cable not used	1
60073	Spare hardware / O-ring kit for HydroCAT	Assorted hardware and O-rings: <ul style="list-style-type: none"> <li>• 30097, O-ring, NAS1611-111A EP (2-111) (exhaust to cell guard seal)</li> <li>• 30174, Machine screw, 10-24 x 9/16 PH, SS (anti-foulant cover retaining screw)</li> <li>• 30498, O-ring, Parker, 2-110 N674-70 (anti-foulant cartridge seal)</li> <li>• 30857, O-ring, NAS1611-033A EP (2-033) (connector end cap O-rings)</li> <li>• 30858, O-ring, Parker 2-133 N674-70 (battery pack end cap O-rings)</li> <li>• 311461, Screw, 10-32 x 7/16" FH Phillips, Titanium (cell guard)</li> <li>• 31322, O-ring, Parker 2-130 N674-70 (battery pack housing O-rings)</li> <li>• 31478, Washer shoulder, #8, Small parts B-WNS-8 (anti-foulant cover retaining screw insulator)</li> <li>• 31513, Cap screw, 8-32 x 5/8" SH, Titanium (secures sensor lift eye)</li> <li>• 31516, Hex key, 9/64" Long arm, DOALL #AHT58010 (tool for opening connector end cap)</li> <li>• 31671, Hex key, 5/32" Long arm, #7122A46 (tool for removing copper anti-foulant assembly)</li> <li>• 31749, Hex key, 7/64" Long arm (tool for battery pack)</li> <li>• 31755, Cap screw, 8-32 x 1/4" SH, Titanium (secures connector end cap to housing)</li> <li>• 31811, Machine screw, 10-24 X 7/8, FH Phillips Titanium (anti-foulant cover retaining screw)</li> </ul>	-

# Appendix VI: Manual Revision History

Manual Version	Date	Description
001-005		<ul style="list-style-type: none"> <li>• Earlier designs, with various options.</li> </ul>
006	05/15	<ul style="list-style-type: none"> <li>• Mechanical redesign.</li> <li>• Create one manual for HydroCAT with or without optional dissolved oxygen sensor; previously these were separate manuals.</li> <li>• Incorporate Universal Coastal Interface (UCI) software, and remove Sea-Bird Electronics software (Seaterm V2, Seaterm232, SBE Data Processing).</li> <li>• Move command descriptions to Appendix III, since most commonly used commands are now sent via UCI.</li> <li>• Update temperature range and accuracy specifications.</li> <li>• Update pressure range (eliminate pressure options deeper than 350 meters).</li> <li>• Update lithium cell and battery language to conform to latest IATA rules.</li> <li>• Add information on 16 V minimum for external voltage, if you want to avoid drawing power from battery pack.</li> <li>• Add caution regarding using Parker Super O Lube, not Parker O Lube (which is petroleum based).</li> <li>• Add caution on using spray can lubricants on MCBH connectors.</li> <li>• Remove references to old locations of documents on Sea-Bird Electronics website.</li> </ul>



# Index

---

## A

Adaptive pump control · 15, 74  
 Anti-Foulant Device · 83  
   removal before shipping to Sea-Bird · 49  
   replacing · 47, 48  
 Autonomous sampling · 28, 79

---

## B

Batteries · 12  
 Battery endurance · 11  
 Battery Endurance Calculator · 24  
 Battery pack · 39  
   description · 22  
   endurance · 17  
   replacing · 46  
   shipping precautions · 9  
 Baud rate · 29, 72  
 Bleed hole · 38

---

## C

Cable length · 29  
 Cables · 14  
 Calibration · 49  
 CE certification · 3  
 Cells  
   description · 22  
   replacing · 46  
 Cleaning · 44  
 Clock · 12, 54  
 Command details · 59  
 Command summary · 59  
 Commands  
   autonomous sampling · 79  
   baud rate · 72  
   calibration coefficients · 82  
   data format · 77  
   data upload · 81  
   date and time · 72  
   descriptions · 29, 30  
   general setup · 72  
   Hydro-DO setup · 75  
   logging · 79  
   memory setup · 76  
   optical dissolved oxygen sensor setup · 75  
   polled sampling · 80  
   pump setup · 74  
   RS-232 setup · 73  
   SDI-12 · 30  
   SDI-12 setup · 73  
   status · 63  
 Conductivity sensor · 54  
   calibration · 49  
   cleaning · 44  
 Connector · 13, 43  
 Corrosion precautions · 43

---

## D

Data format · 33, 34, 77  
 Data upload · 42  
 Date and time · 72  
 Declaration of Conformity · 3  
 Deployment · 38  
   installation · 40  
   preparing for · 22  
   setup · 39  
 Deployment Endurance Calculator · 11, 17  
 Deployment orientation · 11, 13, 40  
 Description · 10  
 Dimensions · 13  
 Dissolved oxygen sensor · 54  
   calibration · 49  
   cleaning · 44

---

## E

Electronics disassembly/reassembly · 55  
 End cap · 43  
 End cap connector · 13  
 External power · *See* Power, external

---

## F

Flooded HydroCAT · 41  
 Format  
   data · 33, 34  
 Functional description · 54

---

## G

Glossary · 53  
 Guard  
   removal · 47, 48

---

## I

Initializing memory · 76

---

## L

Limited liability statement · 2  
 Logging · 28, 79

---

## M

Maintenance · 43  
 Manual revision history · 88  
 Memory · 12  
 Memory setup · 76  
 Minimum conductivity frequency · 15, 74  
 Modes · *See* Sampling modes  
 Mounting · 38

---

**O**

Orientation · 38  
O-ring  
  maintenance · 46  
Output format · 34, 77  
Oxygen sensor · 54  
  calibration · 49  
  cleaning · 44

---

**P**

Parker Super O-Lube · 53  
Parts  
  replacement · 87  
Plastic housing  
  handling · 45  
Polled sampling · 27  
Power  
  endurance · 11  
  external · 12, 20  
Pressure sensor · 54  
  calibration · 50  
  maintenance · 46  
Pump · 11, 12, 13, 26, 38, 40, 79, 80  
  maintenance · 44  
Pump operation · 15  
Pump setup commands · 74

---

**Q**

Quick start · 7

---

**R**

Real-time setup  
  baud rate · 29  
  cable length · 29  
Recovery · 41  
  uploading data · 42  
Replacement parts · 87  
Revision history · 88  
RS-232 output format · 34  
RS-232 setup commands · 73

---

---

**S**

Sample timing · 17  
Sampling modes · 26  
  autonomous · 28, 79  
  logging · 28, 79  
  polled · 27  
SDI-12  
  commands · 30  
  data format · 33  
SDI-12 setup commands · 73  
Seasoft · 11  
Seasoft V2 · 17, 24  
Sediment · 44  
Sensors · 12  
Setup commands · 72  
Shipping precautions · 9  
Software · 11, 24  
Specifications · 12  
Status commands · 63  
Storage · 44  
Super O-Lube · 53  
System description · 10

---

**T**

Temperature sensor · 54  
  calibration · 49  
Terminal program · 11, 24, 25  
Testing · 24  
Thermistor · 54  
Timeout description · 29  
Transient current · 20  
Triton · 53  
Troubleshooting · 51

---

**U**

UCI · 11, 24, 25, 42  
Universal Coastal Interface · 24  
Unpacking HydroCAT · 8  
Uploading data · 42

---

**V**

Versions · 88

---

**W**

Wiring · 14, 24

---