



# 9210B Xlite Data Logger

---

---

## Operations and Maintenance Manual

---

---

Part No. 8800-1172

Rev 3.18

August 14, 2015

Sutron Corporation

22400 Davis Drive

Sterling, Virginia 20164

TEL: (703) 406-2800

FAX: (703) 406-2801

WEB: <http://www.sutron.com/>







































# Table of Contents

























|   |           |
|---|-----------|
| <b>CHAPTER 1: INTRODUCTION.....</b>                       | <b>1</b>  |
| FEATURES.....   | 2         |
| Key Features.....   | 2         |
| Features.....   | 2         |
| HIGHLIGHTS.....   | 3         |
| EzSetup and Graphical Setup – The Key to Flexibility..... | 3         |
| I/O Modules – The Key to Expansion.....                   | 3         |
| DLLs – The Key to Modularity.....                         | 3         |
| PRODUCT DESCRIPTION.....                                  | 4         |
| Models.....   | 5         |
| <b>CHAPTER 2: GETTING STARTED.....</b>                    | <b>7</b>  |
| UNPACKING.....  | 8         |
| Standard Items.....                                       | 8         |
| Common Optional Items.....                                | 8         |
| Other Optional Items.....                                 | 8         |
| INITIAL CHECKOUT.....                                     | 9         |
| Powering Up.....  | 9         |
| Verify Xlite Display Works.....                           | 9         |
| Adjust the Contrast (optional).....                       | 9         |
| Verify XTerm Works.....                                   | 9         |
| Verify I/O Modules Work.....                              | 9         |
| Optional SLL Library.....                                 | 10        |
| PREPARING FOR SET-UP.....                                 | 14        |
| Analyze the System.....                                   | 14        |
| Choosing the Right Block.....                             | 14        |
| How to Select a Completion Resistor.....                  | 15        |
| Using SDI-12 over the RS-485 Port.....                    | 16        |
| Redirecting SDI to COM4.....                              | 16        |
| Using the RS485SDI SLL.....                               | 17        |
| <b>CHAPTER 3: OPERATING THE 9210.....</b>                 | <b>19</b> |
| LOGGING IN.....   | 20        |
| User Access.....  | 20        |
| Tab Overview.....   | 20        |
| MAIN TAB.....   | 21        |
| Date/Time.....  | 21        |
| Station Name.....   | 22        |
| Station Status.....                                       | 22        |
| Battery Voltage.....                                      | 22        |
| Logout.....   | 23        |
| SETUP TAB.....  | 24        |
| Tree Overview.....  | 24        |
| Coms (SSP/CL).....  | 25        |
| COMS (SSP/CL) Setup Menu.....                             | 26        |
| Coms (SSP/CL) Configuration Settings.....                 | 30        |
| EzSetup Measurements.....                                 | 37        |
| Measurement Schedules.....                                | 38        |
| Sensor Configuration.....                                 | 39        |
| Graphical Setup.....                                      | 42        |
| I/O Modules.....  | 43        |
| Naming I/O Modules.....                                   | 44        |
| Reseting I/O Modules.....                                 | 44        |

|                             |    |
|-----------------------------|----|
| LAN Settings .....          | 44 |
| Crossover Connections ..... | 46 |
| Log Files .....             | 46 |
| Log Properties .....        | 46 |
| Satlink .....               | 49 |
| Satlink Dialog .....        | 49 |
| Self-Timed Dialog .....     | 50 |
| Self-Timed Test .....       | 54 |
| Random Test .....           | 55 |
| Satlink Status .....        | 56 |
| Self-test .....             | 56 |
| Setup File .....            | 58 |
| New .....                   | 58 |
| Open .....                  | 58 |
| Save As .....               | 58 |
| Append .....                | 59 |
| Users .....                 | 59 |
| SENSORS TAB .....           | 61 |
| DATA TAB .....              | 63 |
| LOG TAB .....               | 67 |
| Column Labels .....         | 67 |
| Time .....                  | 67 |
| Sensor .....                | 67 |
| Data .....                  | 67 |
| Q .....                     | 68 |
| Units .....                 | 68 |
| Date .....                  | 68 |
| Selecting a Log File .....  | 68 |
| Navigating the Log .....    | 68 |
| +Day, -Day .....            | 68 |
| Find .....                  | 68 |
| Clearing the Log .....      | 68 |
| Entering a NOTE .....       | 68 |
| Export .....                | 69 |
| STATUS TAB .....            | 71 |
| OPERATING THE DISPLAY ..... | 73 |
| Display Status .....        | 73 |
| Display Values .....        | 74 |
| Calibrate .....             | 74 |
| Setup .....                 | 75 |
| Start/Stop Recording .....  | 75 |
| Load SSF From Card .....    | 75 |
| Save SSF to Card .....      | 75 |
| Change Station Name .....   | 75 |
| Change Sensors .....        | 75 |
| Set Time .....              | 76 |
| Exit Setup .....            | 76 |
| View Log Data .....         | 76 |
| Dump Log Data .....         | 76 |
| SDI .....                   | 76 |
| Send Command .....          | 76 |
| Find Sensors .....          | 76 |
| Show Found Sensors .....    | 77 |
| Coms Test .....             | 77 |
| Show SSP Stats .....        | 77 |
| Clear SSP Stats .....       | 77 |







|   |            |
|---|------------|
| Check Mail .....  | 77         |
| Send Mail.....  | 78         |
| Key .....   | 78         |
| UnKey.....  | 78         |
| Edit Basic .....  | 78         |
| Edit Satlink.....   | 78         |
| USING STORAGE CARDS .....                                 | 79         |
| Expand log file capabilities .....                        | 79         |
| Upload/download setups .....                              | 80         |
| Download log files .....                                  | 80         |
| <b>CHAPTER 4: GRAPHICAL SETUP DIAGRAMS .....</b>          | <b>83</b>  |
| OVERVIEW .....  | 84         |
| AN EXAMPLE GRAPHICAL SETUP .....                          | 85         |
| Block Categories .....                                    | 85         |
| Block Inputs and Outputs .....                            | 85         |
| Block Connectability .....                                | 86         |
| Active Blocks and Push/Pull.....                          | 86         |
| Block Placement .....                                     | 87         |
| Block Properties .....                                    | 87         |
| CREATING A NEW GRAPHICAL SETUP.....                       | 89         |
| Adding a Sensor Using the Wizard .....                    | 89         |
| Adding Additional Blocks .....                            | 90         |
| Changing Block Properties.....                            | 92         |
| Sensor Block Example.....                                 | 92         |
| Processing Block Example .....                            | 93         |
| Log Block Example .....                                   | 93         |
| Changing the Block Label .....                            | 94         |
| MODIFYING A GRAPHICAL SETUP DIAGRAM .....                 | 95         |
| Wiring and Unwiring.....                                  | 95         |
| Deleting a Block .....                                    | 97         |
| Deleting Multiple Blocks .....                            | 97         |
| Inserting a Block .....                                   | 98         |
| <b>CHAPTER 5: EXAMPLE SETUPS .....</b>                    | <b>100</b> |
| EZSETUP FOR A STREAM GAUGING STATION.....                 | 101        |
| GRAPHICAL SETUP TO COMPUTE DAILY MIN/MAX.....             | 106        |
| <b>CHAPTER 6: OPERATION WITH A PC RUNNING XTERM .....</b> | <b>108</b> |
| INTRODUCTION.....   | 109        |
| Installing XTerm .....                                    | 109        |
| Automatic Detection of 9210s on a Network .....           | 111        |
| SSP Settings .....  | 111        |
| Redirector Settings .....                                 | 112        |
| Preparing the 9210 to work with XTerm.....                | 113        |
| Operating XTerm .....                                     | 113        |
| File Transfer .....                                       | 115        |
| Process List Folder .....                                 | 116        |
| Set Clock .....   | 117        |
| Connect.....  | 117        |
| Upgrade .....   | 117        |
| Web Server.....   | 117        |
| Auto Update .....   | 118        |
| Station Operations .....                                  | 118        |
| Startup.....  | 118        |
| Shutdown .....  | 118        |

|  |            |
|--|------------|
| Reboot.....  | 118        |
| FireWalls .....  | 118        |
| Configuring the PC modem for use with Xterm.....   | 119        |
| Status and Rx, Tx, Xp, Err indicators.....   | 120        |
| Special Command Line Options.....  | 122        |
| <b>CHAPTER 7: INSTALLATION.....</b>  | <b>123</b> |
| STEPS TO INSTALL A 9210 .....  | 124        |
| USING COM PORTS.....   | 126        |
| Overview .....   | 126        |
| Pin-out information .....  | 126        |
| Jumper Settings .....  | 127        |
| Maximum Current Draw from Com Port Pin 9 .....   | 128        |
| Xlite Com 1 - 4 .....  | 128        |
| Switched power settings .....  | 128        |
| <b>CHAPTER 8: MAINTENANCE AND TROUBLESHOOTING .....</b>  | <b>129</b> |
| COMMON MAINTENANCE AND TROUBLESHOOTING.....  | 130        |
| Skip autoexec.bat.....   | 130        |
| Unit missing functionality .....   | 130        |
| Xterm has a White screen or Black Screen .....   | 130        |
| Adjust the contrast.....   | 130        |
| Replace the Internal Battery every 5 years .....   | 131        |
| Cleaning Instructions.....   | 131        |
| Fuses.....   | 131        |
| <b>APPENDIX A: SETUP BLOCKS.....</b>   | <b>132</b> |
| INTRODUCTION.....  | 133        |
| SENSOR BLOCKS.....   | 134        |
|  Air Temperature Sensor (AirTemp).....            | 134        |
|  Air Temperature/Relative Humidity (AT/RH).....   | 136        |
|  Analog (ADC) .....                               | 137        |
|  Barometric Pressure (BP).....                    | 143        |
|  BEI Absolute Encoder (BEIEnc) .....              | 144        |
|  Binary Input (BinIn).....                        | 145        |
|  Binary Input – All Channels (BinInAllChan) ..... | 147        |
|  Bridge Resistance (Bridge) .....                 | 149        |
|  CapRain (CapRain) .....                          | 150        |
|  Constant (ConstIn).....                          | 152        |
|  Counter (Counter) .....                          | 154        |
|  CS107 Temperature Sensor (CS107Temp) .....       | 156        |

|   |   |     |
|---|---|-----|
|    | Frequency (Freq) .....                          | 158 |
|    | Fuel Moisture (FM) .....                        | 160 |
|    | GetTag .....                                    | 161 |
|    | GillWind (Gill Wind Sensor).....                | 162 |
|    | Heat Flux (HeatFlux) .....                      | 164 |
|    | Internal Battery (IntBat) .....                 | 167 |
|    | Log Input.....                                  | 168 |
|    | ML2x Soil Moisture Sensor (ML2x) .....          | 169 |
|    | MRL 700 Radar Sensor (MRL700) .....             | 170 |
|    | Net Radiometer Sensors (NetRad) .....           | 172 |
|    | Airmar PB200/200WX (PB200).....                 | 175 |
|    | Platinum RTD (PlatRTD) .....                    | 178 |
|   | Quadrature Shaft Encoder.....                   | 180 |
|  | R.M. Young Wind Sensor (RMYoung).....           | 181 |
|  | SDI-12 .....                                    | 183 |
|  | SDI AquaTrak (SDIAqua) .....                    | 184 |
|  | SE8500 (SE8500) .....                           | 185 |
|  | Send Current Time (SendTime).....               | 186 |
|  | Soil Moisture (SoilM).....                      | 187 |
|  | Soil Temperature (SoilTemp) .....               | 189 |
|  | Solar Radiation (SolRad).....                   | 190 |
|  | Submersible Pressure Transducer (SubPres) ..... | 192 |
|  | Tipping Bucket Sensor (Precip).....             | 193 |
|  | Volt Meter (VoltMeter) .....                    | 196 |
|  | Vibrating Wire (VWire).....                     | 197 |
|   | PROCESSING BLOCKS .....                         | 198 |

|   |  |     |
|---|--|-----|
|    | Alarm .....  | 198 |
|    | Accumulator (Accum) .....                          | 200 |
|    | Average (Average) .....                            | 201 |
|    | Bool (Boolean) .....                               | 203 |
|    | CS625 Water Content Reflectometer (CS625WCR) ..... | 204 |
|    | Dew Point (DewPt) .....                            | 206 |
|    | DQAP (Quality-Controlled Average) .....            | 207 |
|    | Interpolate (Interpolate) .....                    | 209 |
|    | Georgia Pacific Sampler (GPSmpl) .....             | 211 |
|    | Measure (Measure) .....                            | 212 |
|    | Minimum/Maximum (MinMax) .....                     | 213 |
|   | Moving Average (MovingAverage) .....               | 214 |
|  | Polynomial (Poly) .....                            | 215 |
|  | PtCtrl (Point Control) .....                       | 216 |
|  | Set Point Control (SetPoint) .....                 | 218 |
|  | Solar Radiation Accumulator (SRAcc) .....          | 219 |
|  | Vector Average (VectAvg) .....                     | 221 |
|  | Wave Processor (WavProc) .....                     | 223 |
|  | XY Function (XYFunc) .....                         | 228 |
|   | LOGGING BLOCKS .....                               | 229 |
|  | Log .....  | 229 |
|  | LogField .....                                     | 231 |
|  | LogRec .....                                       | 233 |
|  | WebLog .....                                       | 236 |
|   | TELEMETRY BLOCKS .....                             | 237 |
|  | Coms Tag .....                                     | 237 |



|   |  |            |
|---|--|------------|
|  | Random Group (RndGroup) .....          | 239        |
|  | Random Parameter (Random) .....        | 241        |
|  | Self-Timed Parameter (SelfTimed) ..... | 242        |
| OUTPUT BLOCKS .....   |  | 247        |
|  | Binary Out (BinOut) .....              | 247        |
|  | Pulse Out (PulseOut).....              | 248        |
|  | Send Tag.....                          | 249        |
| MISCELLANEOUS BLOCKS .....  |  | 250        |
|  | Display (Display).....                 | 250        |
| <b>APPENDIX B: UPDATING THE FIRMWARE .....</b>                                    |  | <b>253</b> |
| UPDATING THE FIRMWARE .....   |  | 254        |
| Serial/Ethernet Upgrade .....   |  | 254        |
| Customizing a Serial/Ethernet Upgrade.....  |  | 255        |
| Storage Card Upgrade (SD or USB).....   |  | 258        |
| Customizing a Storage Card Upgrade.....   |  | 258        |
| Manual Component Upgrade.....   |  | 259        |
| Upgrade the Boot Loader.....  |  | 259        |
| Upgrade the Kernel.....   |  | 259        |
| Upgrade the Application.....  |  | 260        |
| <b>APPENDIX C: I/O MODULES .....</b>  |  | <b>261</b> |
| XLITE ANALOG MODULE – “A” TERMINAL STRIP .....                                    |  | 262        |
| XLITE DIGITAL MODULE – “B” TERMINAL STRIP.....                                    |  | 264        |
| Features .....  |  | 265        |
| Inputs .....  |  | 265        |
| Frequency .....   |  | 266        |
| Shaft encoders .....  |  | 266        |
| Outputs .....   |  | 266        |
| ADD ON ANALOG I/O MODULE – 8080-0003 .....  |  | 267        |
| Features .....  |  | 267        |
| Specifications .....  |  | 268        |
| Operational States.....   |  | 269        |
| Running .....   |  | 269        |
| Stopped.....  |  | 269        |
| Inputs/Outputs .....  |  | 269        |
| Inputs .....  |  | 269        |
| Outputs .....   |  | 269        |
| Analog Measurements .....   |  | 269        |
| Accuracy.....   |  | 270        |
| Example Configurations Using the 8080-0003 Analog I/O Module .....                |  | 271        |
| ADD ON ANALOG I/O MODULE – 8080-0007 .....  |  | 272        |
| Features .....  |  | 272        |
| Transient Protection Installation Note .....                                      |  | 272        |
| Specifications .....  |  | 273        |
| Example Configurations Using the 8080-0007 Analog I/O Module .....                |  | 274        |
| ADD ON DIGITAL I/O MODULE – 8080-0002.....  |  | 275        |
| Inputs .....  |  | 276        |

|  |            |
|--|------------|
| Outputs .....  | 277        |
| <b>APPENDIX D: SPECIFICATIONS.....</b>                 | <b>278</b> |
| 9210-0000-2B Xlite.....                                | 279        |
| Main board.....  | 279        |
| RS232 Modules .....                                    | 279        |
| Speech Modem .....                                     | 279        |
| LOS Radio .....  | 280        |
| Satlink Transmitter .....                              | 280        |
| <b>APPENDIX E: SOFTWARE DEVELOPMENT KIT (SDK).....</b> | <b>281</b> |
| OVERVIEW .....   | 282        |
| <b>APPENDIX F: CREATING CUSTOM VOICE FILES .....</b>   | <b>283</b> |
| OVERVIEW .....   | 284        |
| <b>APPENDIX G: AUTOEXEC.BAT AND REMOTE.EXE .....</b>   | <b>285</b> |
| OVERVIEW .....   | 286        |
| Autoexec.bat.....                                      | 286        |
| Remote.exe.....  | 286        |
| ABOUT Command Example.....                             | 296        |
| Get Command Example.....                               | 296        |
| INFO command Example .....                             | 297        |
| MAIL Command Example .....                             | 298        |
| MEASURE/SHOW Command Example.....                      | 298        |
| PASSTHRU Command Example .....                         | 299        |
| RECORDING Command Example .....                        | 299        |
| SET Command Example .....                              | 299        |
| SHUTDOWN Command Example.....                          | 299        |
| STARTUP Command Example.....                           | 299        |
| STATION Command Example .....                          | 299        |
| STATUS Command Example .....                           | 300        |
| UPGRADE Command Example.....                           | 300        |
| YMODEM Command Example .....                           | 300        |
| <b>APPENDIX H: SATLINK TX FORMATS.....</b>             | <b>301</b> |
| RANDOM TRANSMISSION PSEUDOBINARY DATA FORMAT .....     | 302        |
| SCHEDULED PSEUDOBINARY DATA FORMAT .....               | 306        |
| SCHEDULED SHEF DATA FORMAT .....                       | 308        |
| SIX-BIT BINARY ENCODED FORMAT .....                    | 310        |
| ASCII COLUMN FORMAT .....                              | 311        |
| ASCII SENSOR FORMATTING .....                          | 312        |
| DATA RECEIVED THROUGH DAPS.....                        | 313        |
| <b>APPENDIX I: DIMENSIONS .....</b>                    | <b>315</b> |
| XLITE DATA LOGGER .....                                | 316        |
| EXTERNAL I/O MODULES .....                             | 317        |
| EXTERNAL MODEM .....                                   | 318        |

# **Chapter 1: Introduction**

# FEATURES

---

Sutron's 9210 is designed to be the heart of a wide range of remote monitoring and control systems. The 9210 is a highly modular design that is scalable to handle simple to complex requirements.

## Key Features

Intuitive, EzSetup and a graphical block-oriented setup.

Unlimited expansion with I/O Modules.

Software extensibility with DLL libraries.

## Features

Built-in high performance, 10 channel, 16 bit A/D module

Built-in 8 channel digital module

Built-in 2 line backlit LCD display with 3 navigation buttons.

USB and SD card support for log memory expansion.

Multiple, independent log files. Changes to setup do not affect logged data.

Modular design – build the logger from modules offered by Sutron.

Expandable – additional modules can be added as needed.

Scalable – handles simple as well as complex sites.

Low power consumption – sleep modes with low quiescent power, low operating power.

Battery operated – each module operates off of 10 to 16 VDC.

Wide temperature operation – -40 to +60C.

High reliability and robust – no fuses, fault tolerant, lightning protection.

Multiple telemetry – can add telephone, LOS Radio, GOES, METOESAT telemetry.

Plug-n-play ease of setup – the system is setup with ease. Install a new module, and the system automatically detects it and allows it to be configured for operation.

Flexible measuring and recording – The setup allows separate measuring schedules for data as well as individual recording intervals.

Open design – the system will operate with sensors and modules manufactured by others.

Takes measurements from low cost sensors.

High-speed data transfers – data downloads to PC at 115k baud.

Time accuracy of ten seconds per month over full temperature range.

## HIGHLIGHTS

---

### EzSetup and Graphical Setup – The Key to Flexibility

A unique part of the design is the ability to use the EzSetup and/or the graphical block-oriented setup. Many simple measurements are quickly setup using EzSetup, for even more flexibility the graphical setup blocks of various types are connected together to graphically represent data flow from all sensors, with data flowing from left to right. An example EzSetup is shown below on the left and a graphical setup is shown below on the right.

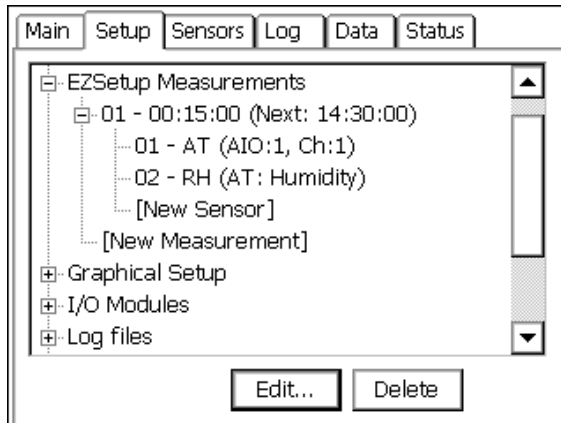

EzSetup Measurements

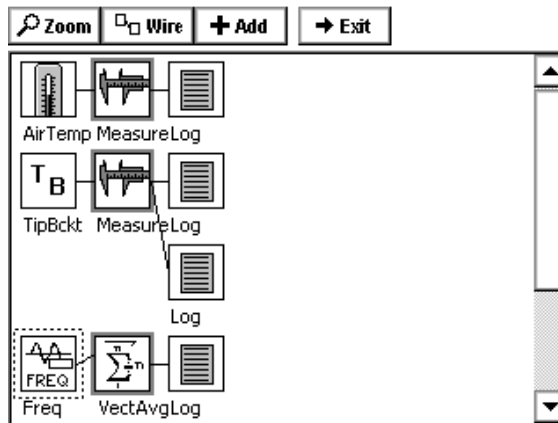

Graphical Setup

### I/O Modules – The Key to Expansion

The 9210 epitomizes the concept of expandability. By itself, the 9210 has a built-in 10 channel, 16 bit A/D, an 8 channel digital module, a SDI-12 v1.3 port, three RS-232 ports and one RS-232/RS485 port. If this isn't sufficient, connect external analog or digital modules using the I2C port. Support for a nearly unlimited number of analog and digital I/O modules makes sure running out of I/O is never an issue.

### DLLs – The Key to Modularity

The software is modular and utilizes Windows DLLs (Dynamic Linked Libraries). DLLs are additional software components that can be added to the system at any time without having to update the main software. This makes adding features that were not available when the unit was purchased easy - simply download the new DLL from the Sutron web page, and send it to the 9210. This might be done, for example, to add support for a new sensor, or to add some newly released communication capability to the unit. Some customers can even create their own DLLs using Microsoft Visual C++ and a Software Development Kit (SDK) provided by Sutron.

## PRODUCT DESCRIPTION

The 9210 data acquisition platform is based on a 32 bit microprocessor, running the Microsoft Windows CE operating system. All models have a built-in 10 channel 16 bit A/D, 8 channel digital, 3 RS232 ports, 1 RS232/RS485 port, SDI-12 port and an I<sup>2</sup>C port. For data retrieval, simply connect a PC, modem, satellite transmitter and/or cell phone. In addition, every unit comes with a minimum of thirty-two megabytes of flash disk for data and program storage and thirty-two megabytes of RAM for program execution. All units support expanding storage up to 2GB via the SD card slot. Power should be supplied from an external battery of 10-16 VDC.

All the functionality can be accessed through a PC or Pocket PC. All the operations necessary to operate the unit can be done via the graphical interface on the PC/PocketPC. In addition, the built-in LCD allows for viewing data and simple calibration and adjustment.

*9210 Xlite with Integrated Display and I/O modules*

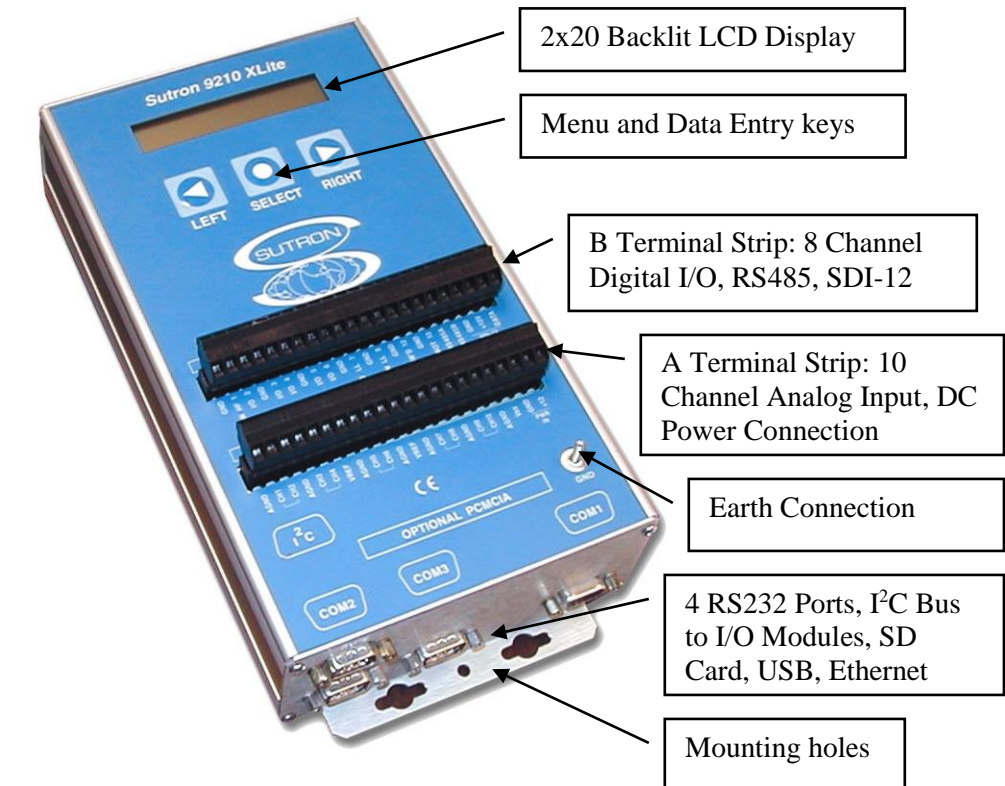

*9210B Front Endplate*

## Models

Several different models are available. The models include:

9210-0000-2B 9210  
9210-SL2-2B 9210 with Satlink2  
9210-ENC-B 9210 within rugged enclosure  
9210-SL2-ENC-B 9210 with SatLink2 within enclosure

In addition, the following are available as add-ons to the system.

### Telemetry Modules

8080-0005-1 Speech modem  
SL2-G312-1 Satellite Transmitter

### I/O Modules

8080-0002-1 Digital I/O, 8 Channels  
8080-0002-4 Digital I/O, 8 Channels with Surge Protection and 24" Cable  
8080-0003-1 Precision Analog I/O, 6 Channels  
8080-0003-3 Precision Analog I/O, 6 Channels with Surge Protection and 24" Cable  
8080-0007-1 Xpert, 10 channel, 16 bit Analog I/O

### Termination Board

6461-1239-1T RS232 Surge Protection  
6461-1240-1T Phone Surge Protection  
6461-1241-1T SDI Surge Protection  
6461-1242-1T Power Protection





# **Chapter 2: Getting Started**

## UNPACKING

---

Carefully unpack the 9210 and other components that came with the system. Note that some items come standard while other items are optional.

### Standard Items

The following items are included with every unit:

- One 9210.
- One CDROM containing PC Utilities and manuals
- One DB9 M-F serial cable.

### Common Optional Items

The next items – sold separately, either because they can be shared between systems or because not all installations require them – are often also included:

- A DB9 M-F serial cable for I/O Modules.
- Optional I/O modules
- Optional termination boards.
- System enclosure box.
- Lead acid battery.
- Solar panel regulator.

### Other Optional Items

One or more of the following might also be included:

- Analog, digital or SDI-12 sensors.
- Modem, Line-of-Site Radio or Satellite transmitter.
- Antenna.

# INITIAL CHECKOUT

---

## Powering Up

Connect power (10-16Vdc) to the PWR IN, GND and +12 connections. These connections are also labeled A21 and A22. When power is applied, the 9210 will perform some important initializations for about a minute and then flash a brief message on the LCD.

## Verify Xlite Display Works

To verify the display works, press any key and release it. The system will turn on the display and then display the station name, date/time, recording status, data and menus. If no other keys are pressed, the system will turn off the display after a few minutes.

## Adjust the Contrast (optional)

To adjust the contrast, press the SELECT button and then use the RIGHT or LEFT buttons (while holding SELECT) to adjust the contrast up (RIGHT) or down (LEFT).

## Verify XTerm Works

XTerm is a PC program used to setup and test a 9210. See Chapter 6 for the details on how to install and run XTerm.

## Verify I/O Modules Work

The 9210 comes with three built-in I/O modules: a display, an analog and a digital module. If separate I/O modules are purchased, connect the I/O modules together, and then use a 9-pin cable to connect them to the I<sup>2</sup>C port.

To verify all I/O modules are working, select the tab labeled *Setup*. If it is not visible as one of the tabs, use the scroll buttons to the right of the tabs to bring it into view. Now press the + in front of the I/O Module branch. A list of the installed modules connected to the system is displayed. If the + in front of I/O Modules is not there, the system was not able to detect any I/O modules. If external I/O modules are connected, check the cable. If not, make sure that nothing is plugged into the I<sup>2</sup>C connection. Refer to the troubleshooting section for help to get the system to find the I/O modules.

NOTE: If using external IO modules, the Xlite modules MUST be configured as module number 1 as the system will take certain readings from these modules about the system. All external modules should be renumbered starting at 2 from the IO module list in the Setup tab. See [Naming I/O Modules](#) for details on renumbering. XLite IO modules are the LCD, Analog IO and Digital IO and can be identified by a serial number of Lxxxxx, Axxxxx or Dxxxxx where the xxxx is the IO board serial number

The initial checkout of the 9210 is complete.

## Optional SLL Library

Sutron has written several custom sll's for various customers. These sll's are provided in all upgrades for convenience. While most of these sll's are specific to certain sensors, special processing, etc., other customers may find a use for them. Listed below are all the extra-SLLs that are provided in a standard upgrade zip file, along with a short description of their purpose. If you find that one of these sll's may be of some use to your application, and you want more information, please contact Customer Service.

NOTE: In some of these sll's, a serial interface is needed. In most cases, the blocks that are created, or setup tab entries that are made, will need to have full control of the com port. This is accomplished by leaving the com port set to "NONE" in the Coms (SSP/CL) branch under the setup tab. Refer to the specific documentation for the sll to see if the com port is to be defined in coms or not.

|                 |  |
|-----------------|--|
| Aanderaa.sll    | The purpose of this SLL is to receive data from an Aanderaa logger, but may also be used to parse any space or comma separated numeric data using an RS-232 com port.  |
| AirGap.sll      | The purpose of this SLL is to allow users to connect a MIROS Air Gap water level sensor to one of the COM ports.   |
| AlohaHazmat.sll | Formats and outputs messages specific to the Aloha Hazmat PC desktop software via com port. Supports Aloha weather station.  |
| ASWell.sll      | This SLL implements a custom processing block to support Alamosa Salvage Well control.   |
| ATDisplay.sll   | The purpose of this SLL is to allow users to display information from and Xpert/Xlite LOG file on an Adaptive Technologies display device. Adaptive Technologies offers a variety of indoor and outdoor displays that can be used to make information in a 9210 easily accessible to the public. |
| AtoN.sll        | Adds ability to select sensor values for inclusion into an AIS Message 8 broadcast over an AtoN (Aid to Navigation) radio, e.g., the Mando 3 by Alltek.  |
| AWOS.sll        | This SLL implements custom processing blocks and reporting mechanisms to support AWOS weather stations.  |
| CoOp.sll        | This SLL implements custom sensor and processing blocks to support CO-OP weather stations. Sensors include OTT Rain gauge and Stevens Soil moisture probe. Processing block for the Geonor Rain gauge is also included.  |
| DGH.sll         | The purpose of this SLL is to connect any DGH output module, typically a 4-20mA or 0-5V, to a com port. The DGH module simply needs to respond to the following output string:<br><br>\$1AO+0yyyy.yy<br><br>Followed by a CR. Refer to App note 33 for details on use of this                    |

|                       |   |
|-----------------------|---|
|                       | block.  |
| Evapotran.sll         | The purpose of this SLL is to add an Output block to weather stations that will calculate daily potential evapotranspiration (ET0)  |
| GPRS.sll              | This SLL adds support for GPRS cell modem communications, both transmissions and incoming message processing.   |
| GPRS232.sll           | This SLL provides a general purpose RS-232 communications block, intended to enable measurement of a variety of RS-232 sensors.   |
| IECModbus.sll         | This SLL extends the capabilities of the modbus sll to work with a device built by Applied Systems Engineering to interface to an IEC-104 network.  |
| IMD.sll               | This SLL implements custom reporting functionality required by IMD.   |
| Iridium.sll           | This SLL adds support for Iridium cell modem communications, both transmissions and incoming message processing.  |
| LCRAPLCDriver.sll     | The purpose of this SLL is to connect a serial input PLC to one of the COM ports. The PLC is used to provide remote output of the headwater and tailwater levels in reservoirs  |
| LCRASerialDisplay.sll | The purpose of this SLL is to connect a two-line Adaptive Alpha™ display to one of the COM ports. The purpose of the display is to provide remote output of the headwater and tailwater levels in reservoirs.                                       |
| ManualEntry.sll       | This SLL adds a block that allows the user to enter observed data measurements manually.  |
| Modbus.sll            | The purpose of this SLL is to add the ability to communicate via modbus to the Xpert/9210. For more information, see the document “Xpert Modbus SLL User Manual”, available separately.   |
| NIFC.sll              | The purpose of this SLL is to provide the necessary blocks to connect sensors used in Fire Weather applications.  |
| NOS.sll               | This SLL implements a reporting mechanism for NOS stations using the user login and a data file to determine the report contents. In addition, this sll adds average and measure blocks that allow data time-stamps to be centered on the interval. |
| Pflow.sll             | This SLL implements custom pump flow rate and duration calculations.  |
| PPP.sll               | This SLL adds support for PPP and SLIP protocols, as well as support for SSP messaging over related devices.  |

|                    |  |
|--------------------|--|
| PPSaver.sll        | This SLL implements custom power-saving measurement and communication algorithms for Poland Power project.   |
| QFE.sll            | This SLL adds a sensor block used to calculate standard atmosphere based on elevation.   |
| QuadW.sll          | This SLL adds the QuadW sensor block, used to measure a quadrature sensor connected to a Weeder Tech WTDIN-M module. The WTDIN-M module is capable of tracking quadrature at much faster rates than the normal Quad block in the Xpert. A single QuadW block reads all four channels of the Weeder Tech module. The WTDIN-M will retain its measurement of position until power is removed. For more information, see the document, “Xpert QuadW SLL User Manual.doc”, available separately. |
| RDI.sll            | This SLL Implements RDI protocol.  |
| Relay.sll          | This SLL contains a block intended to control a relay. The block will set a digital output for a specified time duration, and then clear the output.   |
| RS485SDI.sll       | This SLL enables SDI over an installed RS485 com port (9210s normally support RS485 on COM4, and may also have internal hardware change for other ports). NOTE: for more information on using SDI-12 over RS485, see <a href="#">Using SDI-12 over the RS-485 Port</a>   |
| SR50.sll           | This SLL enables measurement of SR50 ultrasonic height gauge.  |
| SRP.sll            | This SLL causes the 9210 to prompt the user to download data after the insertion of a storage card (USB or SD). The prompt for “recent” data will download data from ssp.log since the last download. The prompt for “status” data will download the entire system log. Requires firmware version 2.4 or above.  |
| TerminalServer.sll | This SLL adds commands to the remote command line interface based on the user login.   |
| UWAPL.sll          | This SLL adds custom blocks and telemetry processing for specific customer system performing wave analysis. Sensors used: Nortek AquaDopp, AirMar PB200, Microstrain 3DM-GX3-35 AHRS, Y201 serial camera, WetLabs ECO Puck, and AADI Conductivity Sensor 4319. The level of custom processing is high. Please contact Sutron Customer Service for more information about using this SLL.   |
| VibratingWire.sll  | The purpose of this SLL is to allow users to connect a Canary Systems VW DSP serial interface to one of the COM ports on a Sutron Xpert or Xlite (Model 9210) data logger. The VW DSP can be used by itself to measure temperature and pressure from two vibrating wire sensors (e.g. those made by Geokon). The VW  |

|              |   |
|--------------|---|
|              | DSP can also be wired to one or more Canary Systems MiniMuxes, providing the capability to measure from additional sensors in increments of 16 or 32 per MiniMux. |
| VWireMux.sll | The purpose of this SLL is to allow user to log multiple pressure transducer and optional thermistor readings by using a Canary Systems MiniMux™ digital switch.  |

## PREPARING FOR SET-UP

---

This section discusses various issues important to know before setting up the 9210.

### Analyze the System

Chapters 3 and 4 describe all the elements that go into setting up the 9210. Before jumping in to setting up the unit, it's useful to think about the nature of the problem the 9210 is being used to solve. The following questions can help guide that thinking:

What data needs to be collected?

What sensors will give this data?

What is the raw output of these sensors, DC voltage, AC voltage, frequency, Serial, etc.?

Can the built-in I/O handle all of these sensors, or are additional modules needed?

How often should this data be collected?

What processing is needed to convert this raw data into a meaningful value? Is there already a block defined to do this processing or is a generic input needed?

Where does the data need to go once it is processed, to a Satlink, a modem, a LOS radio, a serial device (PC, display, printer) or just to a log?

Chapter 5 describes several example setups that can help get you started in configuring the 9210. If you need more help, don't hesitate to call our Customer Service department. They've worked with many data collection and reporting scenarios, and can help you set up your system just as you need.

### Choosing the Right Block

As Chapters 3, 4 and 5 will reveal, the 9210 setup is based on "blocks" that perform a specific function on data collected from a sensor, or from another block. The 9210's *Graphical Setup* provides an interface to connect and configure these blocks. The 9210's *EzSetup* interface also uses blocks, though they are hidden from the user's view.

Here's a simple map of sensor types to block types:

| Sensor Type         | Sensor Block                        |
|---------------------|-------------------------------------|
| DC voltage output   | VoltMeter or ADC                    |
| Resistance          | ADC                                 |
| Frequency output    | Counter or Frequency                |
| SDI-12 output       | SDI-12                              |
| RS-232/RS485 output | RS232 (GPRS232.sll) or Basic Sensor |

See Appendix A for a listing of all the different types of blocks available in the system.

The most common measurement type is an analog measurement, i.e., either a voltage or resistance. Many analog sensors simply specify a +5 V excitation voltage and provide a slope and offset. The ADC block provides all the properties needed to make this measurement.

For the most accurate analog reading, use the ADC block's *Double Volts* option, and multiply the given slope by 5. *Double Volts* will always return a ratio of REF / reading, meaning it will return a value between 0 and 1, since the slope for a +5 REF assumes an output of 0 – 5. Multiplying the given slope by 5 will return the correctly scaled value. Using *Double Volts* will



require 2 analog channels. If the system is running low on analog inputs, the *Voltage* reading could be used, if you multiply the given slope by 2 (since  $V_{ref}$  is 2.5).

What if you don't see a block that appears to do what you need? Starting with version 2.2, the 9210 supports Xpert Basic, a programming language with which you can write your own blocks, and other custom processing. Refer to the Xpert Basic Users Manual for more details.

## How to Select a Completion Resistor

Measurements that require a completion resistor use the resistor as a reference for the reading. The accuracy needed (percent accuracy, Temperature Coefficient (TC)) will depend on the accuracy needed for the specific sensor being measured.

Generally, an accuracy of 4 times of the sensors accuracy should be used. I.E If the sensor were only accurate to  $\pm 4\%$ , a 1% completion resistor is sufficient. For a 0.1% accurate sensor, at least a 0.025 % accurate resistor is needed. HOWEVER, since the cost of these resistors increase drastically as the accuracy increases, only the accuracy needed should be used. So, even if the sensor is accurate to  $\pm 0.1\%$ , if the only requirement were to be accurate to  $\pm 4.0\%$ , use a 1% completion resistor.

Sutron sells three completion resistors, all with 5ppm TC or better and an initial accuracy of 0.01%, as follows:

| Part Number | Resistance |
|-------------|------------|
| 1113-1244   | 100 OHM    |
| 1113-1242   | 1 Kohm     |
| 1113-1243   | 10 Kohm    |

The TC should be selected for the temperature range needed, generally a 25ppm or 5ppm TC will suffice.

To improve the accuracy of the reading or if using a resistor other than specified (like using a 100 ohm in place of a 20 ohm), the completion resistor can be calibrated and a slope computed by following this procedure. The ohmmeter should have an accuracy that is at least 4 times needed (as stated above):

1. Using an accurate ohmmeter, measure the resistor and note the actual reading.
2. Calculate a correction factor by dividing the expected reading by the actual reading, e.g.,  
Expected 20, using a 100 reading exactly  $100 \Rightarrow 20 / 100 = 0.2000$   
Expected 20, using a 20 reading 20.52  $\Rightarrow 20 / 20.52 = 0.9747$
3. To get from the RAW electrical reading back to a physical unit, multiply the given (or calculated) slope times the correction factor to get a new, Corrected Slope. For example, using a 4-20mA output sensor with a -40 to +60 degrees C range, the calculated slope is 6.25 and an offset of -65, so for the resistors above:

$$\text{(Calculated slope) } 6.25 \times \text{(Correction factor) } 0.20000 = 1.250$$

$$\text{(Calculated slope) } 6.25 \times \text{(Correction factor) } .9747 = 6.0919$$

NOTE: the offset will stay the same at -65 for both resistors

## Using SDI-12 over the RS-485 Port

The 9210 has the ability to use RS-485 for SDI-12 sensors that support SDI-12 over RS-485 interfaces. Differential SDI-12 is not a defined standard. It is a low power modification of an RS-485 interface. It overcomes the cable limitation of SDI-12 since transmitted data is not referenced to the power supply ground. It does not utilize a power consuming DC termination resistor. The data signaling rate and protocol conform to SDI-12 standards. The specification can be obtained at <http://www.sdi-12.org/>

Four wires are needed to use the differential SDI-12 interface, two for power and two for data. Wire as follows:

|           |   |
|-----------|---|
| SENSOR    | 9210  |
| GND       | SDI-12 GND  |
| +12V in   | SDI-12 +12 (or PROT 12)                                 |
| RS-485(B) | RS485A (idles high)                                     |
| RS-485(A) | RS485B (idles low)<br>Same polarity as SDI-12 data line |

**NOTE:** Since this is not a defined standard, the labeling of the data lines is also not standardized. The A and B in the sensor column above reflect the naming utilized in the RS485 specification. The labeling on the 9210 is opposite of the RS-485 standard. No harm will be caused by reversing the data lines, but there will be no communication.

When no SDI-12 communication is occurring, no device is driving the data lines, but once the port has been opened for the initial communication, the 9210 applies a slight bias current to maintain the idle condition. If the sensor is expecting a stronger idle bias, then that could be provided with external resistors. Stronger biasing can be achieved by placing a 100K resistor from the 9210's RS485B terminal to GND and another 100K resistor from the 9210's RS485A terminal to PROT 12.

There are two ways to use SDI-12 communications over RS-485:

- 1) the standard SDI port can be redirected to an RS485 port (typically COM4, the default is COM5), or
- 2) by using the RS485SDI sll (supports RS485 on COM4, only)

**NOTE:** In either case, the com port settings in the Coms (SSP/CL) section of setup should be left as none. The Coms (SSP/CL) entry is strictly for configuring SSP and Command Line communication devices.

### Redirecting SDI to COM4

Use this option when you do not want to use the RS485SDI sll and you do not need SDI over BOTH the standard SDI port (COM5) and an RS485 port (COM4 supports RS485; you may also have purchased an RS485 option on another COM port). To redirect SDI to COM4, the XPERT.EXE program must be run with the /SDI COM4: command line parameter. To do this, edit the autoexec.bat to look like this:

```
\flash disk\remote.exe com1:115200  
\flash disk\xpert.exe /SDI COM4:
```

Once the autoexec.bat has been modified, reboot the system. Now, when SDI-12 sensors are configured in the setup, the system will communicate out the RS-485 port on the "B" terminal strip labeled RS485 A / RS485 B (OPT COM4).

NOTE: Once the 9210 has been configured this way, ALL SDI-12 sensors will use the RS-485 port for communicating. The RS485SDI.sll cannot be used in this configuration, when SDI has been redirected to COM4:.

### **Using the RS485SDI SLL**

Use this option when you don't want to redirect the default SDI port (for example, if you want to use both RS485 SDI sensors and standard SDI sensors, at the same time). To use the RS485SDI sll, use XTerm to download RS485SDI.sll from the "Extra SLLs" directory on the installation disk and reboot the unit. Then add one or more RS485SDI setup blocks to the setup and configure them with the appropriate addresses and commands.

The RS485SDI SLL only supports SDI on RS485 COM4.



# **Chapter 3: Operating the 9210**

# LOGGING IN

---

## User Access

After connecting with Xterm, two choices of access are available – Retrieval and Setup. Each succeeding level provides all the privileges of the preceding level. Therefore, users logging in under Setup Access can retrieve data, but users logging in under Retrieval Access cannot access the system setup. Multiple usernames/passwords (accounts) are allowed for these levels. If no users are added for a particular level, then that level can be entered without a password.

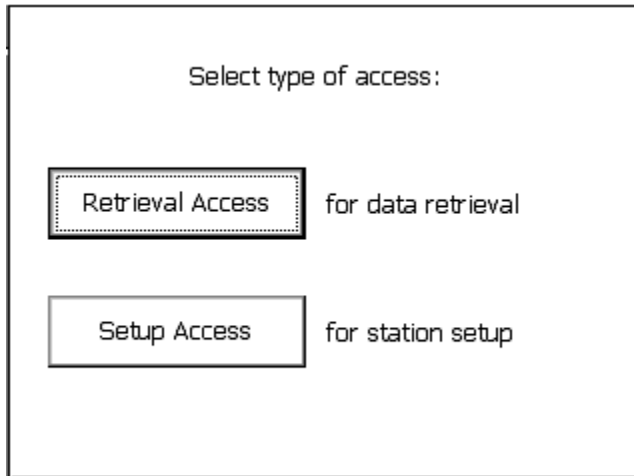

Logging into the unit causes a note to be sent to the system log, recording the username and time of the login. The user accounts are maintained on the *Setup* tab under *Users*. Access to this tab is available to the Setup group only.

Press the Logout button on the Main tab to logout. NOTE: Logout does not close Xterm, it just logs out of the system.

## Tab Overview

To see all available tabs, login using the Setup Access button. Many tabs are available, clicking one of these tabs will bring it to the foreground for viewing. Of all the available tabs, the *SETUP* tab is used primarily to set the system up, the other tabs simply provide station status or details on collected data.

## MAIN TAB

---

After logging in, the display should look similar to the one shown below, with the *MAIN* tab in the foreground. The *MAIN* tab is where information about the station status is primarily displayed.

Across the top of the screen is a text label that identifies the platform. Under this label are a series of tabs like the tabs on file folders. These tabs are used to provide quick access to the different functions.

The screen image below reveals tabs for *Main*, *Setup*, *Sensors*, *Data*, *Log* and *Status*. The actual tabs displayed on a system depend on the DLLs installed in the system and the access mode selected at login.

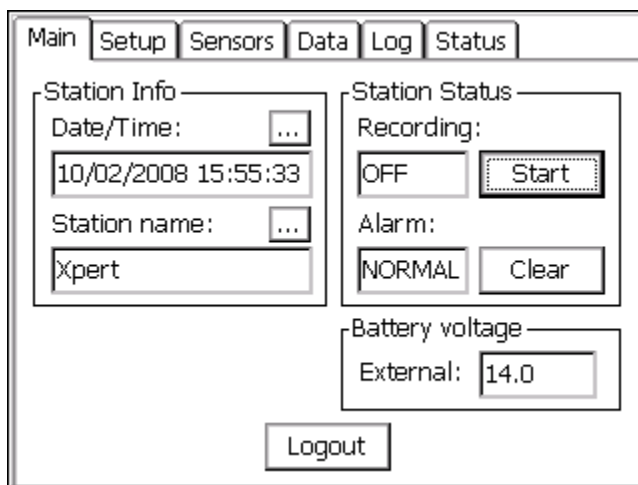

### Date/Time

Date and/or time are used to perform scheduled functions. The internal clock will keep time accurate to ten seconds a month over the temperature range of -40 to +60 C. The date and time is maintained even after power is removed from the system by a lithium coin-cell battery. NOTE: On Satlink systems, with self-timed transmissions enabled, the system will synchronize its clock to the Satlink periodically, maintaining higher clock accuracy.

To change the date or time, press the **[...]** button to bring up the Set Date/Time window shown below. Use the stylus or the << or >> buttons to move from one field to the next, and use the numbers in the virtual keypad to enter the new value. The values in the field can also be incremented or decremented via the + and - buttons.

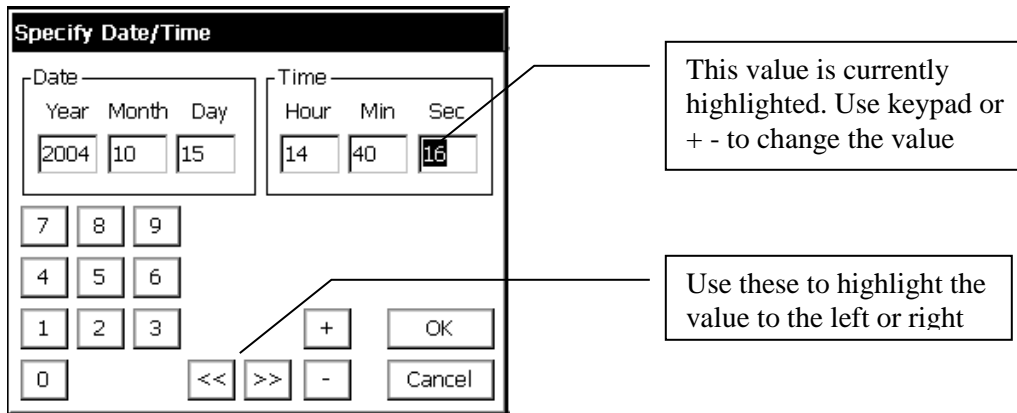

## Station Name

The station name is the general-purpose identifier for the station. It can be up to 16 alphanumeric characters. This name does not need to be the same as the GOES/METEOSAT identifier, but is used when connecting into a SSP system as the slave station name. When communicating to another station, or base station (PCBASE, XCONNECT), this name is case-sensitive, therefore this name should always be entered in UPPERCASE letters to avoid confusion.

NOTE: If the station name is changed, power must be cycled for SSP communications to use the new name. When the 9210 is started, it will try to load a setup file with the same name as the station name.

## Station Status

The Station Status box indicates both the recording and alarms states, and contains buttons to affect those states.

The recording status box indicates the current state of recording (i.e., whether measurements are being made and logged). This box also indicates whether transmissions are enabled when recording is on. When recording is off, the status box reads “OFF” and the button to its right is labeled *Start*. Pushing *Start* will start recording, changing the status box to read “ON” (or “ON+TX”, if transmissions have been enabled in the setup). The *Start* button then changes to read *Stop*.

The alarm status box indicates the current alarm state. The current alarm state may be NORMAL, ALARM, or ALERT. The Clear button is used to clear the current state (a clear during ALERT transmissions the system to ALARM, while a clear during ALARM transmissions the system to NORMAL). See *Coms (SSP/CL)* under *Setup* for more information.

## Battery Voltage

The Battery Voltage status area displays the supply voltage. This value is measured and updated every 5 minutes. This is read from the built-in Xlite Analog module at module number 1. If external analog modules are connected to the system, their module number MUST be set to 2 or higher.

The internal lithium clock battery should be replaced every 5 years. This battery is only used for preserving date and time when power is removed from the system. If on power up, the system



detects that it has lost the date and time, it will set the date to 1/1/1984. No other operating parameters are preserved by this battery. See Common Maintenance and troubleshooting for information on changing the battery.

## **Logout**

Pressing *Logout* will logout of the system and re-display the login screen. NOTE: If using Xterm over a modem, or other communications device, the connection to the unit is not shut down on a logout. Close XTerm by pressing the X in the upper right hand corner to ensure the remote system can go into its lowest power mode.

## SETUP TAB

The setup tab allows for viewing and editing system settings. The items shown in the setup tab will vary depending on the configuration of the system and the version of the system software. Some standard entries are: *Graphical Setup*, *I/O Modules*, *Log Files*, *Self-test* and *Setup File*. Examples of entries that might also appear include: *Coms (SSP/CL)*, *EZSetup Measurements* and *Satlink*.

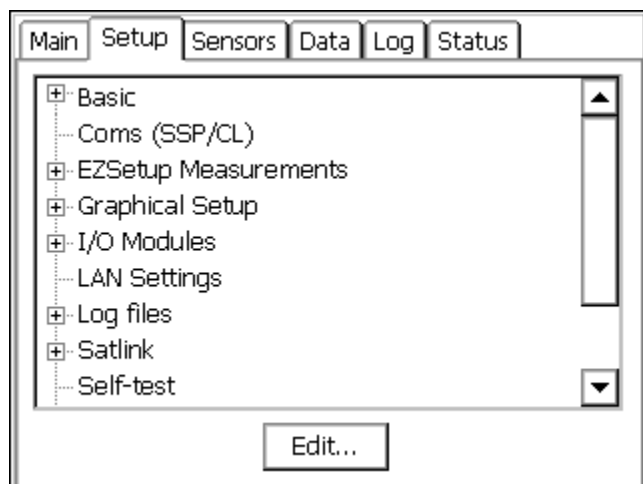

### Tree Overview

Items in the setup tab are displayed with branches that can be expanded or compressed by clicking the '+' or '-' next to the branch. This structure allows for displaying only as much information on the screen at one time as desired.

The following table gives a brief description of the purpose of each item. The sections following the table give more detail on each item.

| Tree Item            | Description  |
|----------------------|--|
| Basic                | Used to compile and schedule basic programs. See the Xpert Basic SLL User's Manual for more information.   |
| Coms (SSP/CL)        | Used to configure SSP and Command Line communications (e.g., communications with Xconnect, PCBase, Xterm, Hyperterminal, etc.). This section is not used with most extra sll's that use com ports, unless the documentation for that sll says to use a specific connection in the Coms setup.<br><br>Note: See Chapter 7 for coms pinouts and jumper settings. |
| EZSetup Measurements | Used to define simple (single input) measurements. Sensor measurements defined here can be measured or averaged on a regular interval, have a slope and offset applied, be displayed on the front panel, be transmitted via Satlink or modem, and be used to identify alarm conditions.  |

|                 |  |
|-----------------|--|
| Graphical Setup | Used to define both simple and complex measurements. Measurements can have one or more inputs cascading into one or more outputs. Special processing blocks can be used to implement complex calculations, including polynomial, interpolation table, f(x,y), and others. See the Processing section in Appendix A, for descriptions of all possible blocks. |
| I/O Modules     | Used to view address and serial numbers of I/O modules connected to the system. The 9210 has three modules built into it, AIO1, DIO1 and DSP1. Note: If you connect any external I/O modules to the system, their module number MUST be set to 2 or higher. See <a href="#">Naming I/O Modules</a> .   |
| LAN Settings    | Used to view and configure LAN settings, e.g., configuring power to the LAN (ethernet) to turn on when the 9210 powers on, or automatically when a device is connected.  |
| Log Files       | Used to view, and define new, log files.   |
| Satlink         | Used to configure a Sutron Satlink transmitter.  |
| Self Test       | Used primarily by the factory for verifying the unit meets specifications. Please note that external test harnesses and cables are required for all tests to pass.   |
| Setup File      | Used to manage setups. On power up, the setup file having the same base name as the station name is loaded, or if such a file doesn't exist, the file "default.ssf" is loaded, if it exists.   |
| Users           | Used to define system users in terms of name, password, access level, and inactivity timeout.  |

## Coms (SSP/CL)

Coms SSP/CL (functions included in coms.sll) enhances the remote communications abilities by adding support for the Sutron Speech/Voice modem, alarm detection and transmission with Speech, or via a Hayes compatible data modem, a LOS Radio modem, or a direct connection. Note: GPRS, Iridium, and Satlink communications are not managed in this entry. See their respective entries on the Setup tab.

SSP/CL com ports are configured for Remote in the autoexec.bat file; factory default is a direct connect on COM 1 with no alarms going out the port. To add support for alarms and/or speech to other COM ports, simply define them in the Coms (SSP/CL) entry in the *Setup* tab. The system will then reconfigure remote to start running the new configuration immediately and update the autoexec.bat for the next power cycle.

The **Coms Tag** block in the graphical setup is used to name SSP "cur data" points in the system and to specify speech phrases for Voice Modem, if defined. The **Alarm** block in the graphical setup is used to define what levels are considered "in-alarm", which may trigger alerts (transmissions) over SSP/CL comms devices.

Alarm: A condition when one or more sensors exceed their alarm limits.

Alert: A condition which when triggered will cause the system to transmit immediate messages.

An Alert can be configured to occur when a sensor goes in to alarm, out of alarm, or both. When an Alert occurs the “Alarm Status:” on the Main menu turns to ALERT!. The system will then attempt to send an alarm message to the various configured devices. By default the software will try a Direct Connect first, then a LOS Radio, a Speech/Voice modem, and then finally a Data Modem. If at any time the ALERT is acknowledged, the system status will change to ALARM or NORMAL and the transmissions will stop. OFF will be displayed if alarm transmissions have been disabled by for instance a voice modem user or a Basic program.

The Direct Connect, LOS Radio, SSP and RS485 blocks are also capable of sending alarm messages on a regular interval. There can be one interval for when the system is in ALARM and another for when everything is NORMAL.

The [Clear] button (on *MAIN TAB*) is used to acknowledge an ALERT condition manually, causing any alert transmissions to cease. If the system is still in ALARM that condition may be cleared as well by pressing the [Clear] button again, and the system should return to NORMAL until the next measurement occurs and any alarms are redetected. If ALERT transmissions have been disabled (OFF), then pressing the [Clear] button will re-enable them.

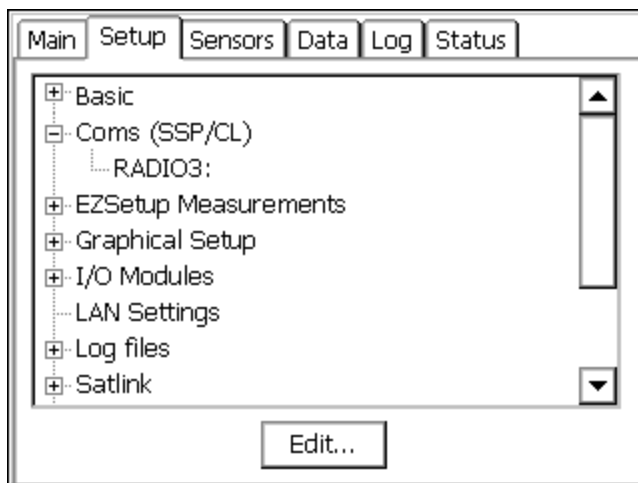

### COMS (SSP/CL) Setup Menu

The Setup tab is used to assign the various devices to a port. This is done by clicking *Coms (SSP/CL)* and pressing [Edit...]. This brings up the Com Port Setup Menu as follows:

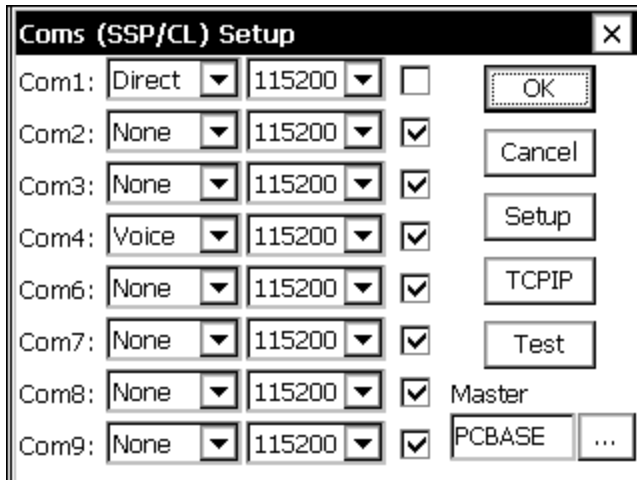

The ports and baud rate to use are configured from this menu. Each port can be configured as None, Direct, Radio, Modem, Voice, SSP or RS-485.

Checking the checkbox next to each port will tell the Xlite to enhance and manage the port above and beyond what Remote alone does. This includes sending out alarms on the port, as well as handling speech dial-in, and dial-out, and support for SSP blocks which can be used to send and retrieve tags, or set the time. Typically, com1 would not be checked, as it is used for Xterm communications to setup the station. You would check it if you wanted to connect a communications device to com1 and see alarm data go out that port.

The Master ID, which is the name of the PC Base Station in an SSP system, is specified here too. Other SSP parameters can be specified in the Setup menu, and pressing the Test button will test communications.

### SSP Settings

Pressing Setup button displays the following SSP Settings menu. This dialog allows you to configure additional settings for SSP communications, over a variety of devices. All entries, except # retries, are in **units of seconds**.

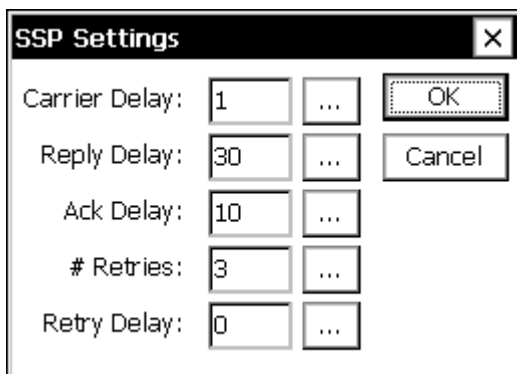

Carrier Delay: When the com port is set for "RADIO" communications, this is how long to key the transmitter (assert DTR) to warm up the radio before sending data. With Sutron radios typically 1 second or less is needed, but this may need to be increased if hardware repeaters are used in the network, as each hard-repeater in the network needs time to warm-up.

**Ack Delay:** When the Xlite is acting as a master, this is how long to wait for a response to a request (aka an acknowledgement). The default value is 10 seconds, which is suitable for a single hop 1200 baud system. It may be reduced if higher-baud rates are available, or increased if store and forward repeater hops are necessary.

**# Retries:** More precisely, this is the total number of tries. When an SSP request is made that requires a reply (such as a GetTag) the system will wait for the Ack Delay for the reply. If a reply is not received then one or more retries is performed. # Retries is the total number of attempts to make. The default value is 3. Combined with the default Ack Delay of 10 seconds, this means SSP will send the same message as many as 3 times, with a 10 second delay between each attempt before it will timeout and report a "tx error". All retry messages have the same FLAG SEQUENCE number as the original message. This is used to prevent the same message from being processed twice due to a long network delay.

**Reply Delay:** When the Xlite is acting as a slave, this is how long the RTU will wait for a message before timing out. This delay includes the time needed for all retries to occur, so it's typically set to the value of AckDelay \* (# Retries). The only situation where the Xlite acts as a slave currently is when it's receiving a new setup from a base station. The Basic GetMessage() function may be used to add slave operations to the Xlite, but the timeout value is specified as a parameter to the function.

**Retry Delay:** This parameter is rarely used in the software and inserts an extra delay before attempting a retry, and is hence redundant with the AckDelay. Recommendation is to just leave it set to 0.

### TCPIP Alarm Setup

Pressing the TCPIP button displays the TCPIP Alarm Setup menu (requires V3.2 of the Xlite application or later). This menu allows alert and/or alarm messages to be configured to be sent to a base station over the LAN connection. The messages may be in SSP format or text format. Each URL is attempted in order (1 then 2, then 3) until the message has been successfully delivered (unless Send to All is enabled). As long as alerts are not disabled, when an alert occurs, TCPIP delivery will be attempted first before other communication methods.

| URL          | Type    |
|--------------|---------|
| 1: XCONNECT2 | SSP     |
| 2: 127.0.0.1 | Compute |
| 3: myorg.gov | Data    |

Tx Normal Rate: 01:00:00

Tx Alarm Rate: 00:10:00

(00:00:00 will disable a Tx)

Send to All

Disable Alerts

OK Cancel

URL: Machine name or IP address to send a message to. Leaving an entry blank will cause it to be skipped.

Type: Type of message to send. SSP selects an SSP message. The Xlite waits for an OpAck packet to be received to confirm reception. Computer selects a text message with a prompt to press ENTER to confirm reception. Data also selects a text message but it doesn't wait for confirmation and assumes it has been delivered correctly if the TCPIP stack does not report an error making the connection and sending the message.

Tx Normal Rate: Selects an interval at which a message will be sent when the system is in the NORMAL state (entering 00:00:00 will disable this feature).

Tx Alarm Rate: Selects an interval at which a message will be sent when the system is in the ALARM state (entering 00:00:00 will disable this feature).

Send to All: If checked messages will be sent to all 3 URLs. If left unchecked then each URL is tried in order until a message has been delivered.

Disable Alerts: If checked this will disable alert messages to be sent via TCPIP, but not Tx Normal or Tx Alarm messages. Alert messages occur when a sensor transitions in to (or out of) the alarm state.

Options: The options button brings up further options that may be enabled for each URL.

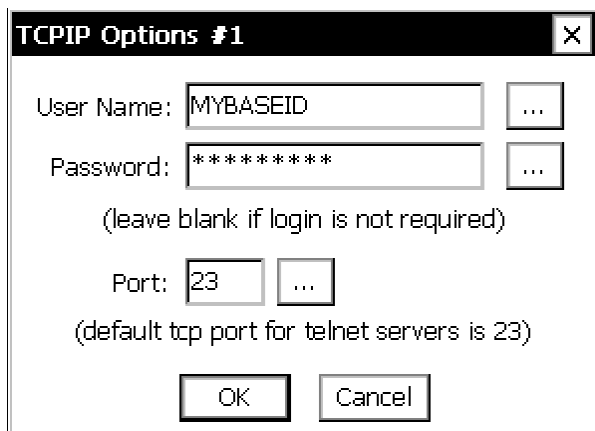

The image shows a dialog box titled "TCPIP Options #1". It has a close button (X) in the top right corner. The dialog contains the following fields and text:

- User Name: MYBASEID [...]
- Password: \*\*\*\*\* [...]
- (leave blank if login is not required)
- Port: 23 [...]
- (default tcp port for telnet servers is 23)
- OK [Cancel]

User Name: SSP alarms may require a user name in order to login to the server before the alarm message can be sent. The user name can be specified with this field, leave it blank if login is not required.

Password: SSP alarms may require a password in order to login to the server before the alarm message can be sent. The password can be specified with this field, leave it blank if a password is not required.

Port: The messages are sent using TCP socket communications with auto-detection of the Telnet protocol. The standard port for a telnet server (including the Xlite's) is 23, but on a base station that port may not be available (or desirable) and hence a different port number may be selected with this field.

## Communication Test Menu

Pressing the Test button displays the following Test Menu. This menu gives communications statistics for the selected COM port along with a way to run some simple tests on the port.

Key and UnKey force DTR on and off for the port.

Send Mail and Check Mail can be used to communicate with other 9210s or a master station. Mail messages are simple text messages. Pressing Send Mail will cause the system to prompt for a destination and a message. The destination can be a master station or another field station. For mail to work, the unit must have a dedicated or LOS radio communications link. Send and Check mail use Sutron Standard Protocol (SSP) for the mail messages.

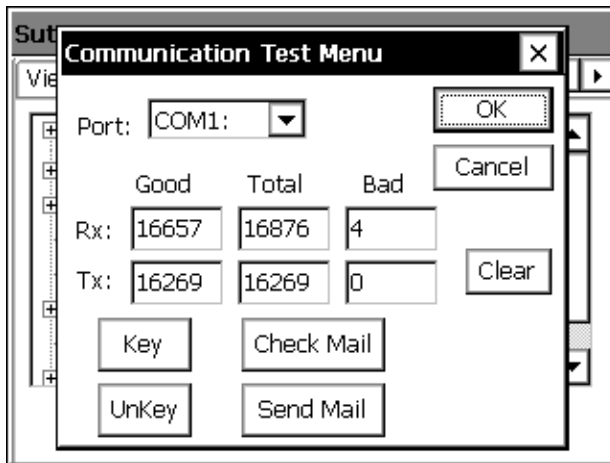

## Coms (SSP/CL) Configuration Settings

After you define a device under Coms (SSP/CL), it is displayed as a sub-item of the Coms (SSP/CL) entry. See the picture below, where the comms devices "RADIO2:" and "MODEM3:" have been defined.

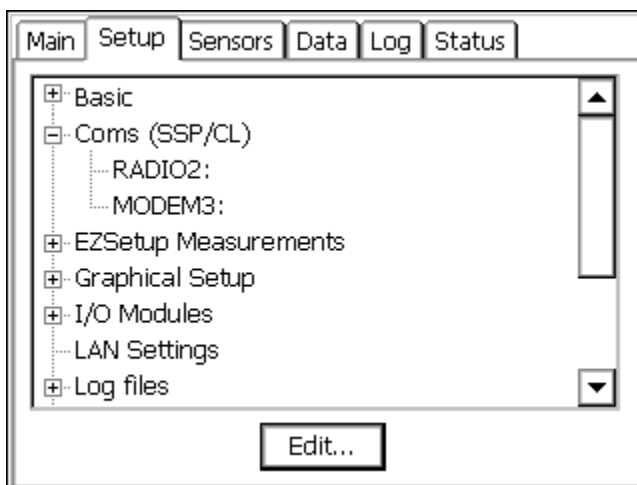



To access the configuration settings for one of these devices, simply highlight the device in the tree, and press the “Edit” button. This will bring up the config settings that are specific to the device selected, which are described in the following sections.

### Direct Connect Settings

This dialog is used to configure the alarm and alert settings for the direct connection.

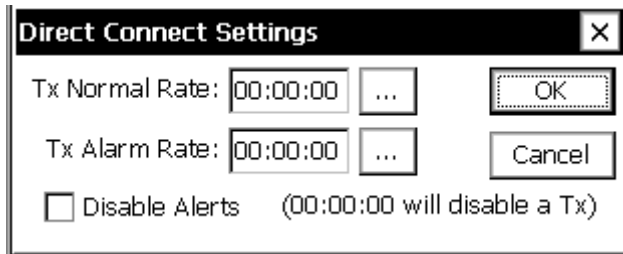

*Tx Normal Rate* is the rate at which alarms are transmitted when no sensors are in alarm, and *Tx Alarm Rate* is the rate used when a sensor is in alarm. They can be set to 00:00:00 to inhibit timed alarm transmissions. *Disable Alerts* may be checked to prevent messages to be sent out the port when the system enters the alert state.

Direct connections support two types of alarm messages. If SSP is detected, an SSP alarm is sent, otherwise a simple text message is sent, and a prompt is made asking for the alarm to be acknowledged.

### Voice Modem Settings

This is the Voice Modem settings screen.

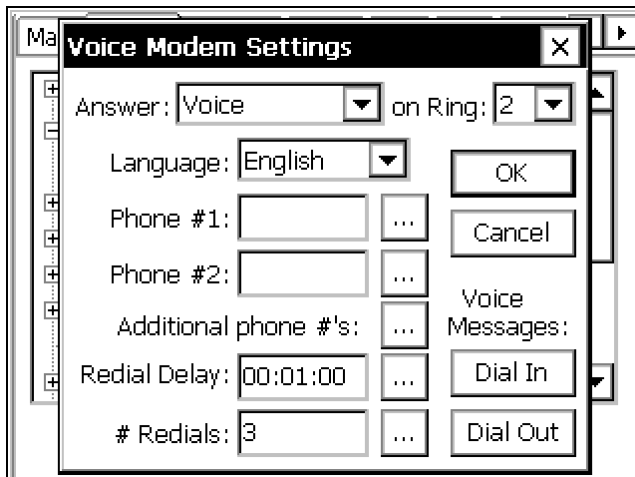

When an alert occurs each phone number is tried in sequence starting with Phone #1, until an acknowledgement occurs. Or until the # Redials has been attempted on each number. The Answer mode can be configured to answer in Voice, Data, or Voice & Data. The Voice & Data mode prompts when it answers the phone to “Please press pound”. If the person dialing in presses the “#” key on the telephone a voice message is spoken, otherwise a data carrier is transmitted and a data connection is attempted. The Dial-in and Dial-out buttons allow the Dial-

in and Dial-out messages to be configured. Speech phrases are stored in the \Flash Disk\speech\English directory or \Flash Disk\speech\[*language*] directory depending on which language is selected.

By default the voice modem will speak the specified Dial Out message. If the modem is unable to detect “ring-back” it may start speaking a phrase before someone answers the phone. Because of this, the message spoken should either be repeated or wait for a button to be pushed before speaking the alarm data. If a Dial Out message is not defined or the letter “D” is placed at the beginning of a phone-number then a data alarm will be sent. The data message will try to automatically detect a PC Base Station and send an SSP message, otherwise a simple text message is sent and a prompt is made asking for the alarm to be acknowledged.

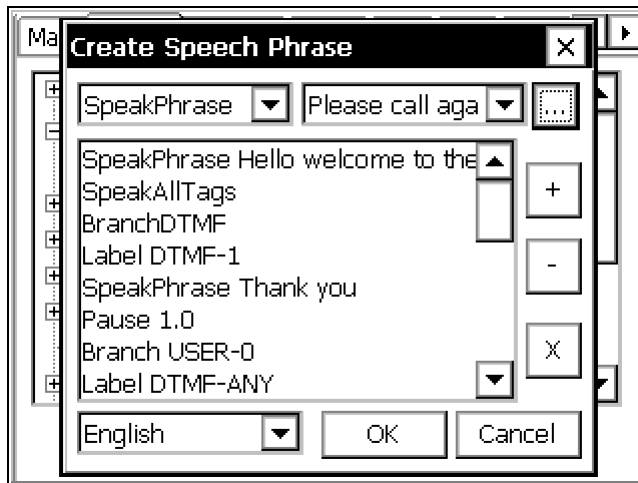

Above is an example of the speech phrase editor screen. The combo box in the top left is used to select a speech command (such as “SpeakPhrase”). The combo box in the top middle is used to select any optional parameters (such as the phrase to speak in this example). The [...] button is used to edit and/or add the command to the command list. [+] is used to move a phrase up in the list, and [-] is used to move a phrase down. [x] can be used to delete a phrase from the list. The combo box on the bottom of the screen can be used to select the language for the phrases displayed, this is used in conjunction with the “Language” command to setup a bilingual speech phrase.

### Speech Dial-in and Dial-Out commands

| Command    | Description   |
|------------|---|
| AckAlarms  | Acknowledge alarms in the system. Further alert transmissions will cease until a new alert occurs or it’s time for an alarm transmission.           |
| AnswerData | Switches to answering the phone in data mode.   |
| Branch     | Branches to another part of the speech command specified by a user Label. Searching for the label begins with the first line in the speech command. |
| BranchDTMF | Wait for and branches based on a DTMF press. Searching for the label begins at the current line in the speech command. The phone will be            |

---

|               |   |
|---------------|---|
|               | hungup after 60 seconds if a button is not pushed.  |
| BranchNoDTMF  | Same as Branch, but the Branch is only performed if a DTMF button was not pressed on the phone. This is usefull for repeating a series of phrases over and over until the user pushes a button. If a button is pushed, it will be queued, and should be processed by a BranchDTMF command. Normally there is a 90 second inactivity timeout that is reduced to 60 seconds when this command is used. The phone is hungup if an inactivity timeout occurs.   |
| Call          | Calls a subroutine in another part of the speech command specified by a user Label. This works just like the Branch command, except that control may be returned to the command after the Call when a Return is encountered. Subroutines may call other subroutines.  |
| DisableAlarms | Disables further alarm transmissions using the Voice modem and other SSP devices such as LOS Radio. They may be re-enabled using the EnableAlarms command, by Basic program, or by accessing the main menu and pressing CLEAR on the "Alarm: OFF" item.   |
| EnableAlarms  | Re-enables alarm transmissions that have been disabled with DisableAlarms.  |
| Hangup        | Hang up the phone and terminates the speech command   |
| InputManual   | Input a number from the user. The number is entered with the DTMF keypad. "*" may be used to specify a decimal point. Press the "#" button is used to indicate the end. Pressing "*" twice will allow the number to be re-entered. See SpeakManual, and StoreManual.<br><br>Example:<br><br>12*345#<br><br>would enter the number 12.345. Negative numbers are not supported.   |
| Label         | Label a section of the speech command, two types of labels exist. User and DTMF. DTMF labels are branched to in response to the BranchDTMF command, and user labels are branched to using the Branch command.   |
| Language      | Switches to the specified language folder. This effects all speech phrases that may be spoken (ex: SpeakPhrase and SpeakData) after the command. When adding phrases, be sure to select the appropriate language using the combo box at the bottom of the screen. Using subroutines (see Call and Return commands) it's possible to create a single phrase that can be spoken in multiple languages. The key is to select the language with the Language command and then Call the bi/multi-lingual phrase. For this to work, the (.vox) speech files must be given the same name across the languages. |
| Return        | Returns from a subroutine by branching back after the last Call command. If the Call command wasn't used, then control passes to the  |

---

---

|               |   |
|---------------|---|
|               | beginning of the phrase.  |
| Pause         | Delay the speech command for the specified number of seconds (resolution down to milliseconds)  |
| SpeakAlarms   | Cause all sensors with an attached ComTag to have their prefix phrase, value, suffix phrase and alarm status spoken.  |
| SpeakAllTags  | Cause all sensors with an attached ComTag to have their prefix phrase, value, suffix phrase and alarm status spoken.  |
| SpeakData     | Speak just the last measured data value of the specified sensor.  |
| SpeakLiveData | Force measurement and speaks just the live data value of the specified sensor.  |
| SpeakLiveTag  | Force measurement and speaks the prefix phrase, live value, suffix phrase and alarm status of the specified sensor.   |
| SpeakManual   | Speak the last data entered by the user with the InputManual command (or 0 if no value has been entered).   |
| SpeakNum      | Speak the specified number.   |
| SpeakPhrase   | Speak the specified phrase.   |
| SpeakTag      | Speak the prefix phrase, value, suffix phrase and alarm status of the specified sensor.   |
| StoreManual   | Store the last data entered by the user with the InputManual command (or 0 if no value has been entered) in to the specified tag. This allows the user to change operating values of the system (use WaitForPass to authorize). |
| WaitForPass   | Pause until the user enters a DTMF sequence which matches the specified sequence. The system will timeout if the user doesn't enter a code in less than one minute.   |

---

Use Branch USER / BranchDTMF / LABEL to build a menu system.

Label USER-0  
 SpeakPhrase Hello welcome to the Sutron Xpert  
 Pause 1.0  
 SpeakPhrase Please press pound  
 Pause 2.0  
 BranchNoDTMF USER-0

This introduction is repeated over and over (for up to 60 sec) until the user presses the “#” button on the phone.

BranchDTMF  
 Label DMTF-#  
 Label USER-1  
 SpeakPhrase For live data  
 SpeakPhrase Please press  
 SpeakPhrase 1  
 Pause 1.0  
 SpeakPhrase To acknowledge alarms  
 SpeakPhrase Please press  
 SpeakPhrase 2  
 Pause 1.0  
 SpeakPhrase To hang up  
 SpeakPhrase Please press  
 SpeakPhrase 3  
 BranchDTMF  
 Label DTMF-1  
 SpeakAllTags  
 Pause 1.0  
 Branch USER-1  
 Label DTMF-2  
 AckAlarms  
 SpeakPhrase Alarm  
 SpeakPhrase Acknowledge  
 SpeakPhrase Thank you  
 Pause 1.0  
 Branch USER-1  
 Label DTMF-3  
 SpeakPhrase Thank you  
 SpeakPhrase Please call again  
 Hangup  
 Label DTMF-ANY  
 Branch USER-1

BRANCH DTMF will go to the DTMF number pressed.

DTMF 1 speaks tags and DTMF 2 Acknowledges alarms, speaks alarms and then returns to the top menu (with BRANCH USER-0), DTMF 3 will hang-up the phone. Label DTMF-ANY say that if any other DTMF is pressed, return to the top menu.

## LOS Radio, SSP, and RS-485 Settings

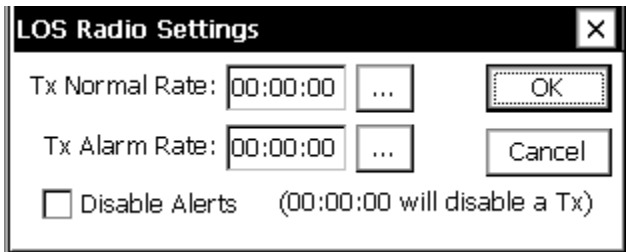

This is the LOS Radio settings screen. There are only three settings here. The Tx Normal Rate is the rate at which alarms are transmitted when no sensors are in alarm, and the Tx Alarm Rate which is the rate used when a sensor is in alarm. They can be set to 00:00:00 to inhibit timed alarm transmissions. Disable Alerts may be checked to prevent messages to be sent out the port when the system enters the alert state.

The LOS Radio only supports sending alarms to PC Base Stations using SSP (Sutron Standard Protocol).

The SSP and RS-485 options are very similar to the LOS Radio option. The primary difference being that SSP assumes a direct (SSP Only) serial connection between two devices, and RS-485 assumes there is an RS-485 connection. The difference is in how the control lines are used, but the options are the same.

## Data Modem Settings

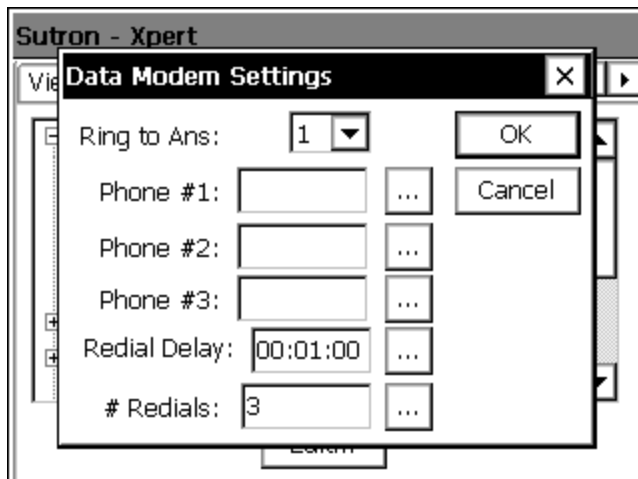

This is the Data Modem settings screen. When an alert occurs each phone number is tried in sequence starting with Phone #1, until an acknowledgement occurs. Or until the # Redials has been attempted on each number. The redial delay causes a pause between each redial attempt.

The Data Modem connection support two types of alarm messages. If a PC Base station is detected, an SSP alarm is sent, otherwise a simple text message is sent and a prompt is made asking for the alarm to be acknowledged.

## EzSetup Measurements

EzSetup is used to define simple sensors based on a measurement interval. Sensors configured here may be measured or averaged on a regular interval, have a simple slope and offset applied, displayed on the front panel, transmitted via Satlink or modem and be used to identify alarm conditions. It is possible to configure an entire station using only this section for sensors, if no special processing is needed.

Measurements that are set up in EzSetup work in parallel with measurements set up in the Graphical Setup. Hence, one popular practice is to set up simple sensor configurations in EzSetup, and more complicated sensor configurations in Graphical Setup.

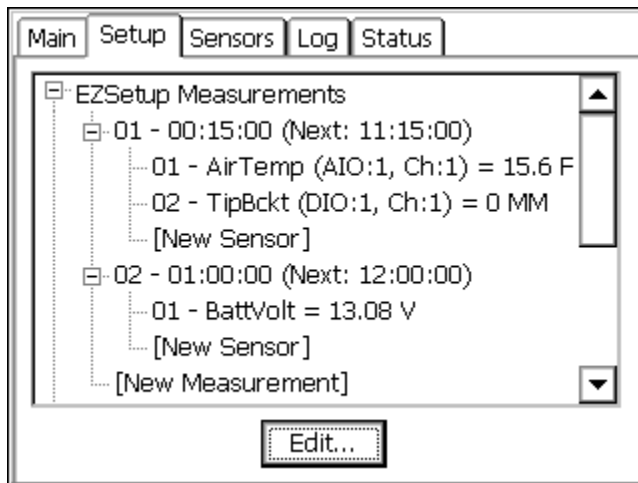

EzSetup organizes sensors by measurement schedule, similar to the way the 8210 data logger worked (though the 9210 can have multiple measurement schedules). Each measurement schedule has a set of sensors assigned to it. Whenever the measurement schedule executes, the sensors are measured.

In the example above, two measurement schedules have been defined. The first schedule will measure “AirTemp” and “TipBckt” every 15 minutes. The second will measure “BattVolt” every hour. You can see the next measurement of AirTemp and TipBckt will occur at 11:15:00, and that the last measured values for each of these parameters were 15.6F and 0MM. Note: this status information does not update automatically. To update, select the root entry “EZSetup Measurements”, and press the “Refresh” button.

Editing a measurement or sensor requires recording to be turned off. When you try to create or edit a measurement or sensor, the system will prompt you to stop recording. When the create or edit is complete, the system will prompt you to restart recording.

The measurements and sensors you define in EzSetup are stored in the 9210 setup file. If a setup file has been defined, it is saved automatically after making changes to EzSetup and leaving the Setup tab. You may also explicitly save the setup by selecting the “Setup” entry, and pressing the “Save As” button.

## Measurement Schedules

To create a new measurement schedule, select the “[New Measurement]” entry and press the “Edit” button. To edit an existing measurement, select the entry in the tree and click “Edit”. To delete a measurement schedule, select the entry and click “Delete”. When creating or editing a measurement schedule, the following dialog is shown:

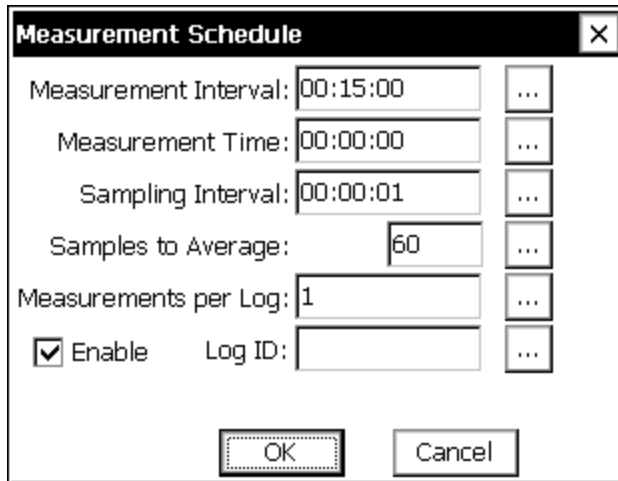

**Differences from an 8210:** Editing an EzSetup measurement is very much like the measurement schedules on the 8210 with a few differences. The 8210 has two fields named Power Time and Sampling Time which are not supported, and the order of processing has also been changed a little. Specifically, on the 9210, all the non-averaged sensors are measured first, so these measurements occur as close as possible to the measurement time. Then averaging starts immediately following, and continues until either the “Samples to Average” is exceeded or the average time has expired. The average time expires when the next scheduled Measurement Interval is to start or the sampling window defined by the Sampling Interval and Samples to Average is exceeded.

**MEASUREMENT INTERVAL:** Specifies how often the measurement is performed.

**MEASUREMENT TIME:** Specifies when the measurement is performed. This is can be viewed as an offset into the measurement interval and will typically be 00:00:00 as shown above. Setting it to 00:05:00 would cause the measurments to occur at 5 minutes, 20 minutes, 35 minutes, and 50 minutes past the hour. In other words, at 00:05:00 and every 15 minutes thereafter.

**SAMPLING INTERVAL:** For sensors with averaging enabled, the sampling interval specifies the timing between samples. Note: This should be at least as long as the time required to take the samples. If not, the “Samples to Average” takes on a new meaning described below.

**SAMPLES TO AVERAGE:** Specifies how many samples to take in averaging a sensor. Note: The sampling interval along with the samples to average defines a sampling window over which the samples will be taken. Sixty samples taken at a one second interval defines a sixty second sampling window. In situations where the sampling interval is shorter than the time required to take the samples, the unit will take consecutive samples for the duration defined by the sampling window. In other words, if an SDI-12 sensor that took 2 seconds was being measured by the above setup, the averaging would be for 60 seconds (00:00:01 times 60) instead of 120 seconds



needed for 60 samples. The unit must collect over half of the samples before the average will be marked with a “G” as good.

**MEASUREMENTS PER LOG:** Allows extra measurements to be taken which are not all logged. For instance, a value of 4 with a 00:15:00 interval would cause the 9210 to measure every 15 minutes, but log the specified sensor only every hour.

**ENABLE:** This button is a quick way to disable a measurement if there’s a temporary issue that doesn’t warrant completely deleting it.

**LOG ID:** When this field contains a string, all sensors associated with this measurement are logged as a group, with the Log ID used as the data set’s name. When the Log ID field is empty, all items are logged separately, each with it’s own time stamp, units, and quality data. NOTE: The maximum size of a log entry is 2048 bytes. Hence, be careful to not create a Log ID that results in an entry larger than that. Also note that only 256 bytes of data can be shown for each log entry on the Log tab. Of course, all 2048 bytes are included in an export of the log.

After creating or editing a measurement schedule, it’s tree entry is shown collapsed. Expand the entry by clicking the "+" plus sign. This will show all the sensors assigned to the schedule. The order in which the sensors appear is important, as it determines the order in which the sensors are measured and logged.

## Sensor Configuration

A new sensor is added to a measurement schedule by selecting “[New Sensor]” and pressing “Edit”. To edit an existing sensor, select the entry and press “Edit”. To delete a sensor, select it and press “Delete”. When creating or editing a sensor, the following dialog is shown:

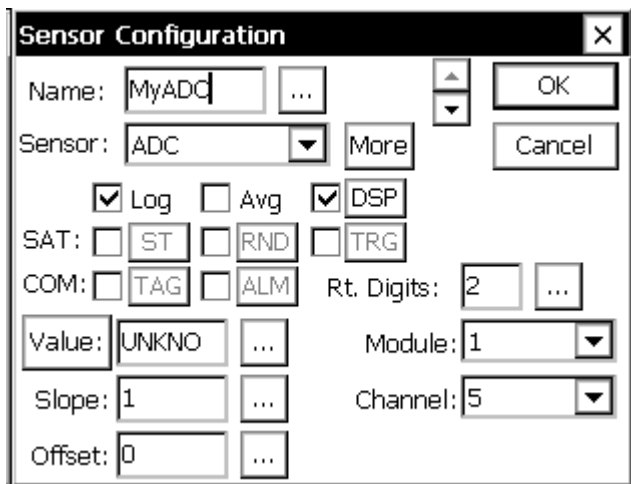

Use these arrows to move quickly between all sensors assigned to the current measurement

**NAME:** The name used when logging (except when Log ID is active), and when displaying the sensor value (in the EzSetup menu, the Sensors Tab, and the 9210 front panel display).

**SENSOR:** Defines the sensor type to measure. Click the box to see the list of all possible sensor types. Note that each of these sensor types corresponds to a sensor block that can also be used in the graphical setup. This means that all the descriptions for sensor blocks in Appendix A apply to the sensor type you select here.

**MORE:** This button brings up the configuration dialog for the selected sensor. See Appendix A for details on how to change the configuration. Note: Most sensors have many more important settings than can be shown on the EzSetup Sensor Configuration dialog. The additional settings are accessed by pressing “More”.

**LOG:** When checked, the system logs the output to ssp.log. Logging to ssp.log, as opposed to a log specified by the user, ensures the data is available through legacy telemetry channels. When ssp.log does not exist, the user is prompted to create it when leaving Setup.

**AVG:** When checked, the system averages the sensor according to the sampling schedule defined in the measurement schedule. **NOTE:** When using EzSetup to average both speed and direction of either the RMYoung or GillWind sensors, the system computes a **unit vector** average of wind direction, and a **scalar** average of wind speed. However, this is only the case when the sensors have been set-up properly, where the system considers speed and direction as coming from the same sensor (i.e., the sensor outputs are “linked”). You can verify proper setup by ensuring the speed and direction parameters are grouped together under the sensor entry. The following shows a proper setup for RMYoung.

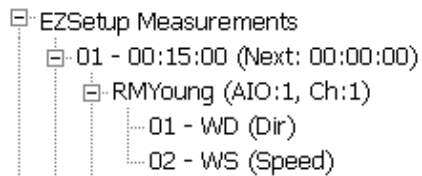

See the section “Multi-Output Sensors” for more information on how to ensure sensors with multiple outputs are set up properly.

**DSP:** When checked, the sensor will be included when displaying current values from the 9210 front panel. Pressing the DSP button will bring up a dialog that allows you to change the name and precision of the value shown on the front panel.

**SAT-ST:** Checkbox enables Self Timed transmissions for this sensor. Clicking the ST box will bring up additional properties; see Self-Timed Parameter block in Appendix A for details on settings.

**SAT-RND:** Checkbox enables Random transmissions for this sensor. Clicking the RND box will bring up additional properties; see Random Parameter block in Appendix A for details on settings.

**SAT-TRG:** Checkbox enables this sensor to trigger random transmissions. Clicking the TRG box will bring up additional properties; see Random Group block in Appendix A for details on settings.

**COM-TAG:** Checkbox enables this sensor for Coms (SSP/CL). Clicking the TAG box will bring up additional properties; see Coms Tag block in Appendix A for details on settings.

**COM-ALM:** Checkbox enables this sensor for alarms via Coms (SSP/CL, e.g., modem, LOS, etc.). Clicking the ALM box will bring up additional properties; see Coms Tag block in Appendix A for details on settings.

**VALUE:** The Value box shows the last measured value for the sensor. Press the value button to take a reading immediately and display it. Editing the value (by pressing ...) will modify the

Offset such that future readings will equal the entered value. Simply set the offset back to 0 to undo this.

**RT. DIGITS:** Sets the number of right digits used when displaying and logging the sensor.

**SLOPE/OFFSET:** The current slope and offset assigned to the sensor.

**MODULE/CHANNEL/PORT/ADDR:** These settings mirror those found in the sensor configuration dialog. The setting will appear only when the selected sensor type supports the property. For example, when the sensor type is ADC, the Module and Channel properties are shown in the Sensor Configuration dialog, as well as on the dialog that appears once “More” is clicked. Note: Most sensors have many more important settings than can be shown on the EzSetup Sensor Configuration dialog. The additional settings are accessed by pressing “More”.

**PARAMETER:** Appears when a sensor has more than one possible output. For instance an AT/RH sensor has both an air temperature, and a relative humidity output. Select the one to measure.

### Multi-Output Sensors

Several sensors have more than one output parameter to select for measurement. For example, the SDI-12 sensor offers output parameters 1 through 20, the RMYoung and GillWind sensors offer output parameters “Speed” and “Dir”, and the Counter sensor provides “Count”, “DeltaCount”, and “Freq” output parameters. When a sensor with multiple outputs is selected in the Sensor Configuration dialog, the dialog allows the user to select the output parameter to use (see “Parameter” in the dialog, below).

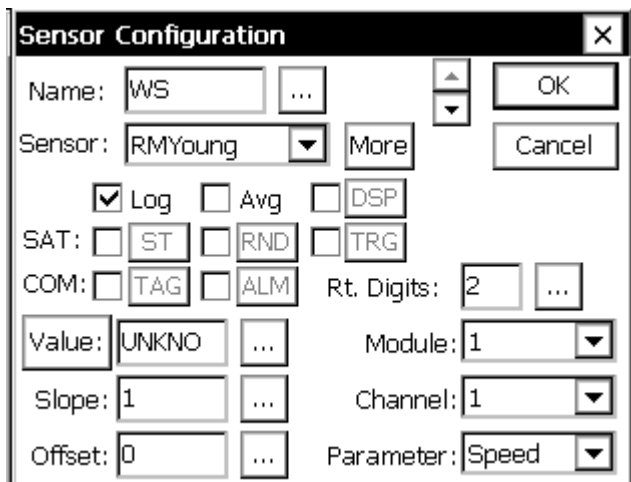

When you want to measure more than one output of a multi-output sensor, you must set up a separate sensor entry for each output to be measured. When each output is set up properly, the system makes only one measurement of the sensor, as opposed to a separate measurement for each output. This is especially important for sensors that take a significant time to measure (imagine taking 5 separate measurements to obtain 5 parameters from an SDI sensor that takes 30 seconds to measure!). In addition, for some sensors, it may be important to ensure parameters were measured at the same time.

To ensure only one measurement is made for all outputs of a single sensor, **the I/O device configuration for each sensor entry representing a separate output, must be the same.** The I/O device configuration consists of different parameters for different types of sensors. If the sensor reads an analog input, then the analog input's module and channel must be the same. If the sensor reads a com port to obtain its input, then the com port must be the same. For SDI-12 sensors, the SDI-12 address and command must be the same. Note: the I/O device configuration must be set the same **when creating the sensor entry.** Changing the configuration to be the same after the entry has been made, does not result in "linking" any outputs.

In the example below, the Dir and Speed outputs of the RMYoung sensor are linked. One measurement of the sensor will be made every 15 minutes to obtain both values, Dir and Speed. The same is the case for the GillWind sensor on COM4. However, the GillWind sensor on COM5 does not have its outputs linked. This would happen if, for example, the Speed sensor entry was created with the selection of COM7 and then changed to COM6 to match the Dir entry.

```

01 - 00:15:00 (Next: 00:00:00)
├── RMYoung (AIO:1, Ch:1)
│   ├── 01 - WD (Dir)
│   └── 02 - WS (Speed)
├── GillWind (COM4:)
│   ├── 03 - WD (Dir)
│   └── 04 - WS (Speed)
├── 05 - Dir (COM6:)
└── 06 - Speed (COM6:)

```

Once outputs are linked, **a change to one will affect all linked outputs.** Using the above as an example, if you select the GillWind Dir entry and change its com port to COM3, it will change for the Speed setting as well.

Once an output has been linked, you must delete the entry to "unlink" it. Hence, to fix the fact that the Speed output of the GillWind sensor on COM6 is not linked to the Dir output, you would first delete the Speed entry, and then re-add it, making sure to set the com port setting to COM6 in the process.

## Event Driven Sensors

The vast majority of sensors measure when told to, i.e., according to the measurement schedule you define. The exception to this rule occurs when using a sensor with an *Event* option checked (like BinIn). Every time an *Event* occurs, the entire set of sensors defined under the measurement schedule will be measured. For example, if you had an EZSetup measurement schedule with the BinIn block (*Event checked*) and an sdi-12 sensor, every time the BinIn detected a change of state, the SDI-12 sensor would also be measured.

## Graphical Setup

The *Graphical Setup* branch of the Setup tab is used to manage the portion of the system's setup that has been defined by interconnecting graphical blocks, where each block represents a function such as sensor, measure, or log. This method of setup should be used to define sensors

that can't be setup using the *EZSetup Measurements*. This would include sensors that need to have a polynomial, interpolation table or any other special processing done to them.

See the section in Appendix A that covers Processing blocks to see all the available processing. See Chapter 4: Setup Diagrams, for detailed descriptions of how to set up sensors in this way.

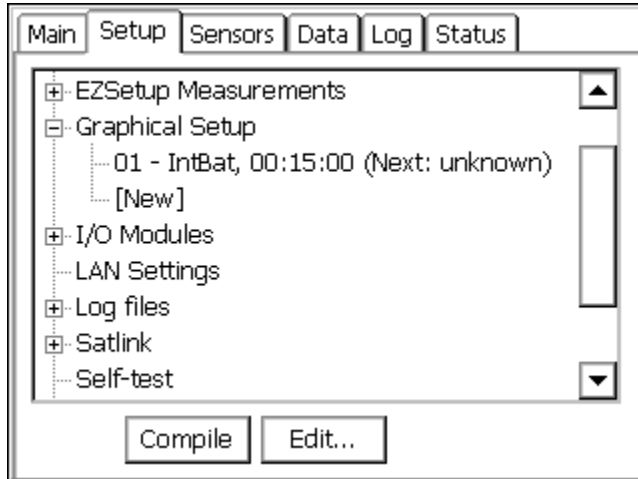

The details of whatever measurements have been graphically defined will be displayed underneath the *Graphical Setup* main branch. Some of the details shown for each measurement include: sensor name, channel usage, last data value and quality (quality only if it is bad), and scheduling information, including the time of the next measurement.

Selecting a measurement sub-branch and pressing *Edit* will cause the system to display the measurement graphically, i.e., in terms of the blocks that define it. Only the blocks of the measurement selected will be displayed.

To display the blocks of all measurements that have been defined graphically, select the *Graphical Setup* branch and press *Edit*.

Press the *View* button to view the block diagram in read-only mode.

To define a new measurement graphically, select [New] and press *Edit*. This causes the system to display the graphical setup page with no blocks yet defined.

To remove an entire graphical block chain, click it, click *EDIT* and then click the left most block and do a delete right.

## I/O Modules

The I/O modules branch displays the I/O modules currently connected to the system. These modules are used for hooking up all sensors to the system except SDI-12 sensors. Up to ten modules can be stacked together and then plugged into the I2C port at the bottom of the logger. Specific details on individual modules can be found in Appendix C.

Select an I/O module in the *Setup* tab and press *Edit...* the following dialog will appear. This dialog gives the serial number of the I/O module, its name and its I2C address. Only the I/O module number can be changed. This number is stored into the flash of the I/O module, so it remembers it on power cycles.

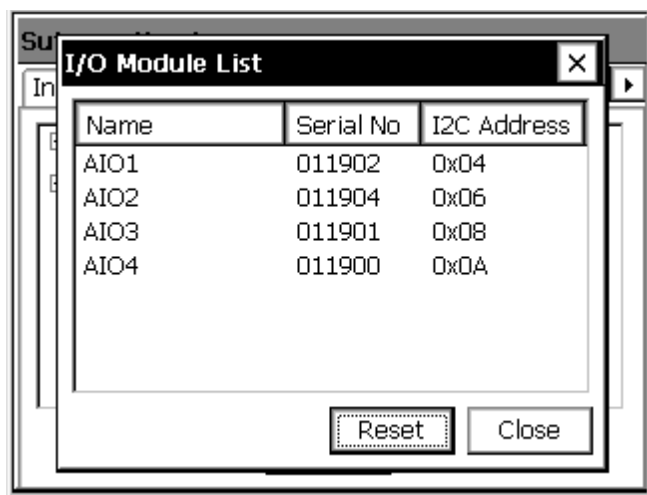
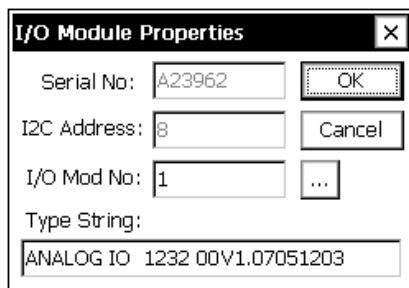

**NOTE:** All I/O Module Names must be unique (see above screen shot). If not unique, change the module number as described in the Naming I/O Modules section below.

### Naming I/O Modules

An I/O module name consists of a three character descriptor indicating module type that cannot be changed plus a unique module number. The number of the module can be changed. The system utilizes the more descriptive modules names, AIO1 (Analog I/O Module #1), AIO2 (Analog I/O Module #2), to differentiate between modules when setting up measurements rather than having to specify serial numbers. The generic and user changeable naming of the modules also simplifies the process of changing one module for another. The system must not have more than one type of module with the same number, I.E. If a system has two analog modules both modules cannot be module number one, but it is possible to have a digital module one and an analog module one.

### Resetting I/O Modules

Pressing *Reset* will “reboot” the I2C bus, it is similar to disconnecting and reconnecting the modules. This is only needed if a module that is connected does not show up in this list.

### LAN Settings

The *LAN Settings* branch of the *Setup* tab enables you to control power to the LAN (ethernet). To display the LAN Settings dialog, select the *LAN Settings* entry and press the *Edit...* button. The following dialog displays:

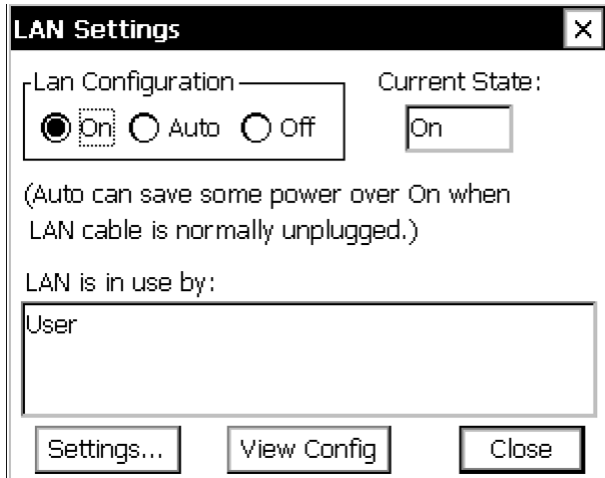

The *Lan Configuration* buttons (*On*, *Auto*, and *Off*) determine the state of the LAN when the 9210 first boots. *On* causes the LAN to be turned on at boot. The LAN stays on until explicitly turned off. *Auto* turns the LAN on only when something is connected to the ethernet jack. *Auto* is typically only set when you plan to connect your PC or laptop directly to the 9210 (which requires a special ethernet *crossover* cable; see below). When *Auto* is selected and a device is not connected to the ethernet port, the system draws only about 1mA more power than if the state was set to *Off*.

The *LAN is in use by* area displays the list of elements that have requested the LAN to be on. This area will show “User” when the LAN Configuration setting is On, “Modbus” when a modbus process has requested the LAN to be on, and so on.

Press the *View Config* button to view details (IP address, DNS server, etc.) about the current connection.

When you press the *Settings...* button, the system will ask whether you want to run the Network Wizard, which will ask several questions and then set LAN settings based on your answers. If you answer No to running the wizard, you instead are prompted with a dialog from which you can manually configure network properties.

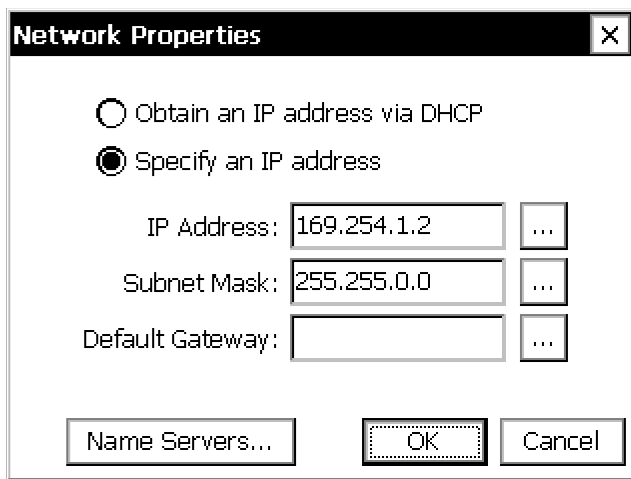

The Network Properties dialog is used to specify how the 9210 gets an IP address. Typically, when the 9210 is connected to a network that provides DHCP services, select “Obtain an IP address via DHCP”. If DHCP services are not available, or if you desire a static IP address for other reasons, select “Specify an IP address”, and enter the IP address and Subnet Mask. You can press the *Name Servers...* button to enter DNS and WINS address information, if desired.

## Crossover Connections

An ethernet crossover cable is a special kind of ethernet cable that acts similar to a null modem cable where TX and RX are crossed in order to facilitate host to host communications. The crossover cable allows you to connect the 9210 directly to a PC or laptop, without the need for a router between the two. This cable can be purchased most anywhere standard ethernet cables can be purchased.

When using a crossover cable, set the LAN Configuration either to *On* or to *Auto*. As mentioned above, *Auto* will turn the LAN on and off automatically according to whether there is something connected to the ethernet jack.

Since there’s no router in a crossover connection, it’s best to assign a static IP. If you don’t, the 9210 will still assign a default IP that Xterm can find and use, but the connection process occurs more slowly.

## Log Files

The *Log Files* branch of the *Setup* tab allows management of all the log files that have been added to the system. Multiple log files can be stored in physical memory space, only limited by the amount of memory in the system. Multiple files can be open at one time; therefore, ten sensor signals can be logging to ten separate files (or to five files or one for that matter).

To display a more detailed listing of the log files in the system, click *Log files* and then press the *Edit...* button at the bottom of the screen:

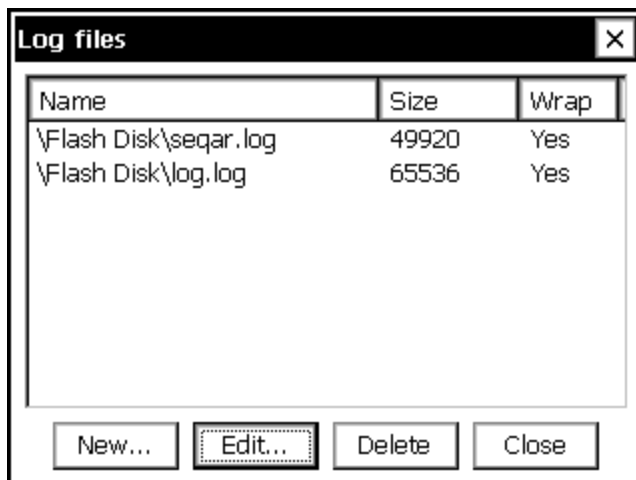

## Log Properties

For each log file, this window lists the name of the file (\\location\\name.log), the size of the file, and whether or not the file should wrap. You can create a new dialog by pressing New, or edit



the properties of a log file by highlighting the file and pressing “Edit...”. In both cases, the following dialog is shown:

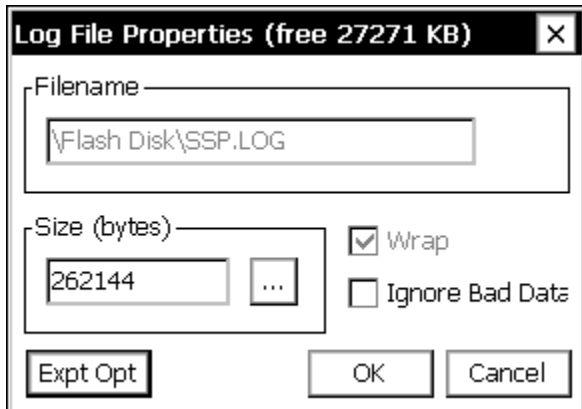

The file size is the maximum size of the log file in bytes.

Wrap specifies what should happen once the file has been filled up to its maximum size. If wrapping is set to ‘Yes’ and the file fills up, the system will delete some of the old data to make room for the new data. This way the log file will always be full of the most recent data.

If wrapping is set to ‘No’ and the file fills up, the system will not store the additional data in the log and the new data will be lost. Note that Wrap can only be set when creating a new log.

"Ignore Bad Data", when checked, means don't log any data unless it has good quality ("G").

Pressing the "Expt Opt" button will bring up the Export Log Options dialog. See below, for a description of this dialog.

### Creating New Logs

When creating a new log, it might take a minute or two after pressing OK for the file to be initialized. During this time, nothing else can be done with the unit (an hourglass is displayed during log file creation).

On SD cards with Gigabyte capacities, creating larger log files will take MUCH longer. To create a 100 megabyte (104857600 bytes as entered) log file, the unit will take about 7 minutes, to create a 1 Gigabyte log file, expect the unit to be busy for over an hour.

Use \\Flash disk\\filename.log to store log files into internal flash.

Use \\USB Card\\filename.log to store file onto a USB “thumb drive”.

Use \\SD Card\\filename.log to store file onto an SD storage card.

### Sizing Logs

Since each logged data point takes between ten and fifteen bytes of memory, a log file 60,000 bytes in size will hold between 4000 and 6000 data points, or between 1.5 and 2 months of a single sensor measurement, made every 15 minutes.

You can change the size of an existing log from the Log File Properties dialog. The size can be increased without losing any data currently in the log. If the size is decreased, you will lose some

of the data in the log. **If you are decreasing the size of the log, you may want to retrieve the data from the log so it is not lost.**

Note: the minimum log size is 2048 bytes. The maximum log size is the lesser of 1) 2 billion bytes, or 2) the free space available on the storage medium minus a small safety buffer (32k for storage cards, 192k for Flash Disk).

### Export Log Options

Pressing the “Expt Opt” button on the Log File Properties dialog brings up the following dialog, used to define options related to exporting a log file.

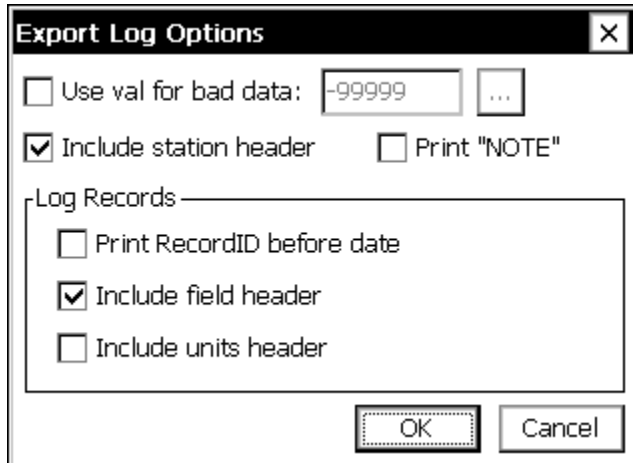

When “Use val for bad data” is checked, all data marked with Bad quality (“B”), is replaced with the supplied value on export.

When “Include station header” is checked, the export will contain a header containing the station name. This makes it easy to identify which station the export came from.

When “Print NOTE” is checked, log notes will be exported (and displayed in log tab) with NOTE in the sensor field and the note text in the data field. By default this option is not checked, meaning “NOTE” is not printed, and the note text is displayed in the sensor field.

When “Print RecordID before date” is checked, the RecordID field for all log records, if any, is printed before the date and time.

When “Include field header” is checked, the exported file contains a header describing the format of each log record field, if any.

When “Include units header” is checked, the exported file contains a header that lists the units assigned to each log record field, if any.

### ***Example Header***

Here’s an example of a header that includes the station name, as well as field and units headers:

Station Name  
Xpert  
Date, Time, RecID, AT, RH, HeatFlux, Esen, Dielectric, Moisture, NetRad, SoilTemp  
mm/dd/yyyy, HH:MM:SS, C, %, W/m2, uV/W/m2, %, W/m2, C  
01/27/2012, 16:39:00, Default, 155.47, 100.00, 0.00, 0.00, 0.00, 0.00, 0.00, 0.00  
01/27/2012, 16:39:30, Default, 154.82, 100.00, 1829.85, 42.69, 380.42, 229.92, -27847.42, -24.36

## Satlink

The *Satlink* branch is used when a Sutron Satlink transmitter is connected. This branch is used to manage the details of the setup for both self-timed and random transmissions.

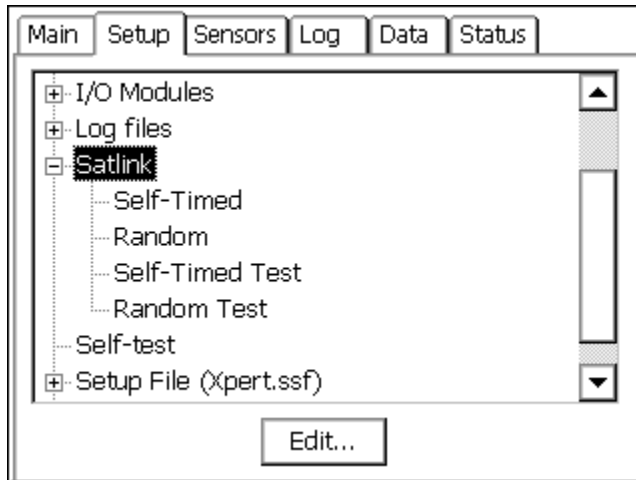

## Satlink Dialog

Selecting Satlink and pressing Edit brings up the main Satlink dialog.

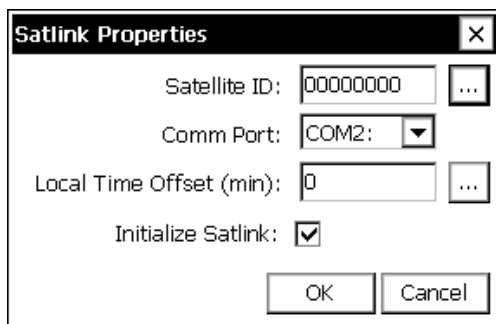

## Satellite ID

This property is the *Satellite ID* for both self-timed and random transmissions. The *Satellite ID* is a hexadecimal number, 8 digits long, assigned by NESDIS, EUMETSAT or some other authorizing agency.

## Comm Port

The *Com Port* property identifies the COM port to which Satlink is connected. Satlink connects to the comm. port using a standard DB9 serial cable.

## Local Time Offset

The *Local Time Offset* property defines the difference between the current local time and UTC (Universal Time Coordinated). This offset is sent to Satlink at recording start. The offset is specified in number of minutes, and may be negative. The 9210 uses the local time offset and the UTC time received from Satlink to set the 9210's clock. In addition, the offset is sent to Satlink (Satlink 2's use this value to determine local time).

## Initialize Satlink

The *Initialize Satlink* check box controls whether or not to send transmission settings to Satlink at the start of recording. When this box is checked, the transmission settings (times, rates, channels, etc.) are sent to the Satlink whenever the unit is started, otherwise, settings are not sent to the Satlink, but assume instead that Satlink has been configured by some other program (e.g., *Satlink Communicator*).

## Self-Timed Dialog

The Self-Timed dialog allows the setting of the Self-Timed transmission properties. The properties correspond to settings that will be sent to Satlink to configure it as well as settings that will be used to make the transmission. A typical dialog is shown below followed by a brief explanation of each property.

The screenshot shows a dialog box titled "Self-Timed Properties". It contains the following controls:

- Enable Self-Timed:
- Center in Window:
- Channel:  ...
- Num Vals:  ...
- Format:  ▼
- Type:  ▼
- Append Lat/Lon:
- Append Batt Voltage:
- Time:  ...
- Rate:  ...
- Window:  ...
- Antenna:  ▼

Buttons at the bottom: More..., OK, Cancel.

### Enable Self-Timed

This box must be checked for the system to make self-timed transmissions. This field is sent to the Satlink to configure it and uses the field to control its own scheduling.

### Center in Window

This box instructs Satlink to center each timed transmission in the transmission window. Normally, a transmitter has a transmission window that is larger than the length of the transmission it must make. When "Center in Window" is selected, Satlink will delay each

transmission so it is centered in the window. The Window size is entered in the Window Property on this dialog.

### **Append Lat/Lon**

Satlink transmitters have a GPS (Global Positioning System) receiver which is capable of determining its latitude and longitude. This check box instructs Satlink to add the Latitude and Longitude to the end of each transmission.

### **Append Batt Voltage**

This check box configures Satlink to append the loaded Battery voltage (taken at last TX) to the end of the transmission.

### **Channel**

This property defines the channel that Satlink will use to make the self-timed transmission.

### **Num Vals**

This property defines the number of values to include in the self-timed transmission. This value is used only in the BIN-INT transmission format to set the number of values to send for each sensor (e.g. if set to 32, and if 4 sensors are sending data, then a total of 128 data values are sent). Other formats may use the NUM VALUES defined in the self-timed blocks entered into the setup. The number entered here will also set the default value when placing a self-timed block into the setup.

### **Format**

Support for several standard formats is included. The supported formats are:

“SHEF” format conforms to NESDIS Standard Decimal format specifications. The format is ASCII and readable by persons without the aid of a computer.

“SHEF Fixed” is a special version of the SHEF format where numbers are fixed to seven decimal points. Receive sites that handle messages with variable length data can use this format.

“Bin Int” is a binary interleaved format, identical to the 8210 binary transmission format. The data are in the 6-bit pseudo binary format required by NESDIS.

“Bin NonInt” is a binary non-interleaved format. This format also uses the 6-bit pseudo binary format but allows different amounts of data to be sent for each sensor. The data is not interleaved, i.e., one sensor’s data set appears together in the transmission.

“NOS” conforms to NOS requirements for its tidal stations.

“NFDRS” conforms to NFDRS requirements for its fire weather stations.

“INSAT” conforms to INSAT requirements for its stations.

"HANDAR" is a format where sensors are separated by <CRLF>, sensor data is separated with a space and missing data is an "M". The oldest data is first (to left), as in:

```
010034380517419:21:30G42+0NN155E9200070"  
1.3 1.3 1.3 1.3  
2.4 2.4 2.4 2.4  
M 12.2 12.2 12.2 12.2 12.3 12.3 12.3
```

## Type

The Type property defines the satellite type and baud rate for the transmission. You can select from GOES 100 (CGMA 100 INTI), GOES 300, GOES 1200, as well as MSG (for METOESAT), INSAT, and others.

## Time

Time is the transmission time assigned to the station. Each station will have a unique transmission time, rate and channel assigned by NESDIS, EUMETSAT or other authorized agency. The transmission time is entered in UTC.

## Rate

The Rate, along with the transmission time determines when transmissions are made. The units for the rate are HH:MM:SS. Typical rates are 01:00:00 for hourly transmissions and 04:00:00 for transmissions every 4 hours.

## Window

This property defines the size of the window, in HH:MM:SS, that is given for the transmission. Satlink only uses this window size if the box “Center in Window” is checked.

## Random Dialog

The Random Dialog allows the setting of the Random transmission properties. Random transmissions are those that are made at random intervals. The properties correspond to settings that will be sent to Satlink to configure it as well as settings that will be used by software to make the transmission. A typical dialog is shown below followed by a brief explanation of each property.

The screenshot shows a dialog box titled "Random Properties". It contains the following fields and controls:

- Enable Random:
- Append Lat/Lon:
- Append Quality:
- Norm Rt: 12:00:00
- Channel: 151
- Alarm Rt: 01:00:00
- Type: 100 bp
- Burst Rt: 00:01:00
- # Burst: 3
- Format: Bin Int
- # Values: 3

Buttons: OK, Cancel

## Enable Random

This box must be checked for the system to make random transmissions. This field is sent to the Satlink to configure the transmitter and uses the field to control its own scheduling.

## **Append Lat/Lon**

Satlink transmitters have a GPS (Global Positioning System) receiver which is capable of determining its latitude and longitude. This check box instructs Satlink to add the Latitude and Longitude to the end of each transmission.

## **Append Quality**

This check box configures Satlink to append quality data to the end of the transmission. Note: as of version 4.11 of Satlink, Satlink has not yet implemented this function.

## **Norm Rt**

The “Normal Rate” property defines how often random transmissions will be made, when the unit is not in alarm. The rate is specified in HH:MM:SS.

## **Alarm Rt**

The “Alarm Rate” property defines how often random transmissions will be made when the unit is in alarm, following burst transmission(s). The rate is specified in HH:MM:SS.

## **Burst Rt**

The “Burst Rate” property defines how often the “# Burst” random transmissions will be made. These burst transmissions occur when the unit first goes into alarm. The rate is specified in HH:MM:SS.

## **Format**

Several formats are supported for random transmissions:

“Bin Int” is a binary interleaved format, identical to the 8210 binary transmission format. The data are in the 6-bit pseudo binary format required by NESDIS.

“Bin NonInt” is a binary non-interleaved format. This format also uses the 6-bit pseudo binary format but allows different amounts of data to be sent for each sensor. The data is not interleaved, i.e., one sensor’s data set appears together in the transmission.

## **Channel**

This property defines the channel that Satlink will use to make the random transmission.

## **Type**

This property defines the baud rate for the transmission. The valid selections are 100 and 300.

## **# Burst**

The “# Burst” property defines how many transmissions Satlink will make when the unit first goes into alarm. This value is normally set to one. When set to a value other than one, Satlink will make this number of transmissions with each transmission separated by Burst Rate number of seconds.

## # Values

This property defines the number of values to include in the random transmission. This value is used for the BIN-INT transmission format to set the number of values to send for each sensor (E.G. If set to 32 and 4 sensors are sending data, then a total of 128 data values are sent), other formats will use the NUM VALUES defined in the random parameter blocks in the setup. The number entered here will also set the default value when placing a random parameter block into the setup for BIN-NONINT format.

## Self-Timed Test

The Self-Timed Test dialog is used to make a test transmission, see the selected format of a self-timed transmission and see the detailed status of the transmitter. Pressing the Send button makes test transmissions. Before pressing *Send*, Satlink must be set up with valid information on both the Satlink dialog and Satlink self-time dialogs. Test transmissions should only be made on special test channels, or with the Satlink connected to a dummy load. Otherwise, the transmission may interfere with other stations. The test message that will be sent is displayed in the text box to the left of the send button. Change the message by selecting custom and then changing the message using the ... control.

If the setup has been entered, this dialog will display the Current Message that would be transmitted if one were sent by the system. Along with the message, the dialog displays the number of characters in the message and the amount of time that would be needed to make the transmissions. These will be useful things to examine to help make sure the set-up is correct.

To see the detailed status from the transmitter, press the Status button.

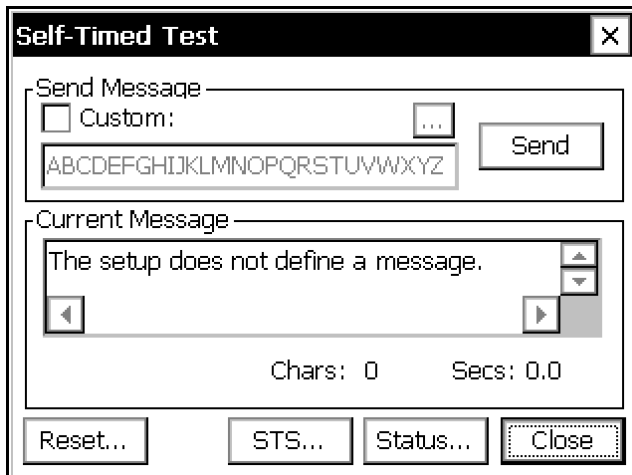

Pressing the “Reset” button will send a command to the Satlink to reset (reboot). This might be necessary in the rare case where the Satlink has a problem that can only be cleared by reset, but no one is at the station do cycle power.

To send a Send-to-Sutron test message, press the *STS...* button. The following dialog is displayed allowing an STS transmission to be made.



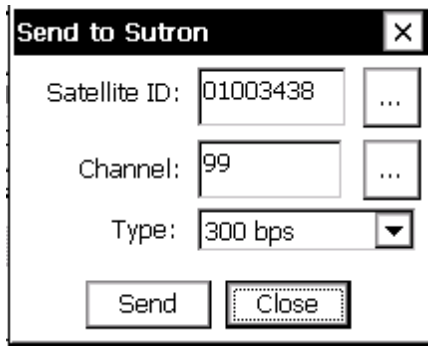

## Random Test

The Random Test dialog is used to make a test transmission, see the selected format of a random transmission and display the detailed status of Satlink. Pressing the Send button makes test transmissions. Before pressing *Send*, Satlink must be set up with valid information on both the Satlink dialog and Satlink random dialogs. Test transmissions should only be made on special test channels, or with the Satlink connected to a dummy load. Otherwise, the transmission may interfere with other stations. The test message that will be sent is displayed in the text box to the left of the send button. Change the message by selecting custom and then changing the message using the ... control.

If the setup has been entered, this dialog will display the Current Message that would be transmitted if a random message were sent. Use the control next to Group to select which random group to see formatted. Along with the message, the dialog displays the number of characters in the message and the amount of time that would be needed to make the transmissions. These will be useful things to examine to help make sure the set up is correct.

To see the detailed status from the transmitter, press the Status button.

Pressing the “Reset” button will send a command to the Satlink to reset (reboot). This might be necessary in the rare case where the Satlink has a problem that can only be cleared by reset, but no one is at the station to cycle power.

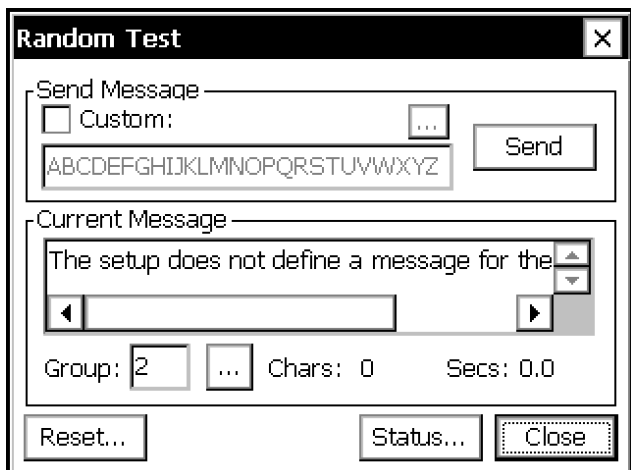

## Satlink Status

Satlink keeps a detailed status of its present and past operations. The 9210 will display this information in the Satlink Status dialog.

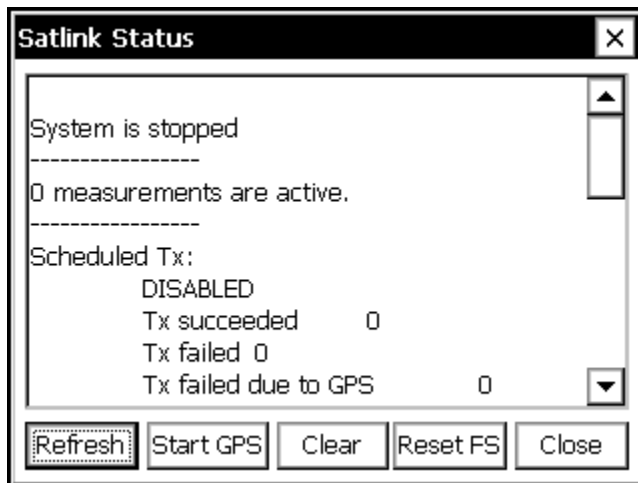

The *Refresh* button is used to update the status data displayed. The *Start GPS* button is used to manually start a GPS Sync session (note, Satlink typically manages GPS sync for you). The *Clear* button is used to command Satlink to clear its status counters and error messages. The *Reset FS* button is used to command Satlink to reset its failsafe. Press *Close* to close the dialog.

## Self-test

The *Self-test* branch in the Setup tab is used to manage the self-test routines built into the software. Self-test runs at startup or when the RUN button is pressed in the dialog. When it runs, a file named test\_results.txt is created as a place to preserve the test results. As long as this file exists in \flash disk, the self-test routines will run each time the system starts and will continue running until stopped by the user.

The self-test routines prompt for user input or acknowledgment at several points in the test. If there is no user input, the tests will repeat automatically. At the end of each test cycle, the system prompts to repeat the tests or exit. The user is also given a chance to delete the test results file, which will prevent the tests from being run again on the next system start.

The following tests are performed each time SELFTEST executes:

**Power Consumption:** provides opportunity for user to measure power consumption while the system is in its deepest sleep.

**Verify RTC Communication:** verifies communication with external RTC.

**Verify Physical Memory:** verifies the correct amount of memory is present.

**Verify Flash Disk:** verifies the correct amount of storage memory is present.

**Verify Watch Dog:** verifies the watchdog timer counter is counting within range.

**Verify COM ports:** verifies com port operation.

**Verify I2C Devices:** verifies expected I2C devices are present (Requires the presence of at least one I/O module to pass).

**Verify Display Buttons:** verifies the operation of the display buttons.

Verify Battery Voltage: verifies battery voltage is 12V +/- 2V.

Verify Xlite I/O: verifies I/O module functions.

Pressing the *Edit* button with the SelfTest branch selected brings up the following dialog that controls what optional tests are to be run.

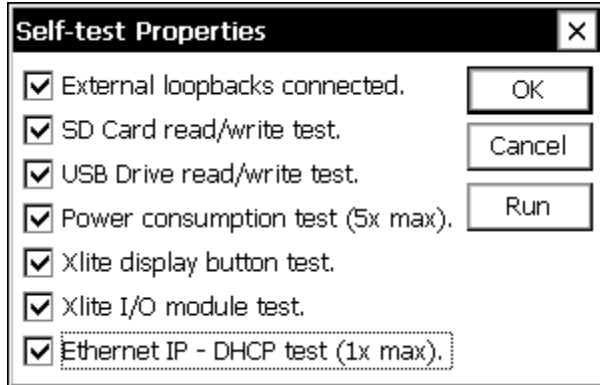

External loop backs connected – The system expects the following:

Null modem cable connecting COM2 and COM3.

Null modem cable connecting COM4 to COM5 (see Header B Connection Table below).

SD Card read/write test – Make sure an SD card is inserted when running this test.

USB Drive read/write test – Make sure a USB thumb drive is inserted when running this test.

Power consumption test – All test runs begin with this test. The system puts itself into deep sleep for one minute so that the user can measure power consumption. Note: this test only runs for up to 5 consecutive iterations.

Xlite display button test – The system prompts the user to press the three buttons on the Xlite display.

Xlite I/O module test – The system performs various tests on its I/O modules. This test suite requires the Xlite’s I/O modules be connected as follows:

| <b>Header A Connection Table</b> |  |
|----------------------------------|--|
| <b>Analog signal</b>             | <b>Connection</b>  |
| Ch1                              | Connect to middle of 10 Kohm and 10Kohm divider from Vref to GND |
| Ch2                              | 1 M to ch1   |
| Ch3                              | 100 K to ch 4  |
| Ch4                              | Connect to Vref  |
| Ch5                              | Connect to GND   |
| Ch6                              | 100 K to ch 5  |
| Ch7                              | Connect to ch 8  |
| Ch8                              | Connect to GND   |
| Ch9                              | 1 M to ch 10   |
| Ch10                             | Connect to VEX   |

| Header B Connection Table |  |
|---------------------------|--|
| Digital signal            | Connection   |
| In 1                      | Connect to I/O 2   |
| I/O 3                     | Connect to I/O 4   |
| I/O 5                     | Connect to In 8  |
| I/O 6                     | Connect to I/O 7   |
| RS-485A                   | Connect to middle of 3.9Kohm and 1Kohm divider from SW'D 12 to GND |
| SW'D 12                   | Connects to 3.9K resistor of above divider                         |
| RS-485B                   | SDI-12 Data  |
| SDI-12 DATA               | 1 Mohm resistor to SDI-12 +12                                      |

## Setup File

The *Setup File* branch in the setup tab is used to manage the setup file containing the system setup and configuration. The setup file contains all of the system's settings except for station name, Xpert display contrast settings, and log export historical data.

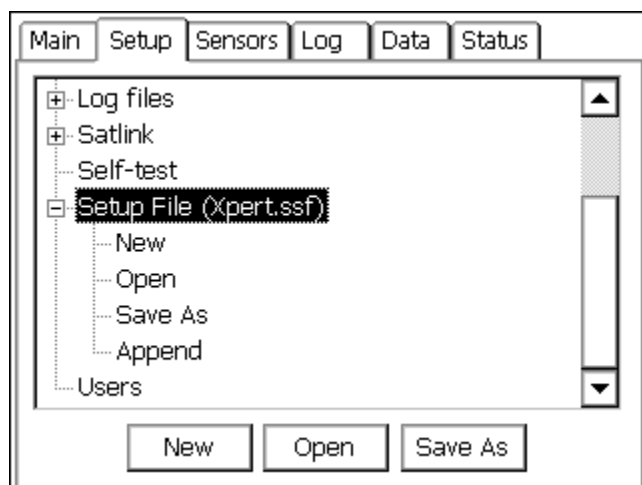

### New

The *New* option is used to reset all settings to a default state with a name specified by the user. After selecting *New*, the system prompts for the name of the new setup file. If the file specified exists, the system warns that it will be overwritten.

### Open

The *Open* option is used to open existing setup files.

### Save As

The *Save As* option is used to save current settings to a file with a different name. A large number of setups can be stored, limited only by the available Flash memory. To save a setup under a new name, select the *Save As* and click *Edit*. The following window will appear:

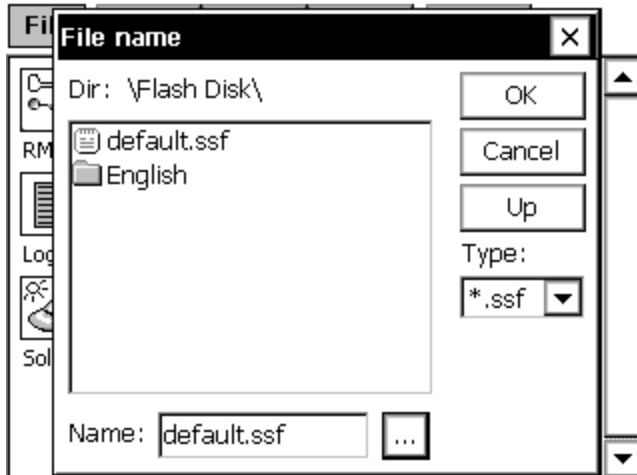

The *Up* button is used to move up one level in the directory tree structure. Use it to get to a USB storage device displayed as “\USB Card”, or to an SD storage card displayed as “\SD Card”. To change the filename for the setup file being saved, click the change button (“...”) and using the virtual keypad to enter the desired name of the file.

## Append

The *Append* option is used to append blocks from another setup file to the current one. Note that only blocks are appended. No other settings from the setup file selected are imported (e.g., Satlink settings remain unchanged after appending a new setup file).

Note: The system saves the setup file as changes are made so that it is never necessary to perform an explicit save (and, hence, there is no *Save* option).

## Users

The *Users* branch of the setup tab is used to manage the list of user login accounts to the system. Pressing *Edit* with this branch selected brings up a window with all the users accounts that have been added so far (it will be blank if none have yet been added.) From here, an account can be added, modified, or deleted.

The columns provide a summary of the settings including the name, group, timeout, and the access rights that have been permitted. In the screen below, Susan has been placed in the data Retrieval user group. She may leave the unit inactive for 1 minute before it will time out (applies only to remote command line login). She has been granted access rights to the Command line and Gui. Franco has been placed in the Setup user group and hence is allowed to change the setup, upgrade the unit, transfer files, etc. He may leave the unit inactive for up to 10 minutes before his session will timeout. He has been granted access rights to the Command line, Gui, and he may access the unit via TCP/IP (LAN).

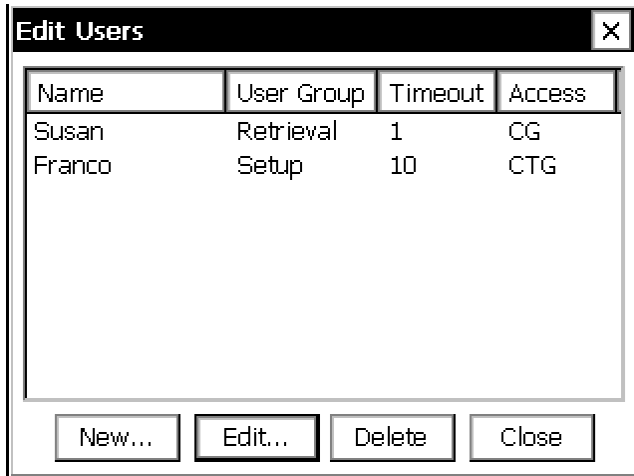

Pressing *New...* or *Edit...* brings up a user properties window. This window has blanks for user name, password, user group, access rights, and a timeout.

If no password is desired for that user, simply leave the password spaces blank.

The user group determines what sort of access the user is allowed. Normally either Retrieval and Setup access are selectable, but Custom groups may also be enabled by certain SLLs or Basic Programs.

A timeout period may be selected for the user to determine how much time with no activity must pass in order to automatically log-out the user.

Starting with 9210 firmware v3.2, Access Rights may also be assigned. These allow the user to be restricted to accessing only the Command Line, TCP/IP, SSP, or GUI capabilities of the unit, depending upon what's checked. For example, if you wish to access the GUI via Xterm over a network you'd enable GUI and TCP/IP. If you wish to access the command line via telnet over the network you'd enable Command Line and TCP/IP. If you want to permit automatic data collection from XConnect you'd need to enable SSP and perhaps TCP/IP.

If you wish to place the 9210 on a public network such as the internet, it's recommended that additional security be utilized such as an external VPN Firewall (virtual private network) that would provide encrypted and secure communications.

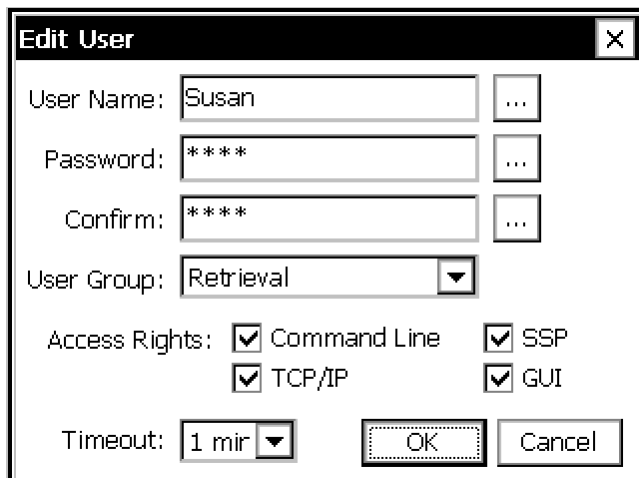

## SENSORS TAB

---

The Sensors tab shows all the sensors that have been added to the system, the sensor addresses, the last data value sampled from each sensor, and the quality of these last sampled values. The page is automatically refreshed every 5 seconds. Note that just because a sensor has been physically attached to the system does not mean the system software is aware it is there. Adding a new sensor or other input to the system is done through the *Setup* tab.

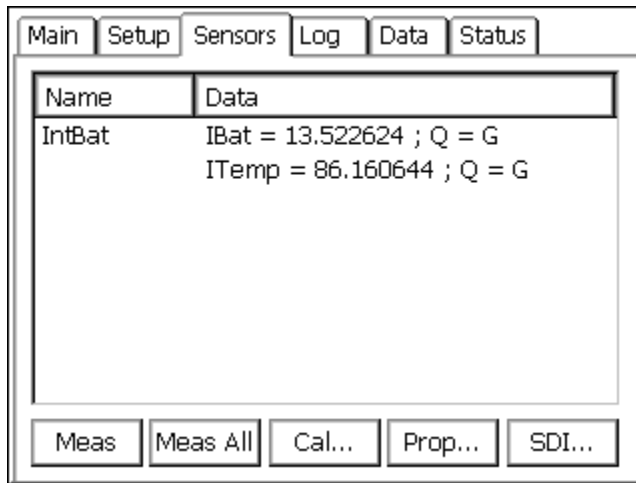

### Live Measurements

To get a live reading from any of the sensors, first select that sensor in the Sensors window and then press the *Meas* button. To get a live reading from all the sensors, press *Meas All*. Regularly scheduled sampling always gets priority over live readings, which might result in a live reading taking several seconds to be returned.

Note: If recording is not on, then attached I/O modules have not necessarily been initialized. As such, measurements may not be accurate.

### Calibration Sequences

The Calibrate button runs a calibration sequence on the selected sensor if one had been previously setup. The calibration procedure writes a message to the log to document any change that is made. [See SETUP BLOCKS/*sensor* descriptions to determine if a calibration method exists]

### Properties

The *Prop...* button brings up the properties page for the selected sensor. This allows sensor values to be changed without having to go to *Setup* (note, however, settings cannot be changed without turning recording off).

## Sending SDI-12 Commands

The *SDI...* button brings up a window that can be used to send commands and view responses from any SDI-12 sensor attached to the system, as shown below. Note that sampling from all sensors will be stopped while in this window.

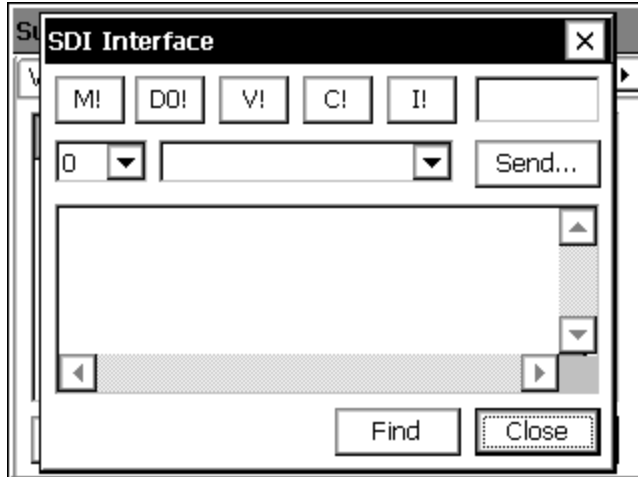

The SDI-12 window has a box for selecting the address of the device to communicate with and a *Send* button to create an SDI-12 message. There is also a drop-down menu with the last five commands to select, and send. The larger text box displays the history of the previous commands and replies from SDI-12 communication.

The SDI window has some shortcut buttons for sending the most common commands. These commands are M (measure), D0 (D (zero) - get data), I (information), V (verify) and C (concurrent measure).

A timer runs whenever a response is received on SDI-12. This timer is displayed to show the number of seconds that have elapsed since the last response. The user can use this timer to know when to issue D commands in the event that the SDI-12 device requires a long time to perform the measurement or function. The user may also monitor the text box for the sensor's service request prompt.

This window also has a *Find* button. Pressing it will cycle through all SDI addresses and display any connected sensors. A count of the number of sensors found will be displayed as the operation progresses. The find may take ten seconds to run, as there are over sixty SDI-12 addresses to check. When the unit finds a sensor, it will issue the I (identification) command and show the results of the I command in the command history text box.

When exiting the SDI window, the software will prompt to see if Recording should be restarted if it was stopped on entry.



## DATA TAB

---

The Data tab shows all the data values that have been tagged with either a Coms Tag or FieldVar setup block. If this window is empty, it means that neither Coms Tags nor FieldVar were used in the setup. The data in this window are the values that will be transmitted in response to a request for current data. If the data results from a Coms Tag that is connected to an Alarm block, the Alarm status will show up under the column labeled “Alarm”.

This window provides three controls: *Refresh*, *Measure* and *Change*. *Refresh* updates the window with the latest information. When the current selection is a Coms Tag, *Measure* causes the system to make a live reading of the sensor to which the Coms Tag is connected (see Note, below), and *Change* alters the current value for the value that is displayed. *Change* will also kickback the value to blocks to which it is connected, e.g., if a Coms Tag is connected to a Constant Block, change will alter the value of the constant. When the current selection is a FieldVar, *Measure* has no effect and *Change* changes the value of the displayed property.

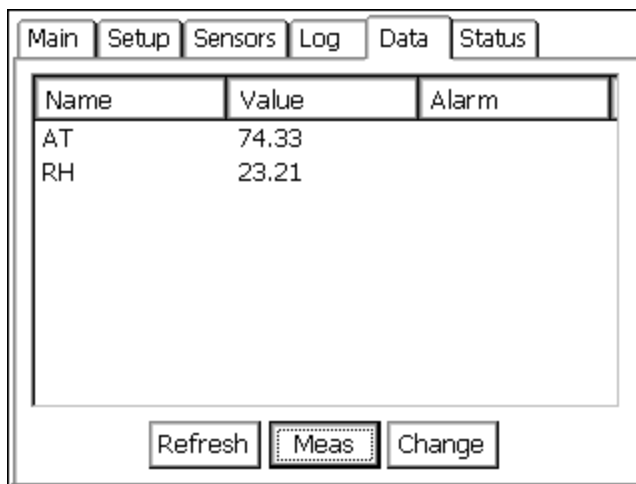

Note: Coms Tag blocks can only “measure” sensors with which they are inline, if there are no “active” blocks between the Coms Tag and sensor block. Generally speaking, this means the Coms Tag must be connected after the sensor block, and **before** any Measure, Average, or other active block (an “active” block is one that initiates a measurement, and typically has a darkened border in the graphical setup).

The FieldVar setup block, in conjunction with the Data tab, provides a way to access often-changed properties from multiple blocks in the setup in one convenient place. To understand FieldVar, some knowledge of the way the 9210 is set up is needed. The graphical setup is discussed in detail in the next chapter, but for the purposes of this discussion, let’s look at a sample setup screen:

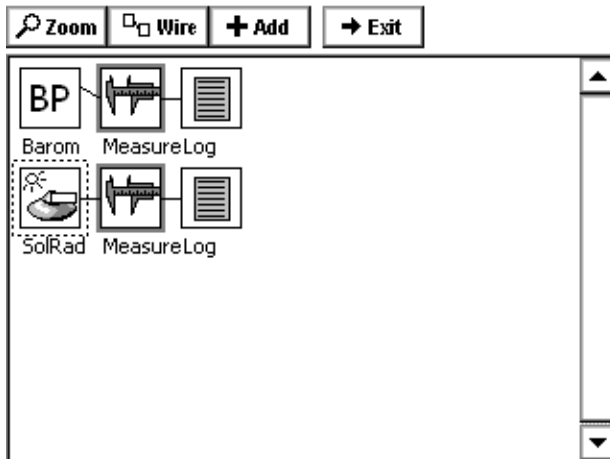

Each block represents something different. In the above setup, the solar radiation (SR) and barometric pressure (BP) blocks represent physical sensors, the measure blocks represents processing operations where the data is being regularly sampled, and the log blocks represent the files in which data is being stored. Data can be thought of as flowing from the left side of the screen to the right.

Each setup block has a properties window that is used to view or change its properties. Clicking an icon and then selecting Edit Properties from the menu that pops up bring up these windows. The properties window for the Measure blocks looks like this:

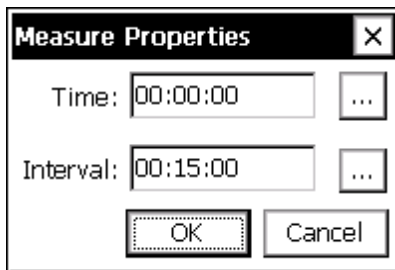

Note the  button next to the data fields, pressing this button will bring up another data entry box that will provide some data error checking that would not be available if data was entered directly into the field. It is recommended to always use the button before entering data.

Let's say we plan to change the sampling intervals for the SR and BP sensor often, and don't want to go into the setup each time we want to change them. This is a case where it makes sense to use the FieldVar block.

By using the Add button in the Graphical Setup screen, (described in the next chapter) we can attach a FieldVar block to each measure block:

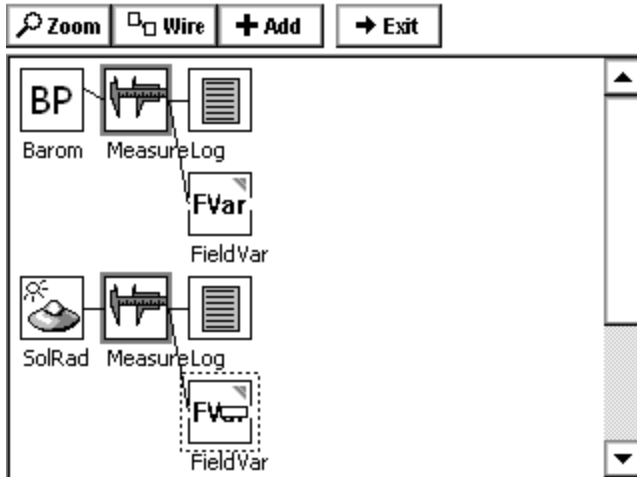

The properties window for either of these FieldVar blocks looks like this:

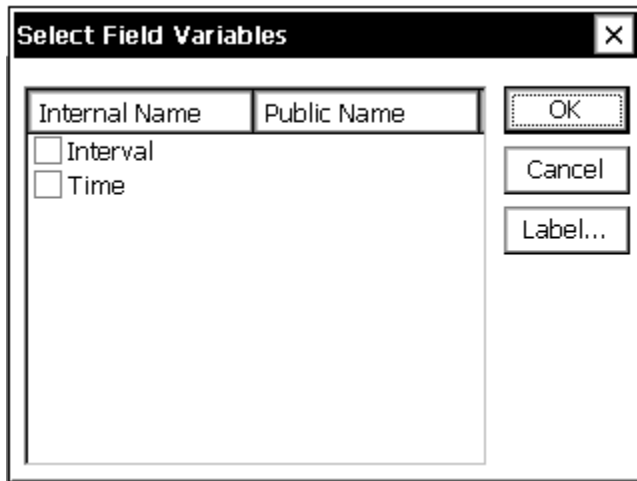

Listed are the two modifiable properties for the Measure block. To add *Interval* to our Data tab, check the box next to *Interval*. Then click on the word *Interval* to select it and click *Label*, to give this property a *Public Name*. For this example, assign the name “BP Interval”. The *Public Name* must be unique in the system in order to identify the referenced property. If no *Public Name* is specified, it defaults to *Internal Name* when OK is pressed, but will display an error if that name is not unique. To continue this example, click OK and then follow the same procedure with the other Measure block to assign its interval a *Public Name* of “SR Interval”.

Now when we exit the Setup screen and go back to the Data tab, we see the two interval properties for our measure blocks as shown below:

| Main                | Setup    | Sensors | Log | Data | Status |
|---------------------|----------|---------|-----|------|--------|
| Name                | Value    | Alarm   |     |      |        |
| BP INTERVAL         | 00:15:00 |         |     |      |        |
| SR INTERVAL         | 00:15:00 |         |     |      |        |
| Refresh Meas Change |          |         |     |      |        |

To change either property, simply select the one to modify and click *Change...* to enter a new value.

## LOG TAB

The Log window is used to display data from a log file and to export the file onto a PC. Support for logging to many different log files, or one log file for all data is built into the software. A log file can be viewed even if it is open and being logged to.

The Log tab is meant mainly to allow viewing of small sections of the log in order to validate sampling or to view recent values. To view large sections of the log or to perform data analysis, the log file should be retrieved from the unit. This is done using the *Export* button.

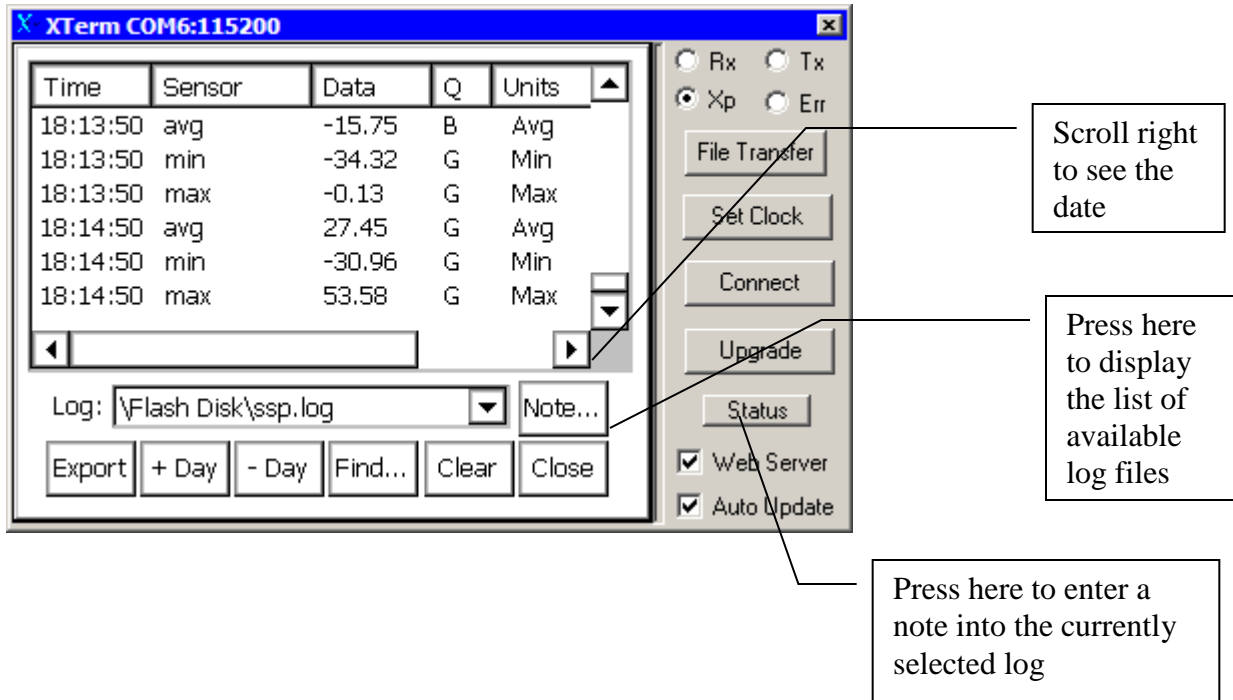

## Column Labels

### Time

This is the timestamp for the data in the log. This time is normally the time when the data was measured. In the case of an average, the time will be the time of the last measurement. In other cases, the time will be the time the computation was completed.

### Sensor

This is the user assigned name of the sensor, if each sensor is logged onto its own line. If EzSetup measurements have been assigned a LogID, this is where the LogID is stored. These should have unique names so that a charting or analysis programs can treat the values differently.

### Data

This is the value of the data point(s). The value is shown with a user-defined number of digits to the right of the decimal point. The user can set this precision in the properties window of each log block in the *Setup*.

## Q

This is an indication of the quality of the data. It is set to G (good) or B (bad) by the input module making the measurement. Other modules processing the data can also modify this quality. This field is not used when the LogID option is used, since one line can contain many sensors.

## Units

These are the units for the measurement. The units are generally set by the Sensor block (in the Setup Diagram), but can sometimes be determined by a Processing block. This field is not used when the LogID option is used, since one line can contain many sensors.

## Date

This is the date for the timestamp. It is displayed in the format selected by Set Date/Time in the Main tab. Because of the small screen size, the column for the date is hidden. Use the scroll bar to see the date.

## Selecting a Log File

Use the pull down menu next to *Select Log* to show all the log files in the system. Log files are created, modified and deleted under the *Setup* tab. To change what sensor data is placed into a certain log, the properties for that log block must be modified in the Graphical *Setup* screen. EzSetup Measurements are always placed into the SSP.log

## Navigating the Log

The log file can be navigated either with the scroll bars on the sides of the Log tab or with the buttons at the bottom of the display.

### +Day, -Day

The buttons *+Day* and *-Day* can be used to jump ahead or back one day's worth of data.

### Find...

The *Find...* button can be used to search for the data logged near a certain date and time.

## Clearing the Log

Pressing this button causes contents of the log file to be erased. The system will ask for confirmation before doing this. Note that this erases the contents of the log file but does not delete the log file – this can only be done under the *Setup* tab. Data will continue to be stored to a cleared log file if logging to that file is active as defined in the in the *Setup*.

## Entering a NOTE

To enter a note into the log, first select the log where the note should be placed (typically the system log, as most users don't want notes in their data logs), press the "NOTE" button and enter the text to be added. Then press OK in the upper right corner to enter the note, or press X to

cancel entering a note. This is a useful way to document site visits, or to note any issues found while on a site visit.

## Export

This button is used to retrieve the log file, clicking it will lead through the steps to create an ASCII file of the log. The log file is a compressed file. If FILE TRANSFER were used on the log file, and the file is viewed with a test editor, gibberish is seen because of the compression. Converting the file to ASCII allows the contents of the file to be viewed.

As a part of this Export process, the system will ask to specify a destination for the file. If a prompt to save the file on the PC doesn't appear, change the directory for the file to be \Temp. To do this, press the button labeled *up* and then select *Temp*. If \flash disk\ were selected as the destination directory, the flash disk could be filled with the new file and shut down the system.

If the 9210 contains a storage card (USB or SD), then when the button labeled *UP* is pressed, you will be able to select one of "\USB Card" or "\SD Card" as a destination.

Press the Export button to see the following dialog:

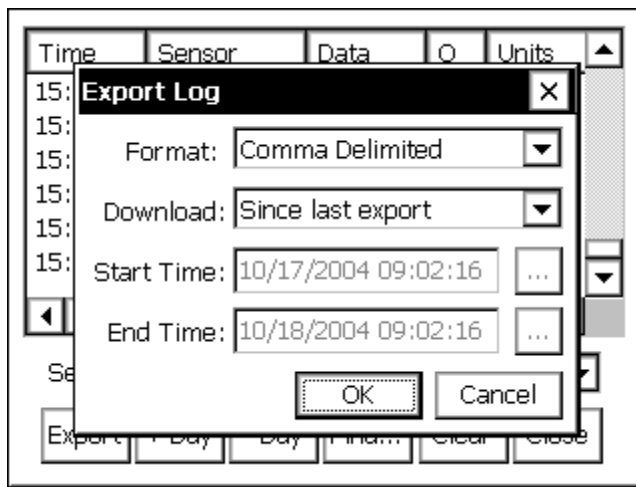

This dialog will define what the exported log file should look like.

The *Format* options are: Comma delimited, Tab delimited and Fixed Column. The comma delimited format works well with spreadsheets. The Tab Delimited and Fixed Column formats can work well when printing.

The *Download* options are defined as follows:

- Since last export - When this option is selected, the system exports only data that is more than the time of the last log export. If the log has never been exported, the system exports the entire log.
- Start time to end time - When this option is selected, the system exports only the data that has a timestamp between the dates and times specified in *Start Time* and *End Time*.
- Start time to end log - When this option is selected, the system exports only the data that has a timestamp between the times specified in *Start Time*

and the end of the log.

- Start log to end time - When this option is selected, the system exports only the data that has a timestamp between the start of the log and the time specified in *End Time*.



## STATUS TAB

---

The status tab displays detailed status information. The data displayed includes the status on each I2C module, any communication modules and the system in general. To update the status menu, press the *Refresh* button.

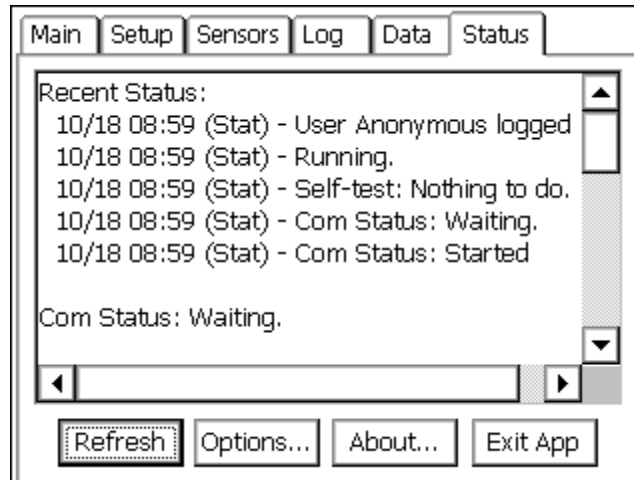

Select the *Options* button to access status reporting options. The Status Options allows the user to configure where status and debug messages should be sent. Note that status messages are automatically stored in the system log.

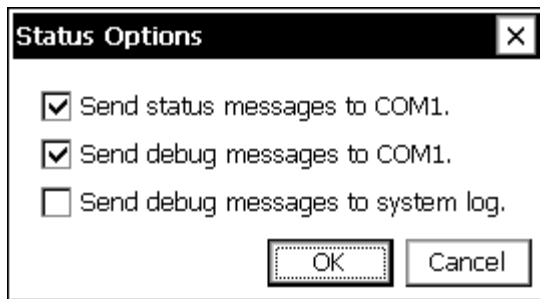

Press the *About* button to access version information, copyright information and the unit serial number.

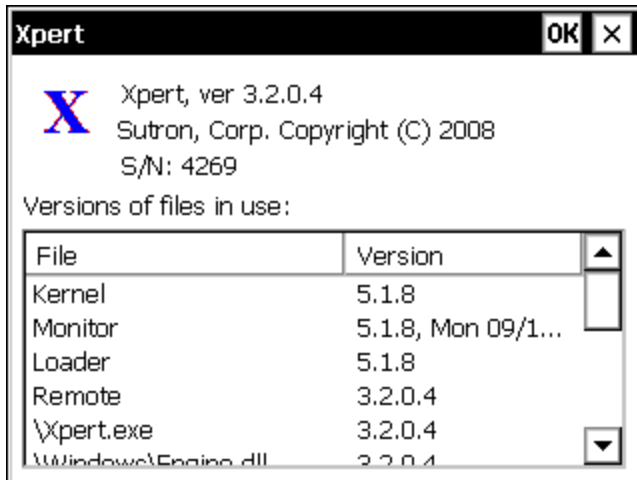

The *Exit App* button is used to stop the 9210 program. Normally this is only done to update the program itself. When the 9210 program is stopped no data collection or recording will take place. The software warns with the message “Warning, this will terminate the 9210 program. All data and setup not in flash will be lost. Are you sure?”

## OPERATING THE DISPLAY

---

The display provides a simple way of viewing the status and data and it allows for some simple calibration of sensors. However, the display cannot be used to configure the unit or to do complicated troubleshooting or maintenance.

The display is very easy to operate. To turn the display on, simply press any of the keys (LEFT, SELECT or RIGHT). The display will immediately turn on and display the system status followed by the data from selected items in the setup. After displaying the values, the system prompts:

```
Exit Xlite (*)
(<>=Choose options)
```

The \* is a reference to the SELECT button, < is LEFT and > is RIGHT. In general pressing SELECT (\*) selects the item being displayed. Pressing < or > either moves the system to the previous or next value or character. While a prompt for \*, <, or > may not be on the display, the operation of the buttons is intuitive and easy to use.

With the above prompt, pressing SELECT will cause the display to exit and turn off. Pressing < or > will cycle through the other menu choices:

```
Display Status (*)
Display Values (*)
Calibrate (*)
Setup (*)
View Log Data (*)
Dump Log Data (*)
SDI (*)
Coms Test (*)
Edit Basic (*)
Edit Satlink (*)
Exit Xlite (*)
```

Each of the menu choices is described in the following sections. Note that other menu choices may appear when certain custom Sutron Link Libraries (SLLs) have been added to the Flash Disk. See the manual for the custom SLL for a description its menu entries.

If no key is pressed within a few minutes, the display turns off automatically regardless of what the user was doing at the time. Any work being done by the user when this happens is lost.

### Display Status

This function displays the station name, date, time, and recording status. If the status is “Running”, the system is recording and operating normally. If the status is “Stopped”, the system is not recording and must be restarted (using either Xterm or cycle power to the unit).

After displaying recording status, the system status page is displayed. This page is the same data the is seen on the GUI interface’s Status Tab. Press the “<” and “>” keys to scroll through the status data. Press the “\*” key to exit the status page.

## Display Values

This function displays the last value processed for selected items in the setup. The Display Block that can be added to the setup identifies which data to show. The display appears similar to the one below:

```
Stage (* Meas)
12.34 FT G
```

In this example, the name of the value is Stage. The value is 12.34. The units are FT and the quality is G. The name and precision (number of digits after the decimal point) are both defined by the display block. The value, units and quality all come from the item the sensor block is connected to in the setup. The quality can be G=GOOD, B=BAD or U=UNDEFINED. Quality status of UNDEFINED generally means that the system has not tried to measure the sensor yet.

The (\* Meas) is a hint to press the SELECT button to force a measurement or update the value. This is useful to know what a sensor or value is reading right now.

## Calibrate

Calibrate will run a sensor specific calibration routines for sensors. These routines set the current value for a sensor, enter an offset or follow a specific calibration procedure. When Calibrate is selected, the system looks for any setup blocks that have a calibration procedure (note: in Graphical Setup, Display blocks must be connected directly to sensor blocks in order for the calibration routines to be detected). The system builds a list of these procedures and then displays the name of the first with the prompt, "press \* to Cal". Pressing SELECT will start the calibration procedure; pressing < and > will select other calibration procedures.

Calibration generally involves entering a value into the 9210. To do this, use the <, \* and > keys to enter a value. As an example, to calibrate a shaft encoder, the system will prompt:

```
+000012.34
Edit Cur.Lvl
```

An underline cursor will be under the +. To change the value, use the > or < keys to move the cursor to the digit to change. Press \* (SELECT) and the cursor will change to a block. Then use the > and < keys to change the digit. When finished changing the digit, press \* again. The cursor will automatically go to the next digit. Repeat the process to change other digits. Note sign can be changed, but not the decimal point. After the value is correct, move the cursor past the end of the number. The system will then prompt:

```
Cur.Lvl +000010.85
<OK> <CANCEL>
```

Notice that the flashing cursor will be in the OK. Use the < or > to change the cursor to select either OK or CANCEL and press \* (SELECT).

To exit the calibration routines, use the < and > keys to select:

```
Exit Cal
(*=Exit)
```

and press \* (SELECT).

The tipping bucket calibration includes the ability to test or set the tipping bucket. Please see the Tipping Bucket section of this manual (page **193**) for more information.

## Setup

This submenu offers the ability to make simple changes to the setup. The submenu has the following items:

- Start/Stop Recording
- Load SSF from Card
- Save SSF to Card
- Change Station Name
- Change Sensors
- Set Time
- Exit Setup

### Start/Stop Recording

If the system is currently recording, this menu item will say “Stop Recording”, and selecting the item will cause the system to stop recording. Conversely, if the system is currently not recording, this menu item will say “Start Recording”, and selecting the item will cause the system to start recording.

### Load SSF From Card

A setup from a storage card can be loaded into the 9210 using this menu. Press \* to select the item, and the software will prompt “Insert Storage Card” if one is not present. The software will then search the storage card for setup files and display a prompt to load the first file it finds. Use the arrow keys to select <OK> or <CANCEL> as desired and press \*. If <OK> is selected, the new setup will be loaded. This will change everything in the station setup except for the station name and user accounts. The system will prompt “Make Setup Default”. Select this choice to have the setup renamed to be station\_name.ssf or default.ssf so it is automatically used on startup. If <CANCEL> is selected, the file will be copied with its original name unchanged. After copying the setup, the system will load it and then start recording automatically.

### Save SSF to Card

Selecting this menu item will cause the system to save the current setup to a storage card. The system will prompt for the storage card to use (USB or SD), or will prompt to insert a storage card if one is not already present.

### Change Station Name

Selecting this menu item allows you to change the station name. The system warns you if you change the station name to something that does not correspond to a setup file currently on the flash disk (which would result in no setup being loaded on a system reboot).

### Change Sensors

Selecting this menu item brings up a submenu that allows you to change the label, units, slope, and offset of displayed sensor values. A sensor value appears in this list when it has a display

block connected to it. The slope and offset properties can be changed only when the sensor to which the display block is connected contains such properties.

### **Set Time**

Selecting this menu item will prompt you to enter a new system time.

### **Exit Setup**

Selecting this menu item will exit the Setup sub-menu.

### **View Log Data**

View Log Data will view the data in any of the logs. When selected, the system will display the name of one of the log files. Pressing < and > will allow you to select any of the available log files. Then, simply press \* to select the file. The system will display the most recent data in the selected log. Press < to view older data and press > to see newer data. When finished viewing the log data, press \* to exit.

### **Dump Log Data**

Dump Log Data will copy the data from the logs to a storage card. When Dump Log Data is selected, the system will prompt to insert a card if one is not already installed. The system will then display the name of one of the log files with <OK> <Cancel>. Press \* to dump the named file or use an arrow to select cancel and then press \*. The system will prompt to select the desired output format for the file. Press \* to select the format that is listed or use the arrow keys to select cancel and press \*.

After dumping one file, the software will repeat the above process until all the log files have been processed.

### **SDI**

This submenu offers the ability to send SDI commands to connected SDI devices. The submenu has the following items:

- Send Command
- Find Sensors
- Show Found Sensors
- Exit SDI

### **Send Command**

Selecting this item prompts you to enter an SDI command to send. After the command has been entered, the command is sent and the result of the command is displayed. If the sensor responds, the result from the sensor is shown, otherwise an error message is displayed.

### **Find Sensors**

Selecting this item causes the system to search for connected sensors by querying each address for a sensor. Once all addresses are queried, a list of address found is displayed.

## Show Found Sensors

Selecting this item will display the list of sensor addresses that were found during the last Find Sensors operation.

## Coms Test

This submenu offers the ability to view the status of and test SSP communication ports. A port can be tested only if you have first set up the port in the Coms (SSP/CL) entry on the Setup tab. You will first be prompted to select a port to test (“COM1: to COM9:”), and then you will be presented with a submenu with the following items:

- Show SSP Stats
- Clear Stats
- Check Mail
- Send Mail
- Key
- UnKey
- Exit Coms Test

## Show SSP Stats

This option will flash receive and transmit message counts on the screen for 5 seconds:

RX: 100/102,1

TX: 100/100,0

The 3 RX counts are as follows:

- Rx Good      The number of SSP messages received that were address to this station. The SSP station ID is the same as the Station Name defined on the Main page.
- Rx Total      Total number of messages received including ones not addressed to the station.
- Rx Bad        Bad messages. May indicate that the message itself wasn't assembled correctly, as TCP/IP messages are error corrected and CRC errors should not occur at the SSP level.

The 3 TX counts are as follows:

- Tx Good      Number of messages sent that appeared to go thru.
- Tx Total      Number of messages attempted.
- Tx Bad        Number of transmissions that failed

## Clear SSP Stats

This option will clear the RX and TX counts.

## Check Mail

This option will display any SSP test messages received on the port.

## Send Mail

This option is used to send an SSP test message. You will be prompted for the Destination, the Mail Message to send, and the “# Bytes to Send”. To stress the connection you may send very long messages by increasing the “# Bytes to Send”, and the message you entered will be repeated as many times as needed to achieve the desired number of bytes. The Destination will default to (“\*”) which will cause any station listening to receive and acknowledge the message, but a specific station name may be entered. When the operations has completed, either the message “Mail Delivered.” or “Mail Failed.” will be flashed on the screen for 2 seconds. A “Mail Delivered” message is proof that 2-way communications occurred.

## Key

This option will assert DTR and RTS on the communication port. This is used to cause a LOS Radio to “key” or turn on and send a pure carrier signal, at which point transmission power, and receive power tests can be conducted.

## UnKey

This option will de-assert DTS and RTS on the communication port. This is used to cause an LOS Radio to “unkey” and stop transmitting.

## Edit Basic

The Edit Basic menu item allows the user to load and save program files to and from a storage card, as well as to delete basic program files from the Flash Disk.

## Edit Satlink

The Edit Satlink menu item allows the user to change the Satlink satellite id and self-timed transmit time (in minutes), as well as to send a test transmission.

When Sat ID is selected, the system will prompt the user to enter the eight (8) character satellite id that consists of the characters 1 - 9 and A - F. After scrolling to the end of the id entry, the system prompts to save the entry. Move the cursor to <OK> and press select to save the entry, or move the cursor to <CANCEL> and press select to cancel the changes. Note: If the selected self-timed format is INSAT in the system setup, then a second satellite id may also be changed.

When Tx Time is selected, the system will prompt the user to enter the number of minutes for the desired transmit time. For example, if a transmit time of 04:00:00 were desired, you would enter the number of minutes in 4 hours, or 240. After scrolling to the end of the entry, the system prompts to save. Move the cursor to <OK> and press select to save the entry, or move the cursor to <CANCEL> and press select to cancel the changes.

When Test Tx is selected, the system will prompt “Are you sure?”. This is done because sending a test transmission sends the default test transmission string (the alphabet) which could interfere with other transmissions if a dummy load is not connected. Move the cursor to <OK> and press select to continue with the transmission, or move the cursor to <CANCEL> and press select to cancel.



## USING STORAGE CARDS

---

Each 9210 can support USB or SD storage cards. These storage cards can be used to either expand flash disk space for data logs, to upload/download setups, or to download log files. Custom applications may add other functionality.

NOTE: Storage Cards must be formatted using FAT16 or FAT32, not NTFS.

Working with a storage card is similar to working with the internal \flash disk\ folder. Whenever specifying the location to place files, press the UP button (see below) to see a root directory structure. The storage card will be shown as “USB Card” and “SD Card” folders. Double click the folder to select it.

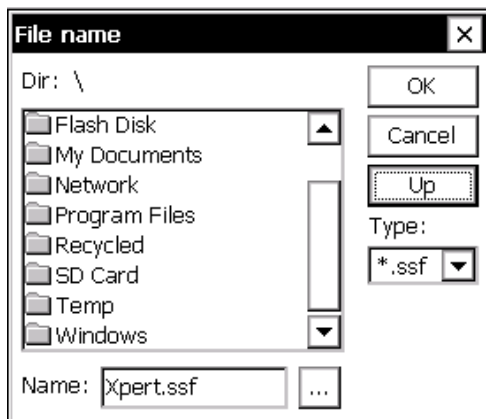

### Expand log file capabilities

A storage card can be used to increase the amount of log file flash disk space from the built in 32MB (shared) to the size of the storage card.

To do this, follow these steps:

4. Place the card into the appropriate slot
5. Go to the Setup tab
6. Click LOG, then EDIT
7. Click the NEW button
8. Click the ... button next to filename
9. Click the UP button, and then double click into the storage card's folder
10. Enter a file name for the log
11. Click the OK button back to the LOG FILE PROPERTIES box
12. Don't forget to increase the size of the log file!
13. Click OK and the log file will be created on the storage card

To use the log on the storage card, select the log file on the storage card folder from the LOG block properties.

Note: the minimum log size is 2048 bytes. The maximum log size is the lesser of 1) 2 billion bytes, or 2) the free space available on the storage medium minus a small safety buffer (32k for storage cards, 192k for Flash Disk).

## Upload/download setups

Setup files can be stored on storage cards, just as they are stored on the local flash disk. To do this, follow these steps:

To save the setup from the GUI (Xterm):

14. Place the card into the storage card slot
15. Go to the Setup tab
16. Highlight the Setup File entry and press the Save As button
17. On the right side of the File Name dialog, press the Up button
18. Double click the name of the storage card folder (USB Card, SD Card)
19. Give the setup a name, or leave it at the default, then click ok.

To open a setup from the GUI (Xterm):

20. Place the card into the storage card slot
21. Go to the Setup tab
22. Expand the Setup File entry, select Open or Append, and press the Edit button
23. On the right side of the File Name dialog, press the Up button
24. Double click the name of the storage card folder (USB Card, SD Card)
25. Click on the setup name to open or append, and click ok

To open a setup using the front panel display:

26. Place the card into the storage card slot
27. Go to the CHANGE SETUP menu, press middle button (\*)
28. Press \* again with cursor flashing on <OK> to load a setup
29. The Xlite then scrolls through each setup available on the storage card, if the first one is the setup to load, press \* with cursor flashing on <OK>. If the setup is not the one desired, press right button to move cursor to <CANCEL>, then press \*. Continue this until the desired setup is found, then press \* with cursor on <OK> to load that setup.

## Download log files

Log files can be retrieved from a unit onto a storage card. To do this, follow these steps:

To retrieve the log using the GUI (Xterm):

30. Install the card into the storage card slot
31. Go into the LOG tab
32. Click export, choose a data format, then click OK
33. Click the UP button, and then double click into the corresponding storage card folder (USB Card, SD Card)
34. Give the file a name, or use the default,
35. Select the download format, then click OK

To retrieve the log using the front panel:

36. Install the card into the storage card slot. Later versions of 9210 software ( $\geq 3.1$ ) will prompt to download each log found in the system (note: it takes several seconds for this prompt to appear). Otherwise, ...
37. Go to the DUMP DATA menu, press middle button (\*)

38. Press \* again with cursor flashing on <OK> to select the desired storage card
39. The Xlite then scrolls through each log file available on the Xlite, if the first one is the log file to download, press \* with cursor flashing on <OK>. If the setup is not the one desired, press the right button to move cursor to <CANCEL>, then press \*. Continue this until the desired log file is found, then press \* with cursor on <OK> to download that log.
40. The Xlite will then ask for a download format. If the first one (comma separated values) is desired, press \*, otherwise press right button to move the cursor to cancel, then press \*. Repeat this until the desired format is found and then press \* with cursor over <OK>



# **Chapter 4: Graphical Setup Diagrams**

## OVERVIEW

---

This chapter will discuss the way in which to create and modify graphical setup blocks. Determining when to use the graphical setup versus the Ezsetup measurements is discussed in detail in chapter three, but the simple rule is this: If the sensor is measured, or averaged only, then use EzSetup Measurements, if additional processing is needed, or the data is needed for calculating other parameters, use the graphical setup.

The graphical setup blocks screen is accessed by going into the Setup tab and clicking on either the Graphical Setup tree and clicking *EDIT*, or by selecting one of the graphical sensors under the Graphical Setup tree and clicking *EDIT*. Selecting Graphical Setup and clicking *EDIT* will show all sensors configured in a graphical manor, selecting only one of the graphically setup sensors will show that sensor and all processing related to that sensor only. Some users find that viewing the whole Graphical setup can be overwhelming, therefore it is recommended to only select/create one sensor at a time when setting the system up.

## AN EXAMPLE GRAPHICAL SETUP

---

Pressing *Edit* with the *Graphical Setup* item highlighted on the *Setup* tab brings up a screen similar to the one shown below. The tabs at the top of the screen have been replaced with the buttons *Zoom*, *Wire*, *Add*, and *Exit*, with the rest of the screen reserved for placing and connecting setup blocks. From this screen, we can get a quick view of where data is coming from, how it is being sampled and processed, and where it is going. Below, for example, we see:

A parameter from the barometric pressure sensor is being periodically sampled and its maximum or minimum being stored to a log at some rate; and,

Solar radiation is being regularly sampled, logged and periodically transmitted via satellite to a main station.

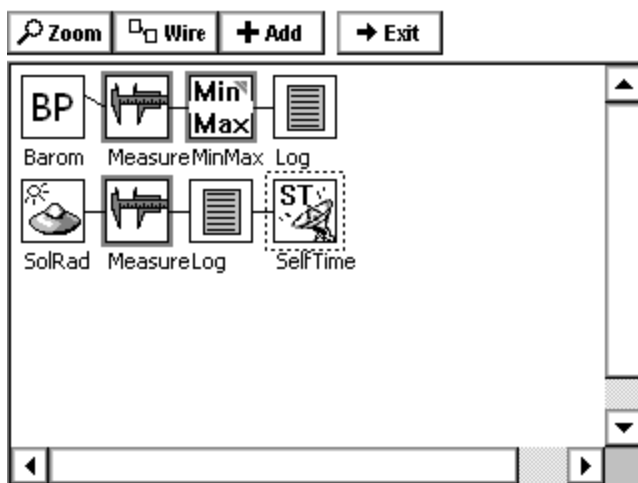

### Block Categories

Setup blocks come in general categories – *Input*, *Processing*, *Logging*, *Telemetry*, *Miscellaneous* and *Output*. Four of these types of block are represented above. On the left are the *input blocks* representing barometric pressure and solar radiation sensors hooked to the system. Next to them are the *Measure* and *MinMax processing blocks* which request and/or perform operations on the data from the sensor blocks. Note how these two blocks have darkened borders. This is an indication that the block is “active”, i.e., that it initiates data flow through a chain of blocks.

After the *Measure* and *MinMax*, blocks come two *log blocks*, which indicate where the data is being stored. Finally, there is a *telemetry block* that indicates how the data is being transmitted.

Blocks of a certain type are not restricted to a particular column in the display, but data does always flow from the left side of the screen to the right.

### Block Inputs and Outputs

Setup blocks are hooked together via their inputs and outputs. A block with an input can *accept* data from another block and a block with an output can *send* data to another block. To see this more clearly, we’ll zoom in on our example using the *Zoom* button on the top of the screen:

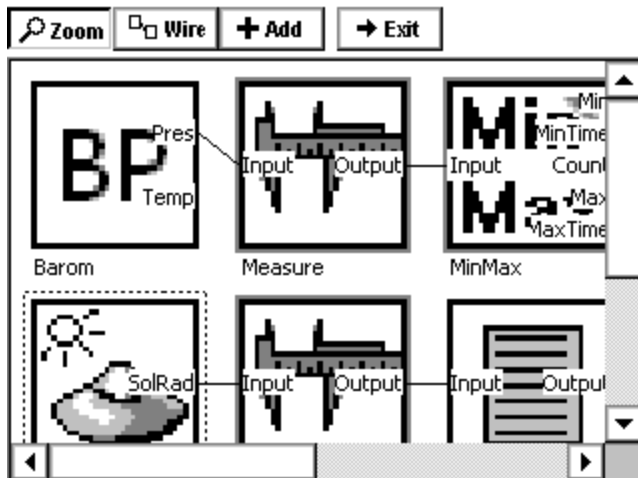

We can now clearly see the inputs and outputs each block has available along with which are being used and which aren't. It is now evident, for example, that only the *pressure* from the BP block is being sampled (not the temperature) and that only the *maximum* value of this pressure is being logged.

## Block Connectability

The graphical setup allows any two blocks to be connected together as long as the first has an output and the second an input. However, this does not necessarily mean that any constructed setup will work. For example, even though the system will allow a sensor block to be hooked directly to a log block, no data will necessarily be logged, unless there is an “active” block to control when processing takes place ( “active” blocks are those with darkened borders; see the example in the next section).

## Active Blocks and Push/Pull

"Active blocks" are blocks that make the other blocks connected to them execute (or perform their function). This results in data being pushed and pulled from and into the other blocks. Active blocks always have a darker, thicker border, so they are easier to recognize.

Active blocks typically ignore the call to execute and push/pulls from other active blocks. This helps to ensure the system is as determinant as it can be (i.e., this helps to ensure you can figure out who's going to execute, and when).

In the example below, the first Measure block signals the Const block to execute, and then pushes the result into the second Measure block and the lower Log block, L2. The data is logged to L2, but since Measure blocks are active and thus ignore pushes and pulls, the data is not logged to L3.

When the second Measure block executes, it signals the first Measure block to execute, and then pushes the result to L3. When the Measure block is signaled, he simply returns the last known value for Const, instead of measuring anew, again since active blocks ignore push/pull requests.



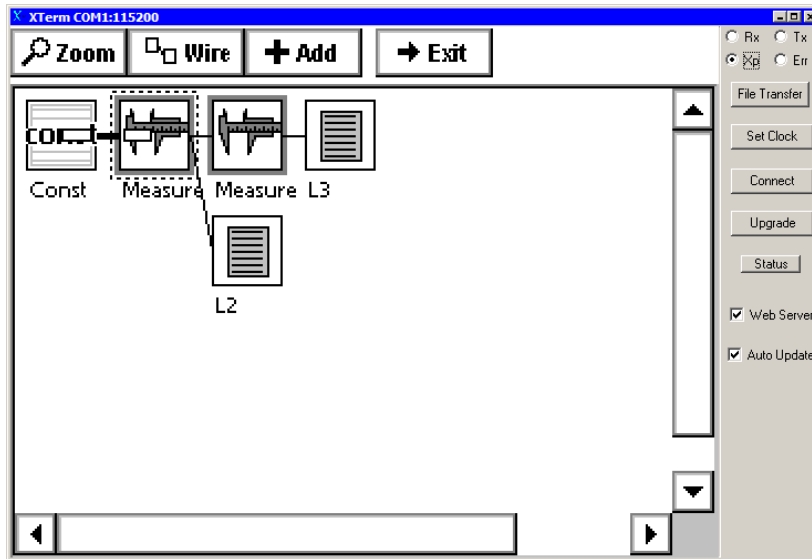

## Block Placement

Some setup blocks require specific placements to work properly. Here are some examples:

**ComsTag block:** in order for a ComsTag block to be able to retrieve a new (“live”) value from an input sensor, the ComsTag block must be placed after the sensor block, but before any active blocks

**Display block:** In order for the Display block to enable front panel calibration for a sensor block, the Display block must be connected directly to the sensor block.

**Any passive (non-active) block with more than 1 input (e.g., XYFunc and Bool blocks):** in order to ensure this kind of block operates on data measured in the same frame, and to avoid certain side effects that come from active blocks executing along split paths that rejoin (like logging twice), place the measure block **AFTER** the block having the multiple inputs.

See Appendix A for constraints of other blocks.

## Block Properties

We now know a lot about what is happening with our example setup, but not everything. We don’t yet know, for example, the units the barometric pressure setup is going to return its data in, or how often the solar radiation is going to be sampled, or what log file either sensor will be saved in. For this information, we need to look at block properties.

To view the property window for a block, click the icon for the block once and then select *Edit Properties* from the menu that appears:

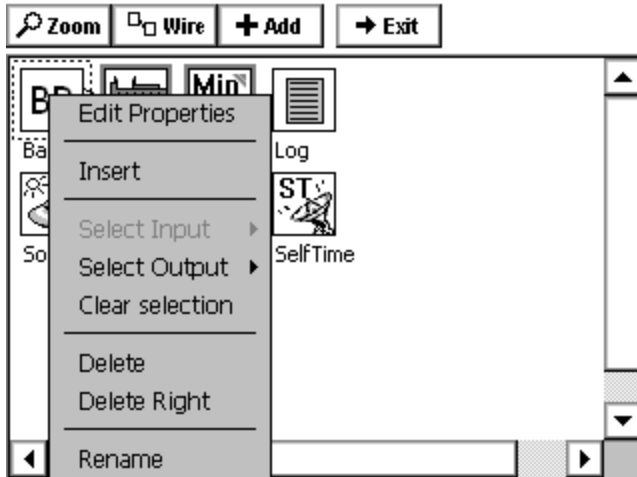

If we do this for the BP sensor block, the following block properties window comes up, revealing the pressure units to be sampled, the SDI address, the averaging time and the temperature options:

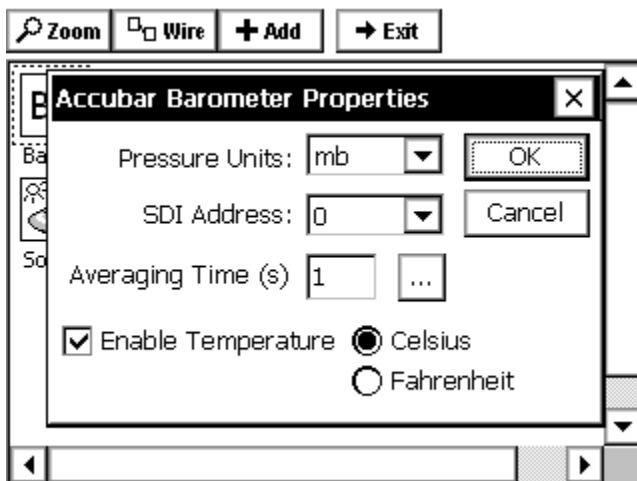

Viewing the property windows for the other blocks in the setup can be viewed in a similar manner. A full description of the properties for each block can be found in Appendix A: Setup Blocks.

## CREATING A NEW GRAPHICAL SETUP

---

Now that we have seen an example graphical setup, let's see what it takes to create a small one from scratch. From the Setup tab, highlight [New] and select *Edit*. This will bring up a blank setup screen:

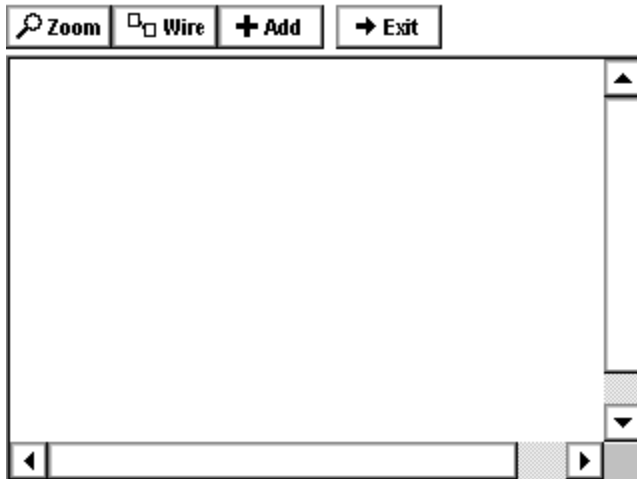

Let's say we've just physically hooked-up two sensors to our 9210 and want to add them to this new setup. One is an RM Young wind sensor, from which we want to log wind speed and wind direction and the other is a submersible pressure sensor, from which we want to measure water depth.

### Adding a Sensor Using the Wizard

Click the *Add* button to add the first sensor. The following screen will come up:

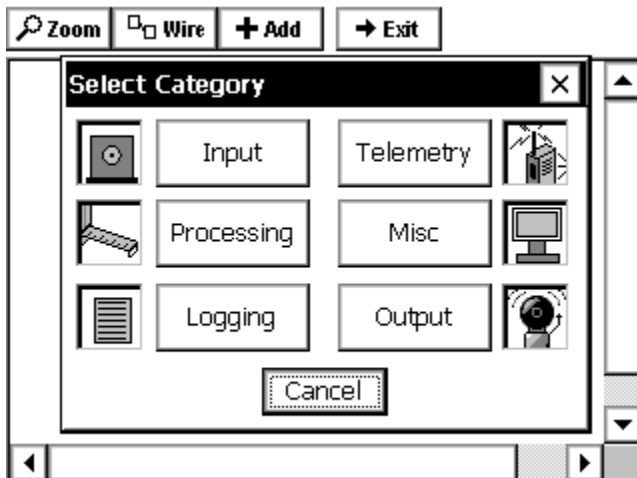

This screen shows the different types of setup blocks. Now click *Input* to bring up a list of the available input blocks:

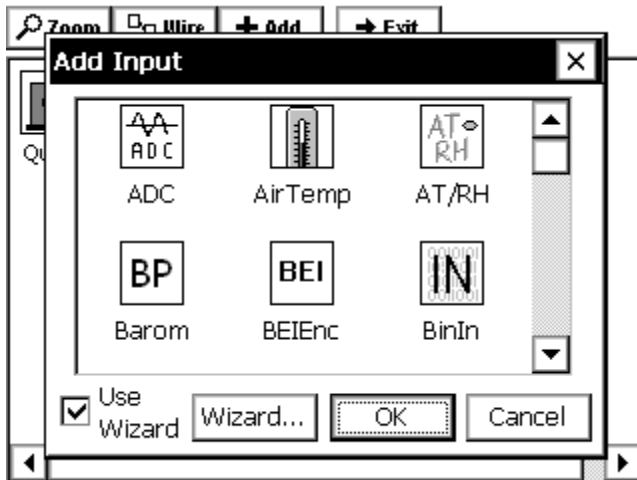

Scroll up or down to find the input block labeled RMYoung. For now, leave the checkbox next to *Use Wizard* checked and click *OK*. Now the main setup display will look like this:

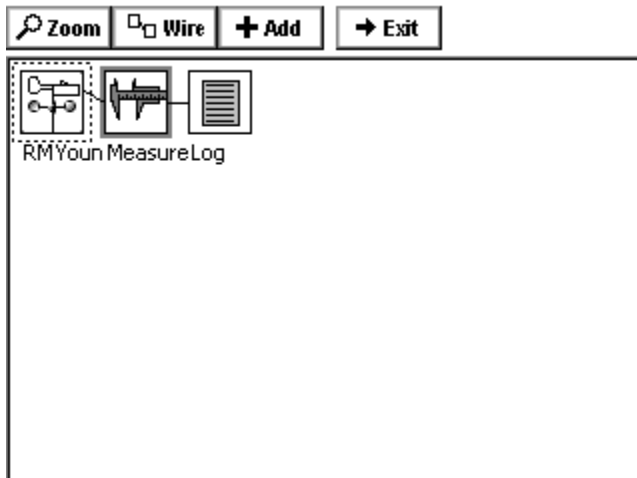

By using the Wizard, we can see that not only has the RMYoung sensor block has been added to the setup screen, but a measure block and log block as well, with connections! The exact blocks that are automatically added with the Wizard are customizable with the *Wizard...* button in the Add Input window above.

## Adding Additional Blocks

Looking carefully, we see that only one of the outputs from the RMYoung block will be sampled and logged with this arrangement. Zooming in on this block indicates it is the wind speed output:

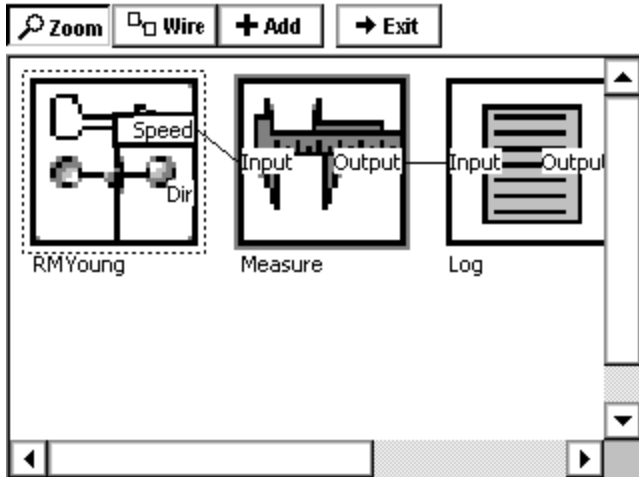

To also sample and log wind speed, we need to create another instance of the measurement and log blocks and connect them to the wind direction output of the RMYoung block. To do this, first: click the RMYoung icon, click *Select Output* and then (from the slide-out menu) click *Dir* for the direction output:

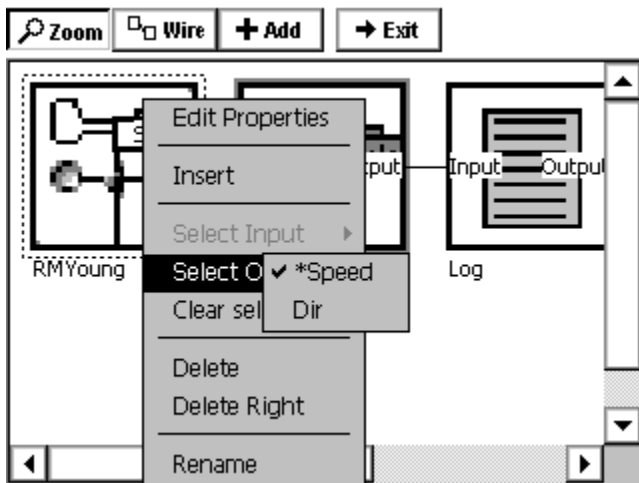

Now click the *Add* button at the top of the screen, click *Processing* to show the processing blocks, select the *Measure* block and click *OK*. Now we see another measure block has been placed under the first:

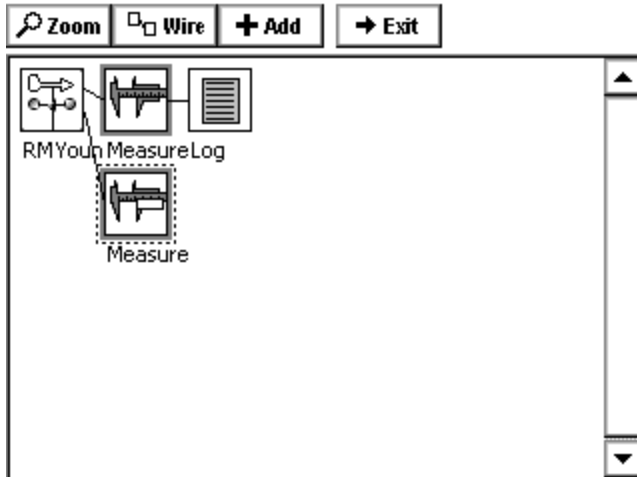

Although it seems as though we would now hook this measure block up the to the log block already placed in the setup, we actually now want to add another log block below the first. This is because a setup blocks input cannot accept a signal from more than one block. However, this results in no loss of functionality as the new log block can be configured to log to the same log file as the previous one.

So, to add this second log block, click the *Add* button, select *Logging* to bring up the logging blocks, select the *Log* block and then click *OK* (we didn't have to select the output from processing as it was already selected from above). Now both of the signals from RMYoung will be sampled and logged:

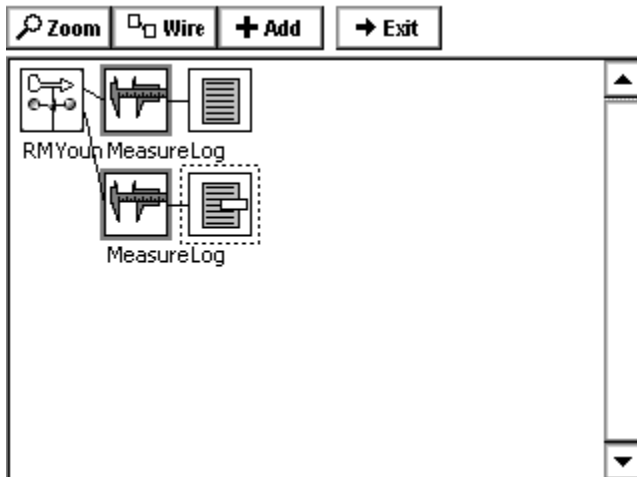

## Changing Block Properties

### Sensor Block Example

Now that all the setup blocks have been placed and the flow of data established, all that is left to do is to change the properties of each block as desired. Clicking the block and then clicking Edit Properties can bring up the properties window of a block. Doing this for the RMYoung sensor block brings up the following window:

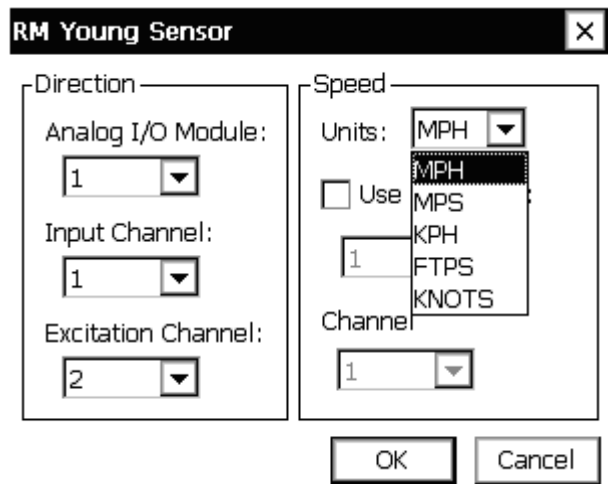

Detailed information on the different fields in this block can be found in Appendix A: Setup Blocks. For now, just change the units to from mph to Knots and click *OK*.

### Processing Block Example

Now click the top measure sensor block and select *Edit Properties*:

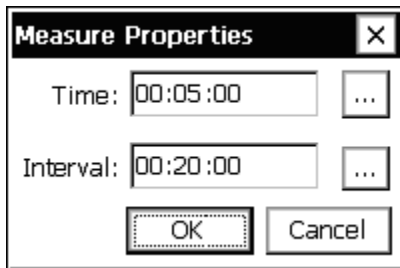

This is where we enter the start time offset and the sampling interval. The measure block is used when samples are desired at a fixed, regular interval. We set up this block to measure wind speed every twenty minutes with a five-minute offset from the top of the hour (e.g. at :05:00 :25:00, :45:00 every hour).

### Log Block Example

Finally, click the top the log block to view its properties:

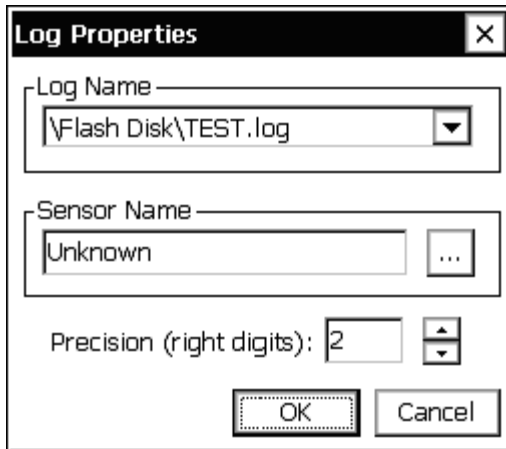

At the top of this properties window is a drop down menu with all the log files that have been created in the system (including an entry that, will create a new log). This drop down box identifies the log to which this setup block will store data.

The default *Sensor Name* can be changed to identify the source of data in the log (this name is used in the Log tab as well as in imported data files). Changing this label is especially important in cases where there is more than one of the same types of sensor.

The *Precision* indicates to what precision the data (wind speed, in our example) will be logged. The value specified should be less than or equal to the sensor's actual precision.

Changing the properties of the other measure block and log block in our setup for sampling and logging wind direction would be done similarly. Full descriptions of purposes and settings for each setup block can be found in Appendix A: Setup Blocks.

### Changing the Block Label

The label displayed underneath the block in the setup diagram can be changed by selecting *Rename* from the pop-up menu that appears after clicking the setup block. Use this to help identify specific blocks in the setup. In addition, this name appears in SETUP and Sensors.

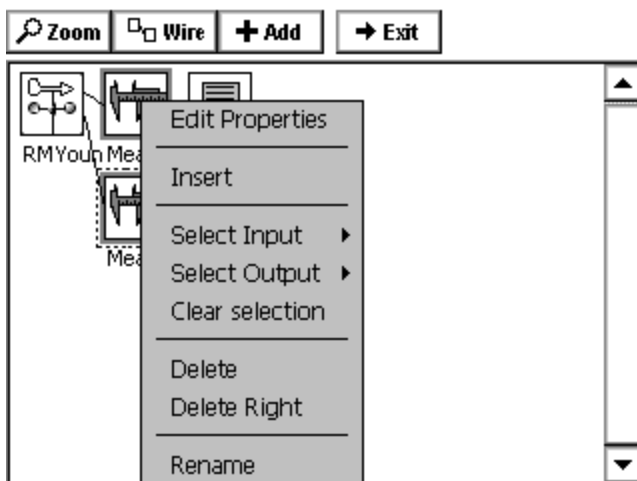



## MODIFYING A GRAPHICAL SETUP DIAGRAM

---

### Wiring and Unwiring

The 9210 will attempt to wire blocks together automatically whenever possible. For example, if the output of a Measure processing block is selected and then a log block added, the system would automatically wire them together. However, sometimes blocks need to be wired or unwired manually.

For a simple example of wiring and unwiring, let's say we want to change the setup we have built so far to: 1) add a solar radiation sensor block and 2) hook its output to the second log block instead of the RMYoung wind direction output.

First, we add a solar radiation sensor using the *Add* button (as explained in the previous section) *without* using the Wizard:

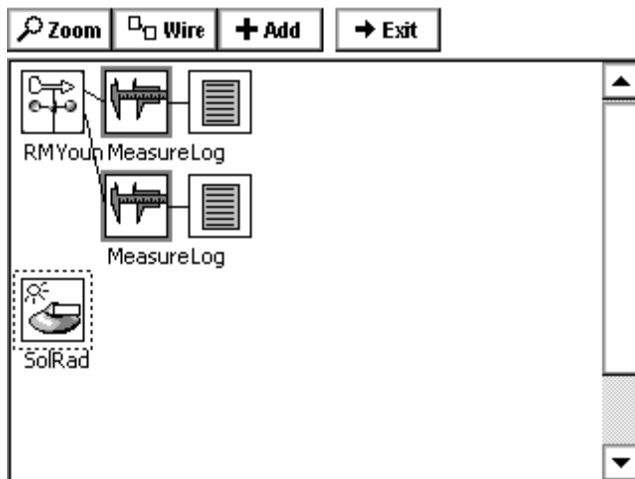

Now we want to unwire the second Measure block. To do this, first click the RMYoung icon and use *Select Output* to select the *Dir(ection)* output. Then click the second Measure block and use *Select Input* to select *Input*. The Setup Diagram will now look like this, with the line connecting the two blocks now in bold:

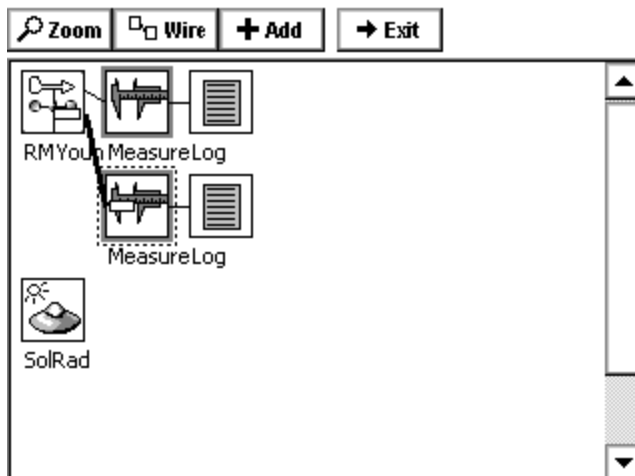

To unhook these two blocks, click the *Wire* button at the top of the screen. The blocks unwired will look like this:

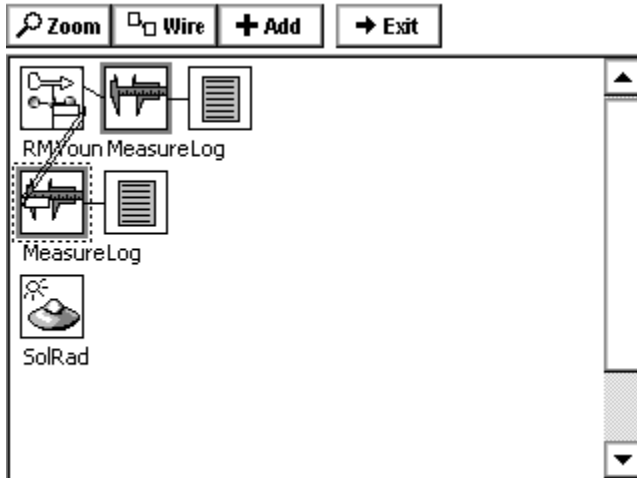

To now hook the measure and log blocks to the new SR sensor we have added, click on the SR icon and use *Select Output* to select its output *SR*:

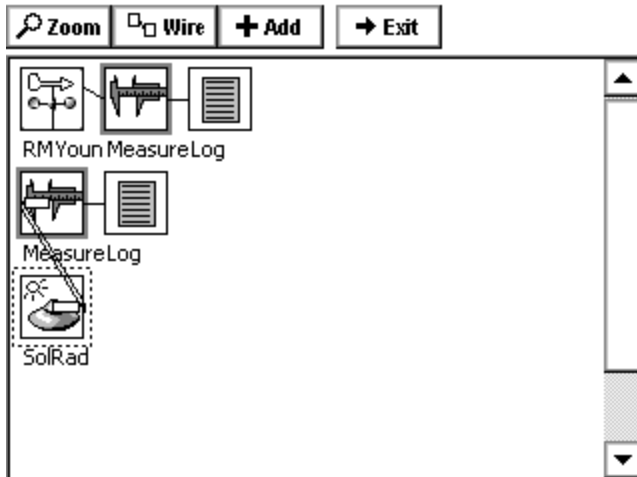

Finally, click the *Wire* button again to get the desired setup:

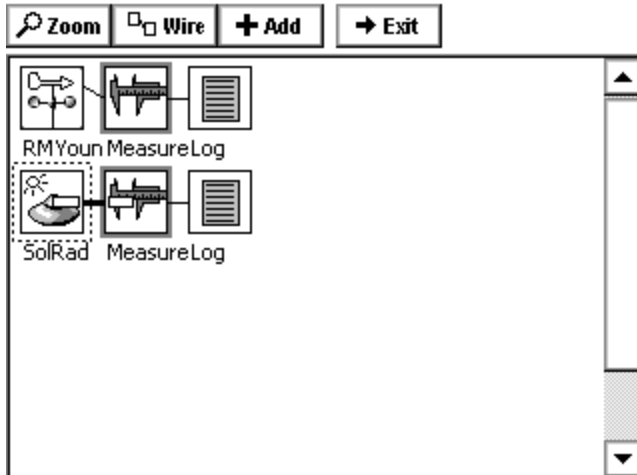

## Deleting a Block

To delete a block, select it and then select *Delete* from the menu that appears. This also deletes the wires coming from that block. For example, if we deleted the second Measure block from above, the resulting Setup Diagram would then look like this:

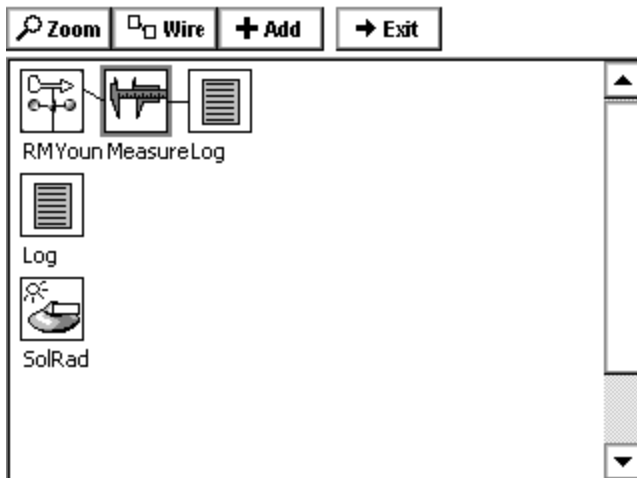

## Deleting Multiple Blocks

To delete multiple blocks, click on the left most block, then select the *Delete Right* menu. All blocks to the right of the selected block will be deleted. In the above blocks, clicking RMYoung and selecting *Delete Right* will delete the RMYoung, Measure and Log with one click.

## Inserting a Block

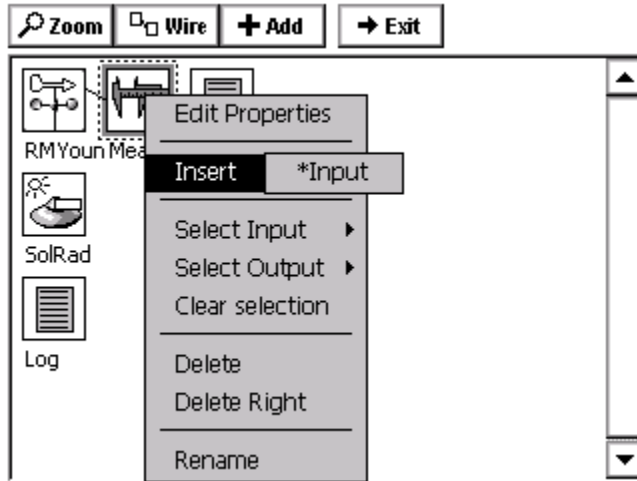

To insert a block into a chain of blocks, simply select a block for the new block to go in front of. So, for the example above, to insert a display block before the measure of the RMYoung, select measure, then insert. Notice the \*Input, if a block with multiple inputs is selected, this would show all available inputs, in the case of measure, only one input is available, so click the \*Input. The Select Category box will be displayed, for this example, select MISC and then select DISPLAY and click OK.

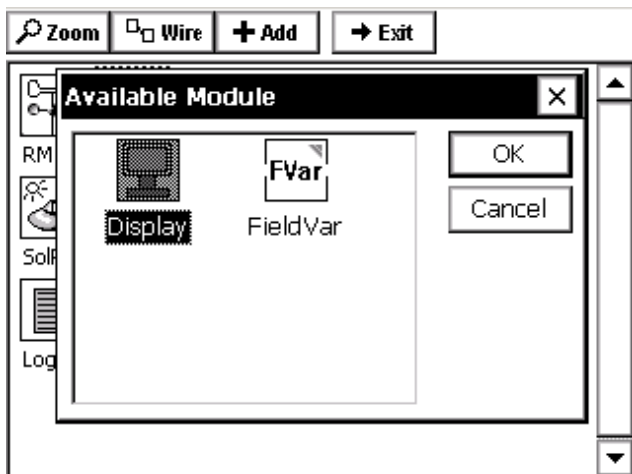

The display is now inserted in front of the measure block.

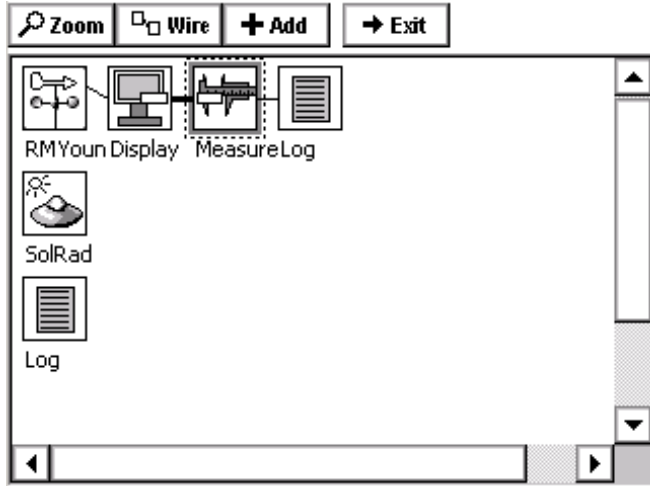

# CHAPTER 5: EXAMPLE SETUPS

## EZSETUP FOR A STREAM GAUGING STATION

---

Setting up a stream gauging station with a shaft encoder is simple. The following setup will use a 15-minute measurement interval, log the data and transmit it to a GOES satellite.

Connect all equipment before entering the setup. For this example setup, hook a Satlink to COM 2 and a Quadrature shaft encoder to Digital channels 3-4 (terminal B I/O 3 and I/O 4)

Log into the system using the SETUP account access.

Start by setting the station name. This name will identify the station and allow the setup file name to be unique. Do this from the *MAIN Tab* by clicking the three dots next to *Station Name:* and typing or clicking the letters on the virtual keyboard. LakeTop is used in this example.

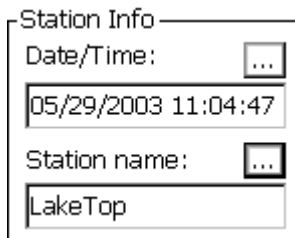

Go to the *Setup Tab*, this is where the rest of the station configuration will take place.

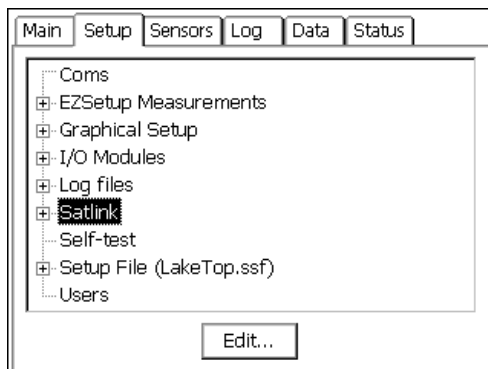

Select the Satlink tree by clicking on it, then, click the *EDIT* button.

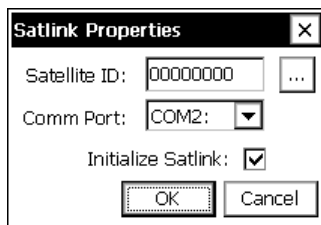

Set the Satellite ID (NESDIS assigned) and COM port Satlink is connected to, and then click *OK*.

If a message saying recording must be turned off appears, click YES, this will stop the system and let the rest of the setup continue. When it asks to restart recording, click NO. Recording doesn't need to start until the entire setup is completed.

Click the plus next to the Satlink tree, then select the Self-Timed branch and click the *EDIT* button. From here, enter all the parameter of the transmission as assigned by NESDIS. For this example, use a 1 hour rate at a 00:00:00 time (offset) and send 8 data values. Also, set the window centering to on and set the window to 15 seconds.

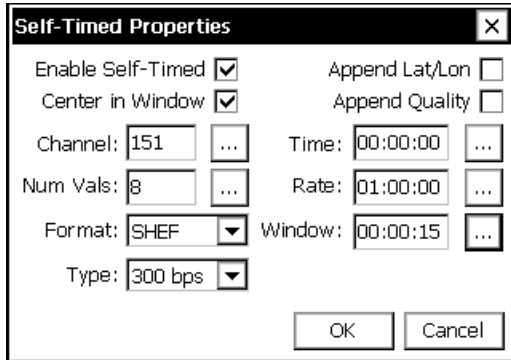

Since this setup is not going to use alarms, no more information is needed for the Satlink setup. If alarms were to be defined, the *RANDOM* tree would be the place to set that information.

Measuring a shaft encoder every 15-minute on a fixed interval is easily accomplished using the new EZSetup tree of the *SETUP Tab*. First, define the measurement interval, then add the sensor and configure it.

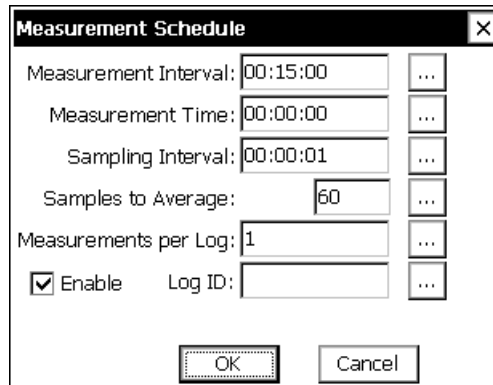
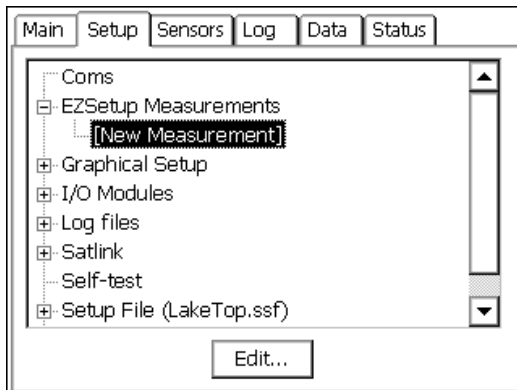

Add the new measurement interval by clicking the plus sign next to EZSetup Measurements, then highlight [New Measurement] and click EDIT.

From here, all parameters for setting up a schedule are shown. For the purpose of this setup, the default values already meet the schedule, so just click OK.

Now that the schedule is defined, a plus sign appears to show that sensors may be added. Click this plus sign to expand the tree, then select [New Sensor] and click EDIT.



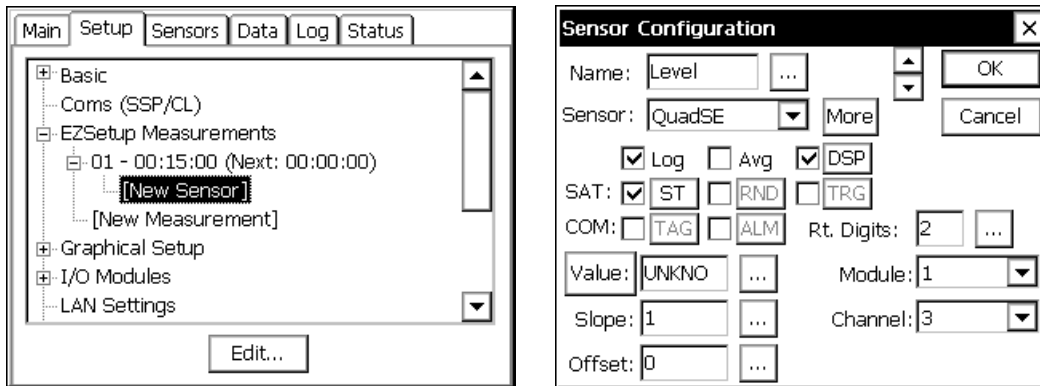

For this example, select a name (Level) select the sensor as a QuadSE, notice the Log and DSP (display on LCD) are already checked, check the ST to send this sensor in a Self Timed transmission, leave default of 2 right digits. Since digital channel one on the built-in digital module cannot be used with a Quadrature shaft encoder, change the channel to 3 (Note: If an external 8080-0002 were used, then channel 1 would be valid).

Click the MORE button to get to the details of the QuadSE properties. See Appendix A to see all the options available for this built-in sensor block. For this setup, leave the defaults.

Click the DSP button to see the properties for the display. It is possible to log a different amount of precision than is displayed on the front panel; the default value used here comes from the Rt. Digits set on the main Sensor Configuration page. For this setup, leave the defaults.

Click the ST button to see the properties for the self-timed transmission. Notice that all the fields are filled in with details previously entered. These details include the Label (From Sensor Configuration), Data Time/Interval (From the EZSetup Measurement schedule), Num Values (From the Self Timed tree under Satlink) and an auto-numbering Sequence (This is the first sensor configured, so it is 1).

Since the transmit format was previously left at the default of SHEF, the Num Values for this sensor are configured here, it is possible to send a different amount of values per sensor. Had BIN-INT (binary interleaved) been selected, this field would display the Num Values set in the Self Timed setup under Satlink tree, but will not allow it to be changed from this properties page. For this setup, leave the defaults.

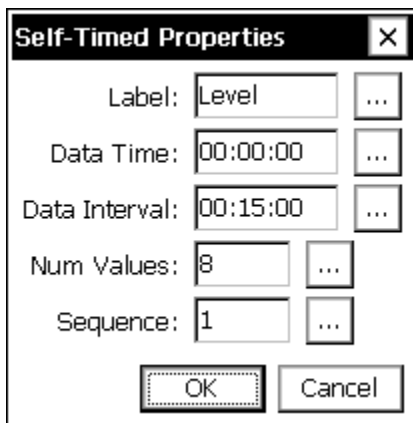

Notice the button labeled [VALUE] and next to it is a box with the letters "UNKNO", this is actually saying "UNKNOWN VALUE" because it has never been measured. Because all the parameters needed to make this measurement have now been configured, press the [VALUE] button to force a live measurement.

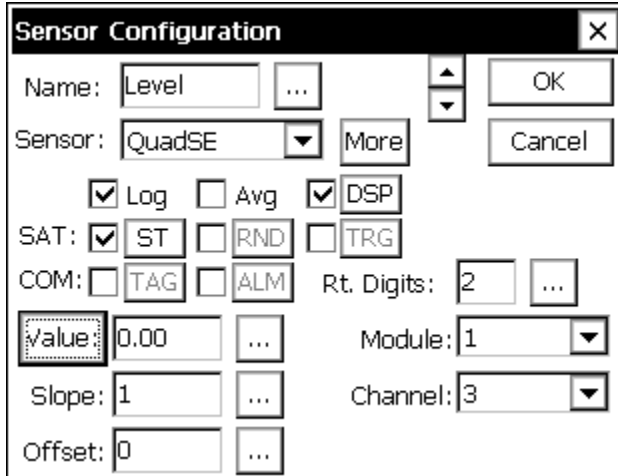

Now, the box is displaying the current value (0.00 in the picture). To set the level to match the actual level (calibration), simply press the three-dot box [...] next to the data, enter the desired reading, and the system now has calculated the offset. Since this example has 0.00 in it, the offset will match what is entered, had the system been running for a while, and had an actual reading, it would have re-calculated the necessary offset automatically. Click OK to save these changes.

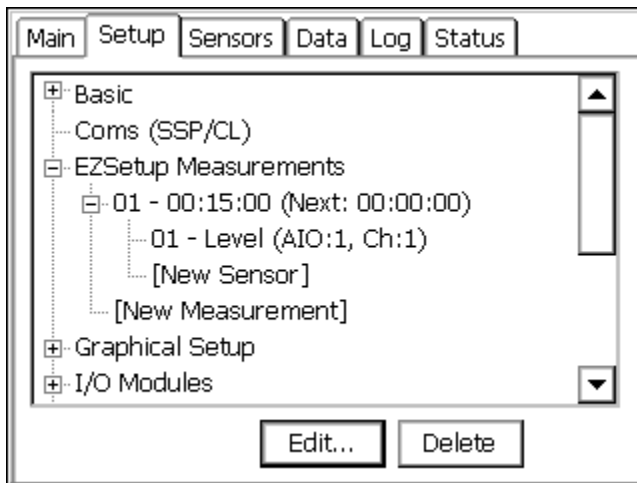

Now the system displays that it has an EZSetup measurement defined, and that a sensor has been placed into that measurement.

Adding more sensors to that measurement is done by selecting the [New Sensor] and repeating the previous steps, selecting the appropriate sensor type, IO module, Channel , etc.

Creating an additional EZSetup measurement, to add hourly averages for example, is done by selecting [New Measurement] and repeating the previous steps, including adding what sensors to measure by this new schedule.

REMEMBER, defining a schedule does no good without defining the sensors below it. So, to add an hourly average of the QuadSE sensor previously setup on the fifteen-minute interval:

Define a new EZSetup measurement, this time setup the Measurement interval to hourly, set the sampling interval to the desired time, and set the number of samples (If one minute interval is used, number of samples could be set to 60 to take samples for the whole hour)

Add a new sensor with the same IO module and channel as previously defined to get the data from the same shaft encoder.

Check the box labeled AVG on the Sensor Configuration screen.

Once the setup is completed, go to the main tab and press START recording.

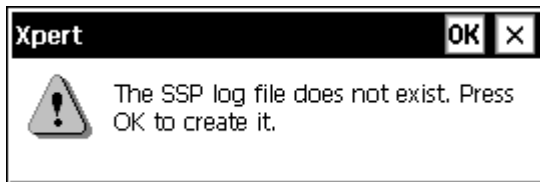

Before leaving the setup tab, a special log file must be created, SSP.log, it is only 'special' because this is where EZSetup places all sensors and this is where communications interfaces look to get 'TAG' data. Had this log file been created already, this warning message would not have appeared. Since the system has detected this log file does not exist it has asked to create one. For this example setup, click OK, and create the default size SSP.LOG file for now. See Chapter 3 - Log Files for more details on this.

Now, that the SSP.log file is created, go to the MAIN tab and press START recording.

That's it! The system is recording data and is going to transmit it on the GOES transmitter.

## GRAPHICAL SETUP TO COMPUTE DAILY MIN/MAX

For this example, a 0-5 VDC level sensor, with a 10ft range is used. The last measured value, daily minimum, maximum, time of minimum and time of maximum are displayed on the front LCD and logged. It is a good idea to first draw out in a notebook the desired flow of data, at first simply write down what data needs collected and if it is just logged, or displayed, or both. Then, look through the manual, if an input block exists to make the measurement, use it, if not, find a generic input block (VDC for voltages).

In this example, the data also needs to be processed for daily minimum/maximums. So a special block is needed, this block has already been defined and is provided in the default 9210 library, had it not been included, it would need to be developed, either by Sutron, or by using the software development kit.

Once the measurements have been defined, and the associated blocks needed to do the measurements have been identified, it is time to start building the setup. Below is the result of building the Graphical setup, block-by-block, starting at the left. This was done without the use of the wizard, since multiple outputs and blocks were needed.

Here is the graphical setup:

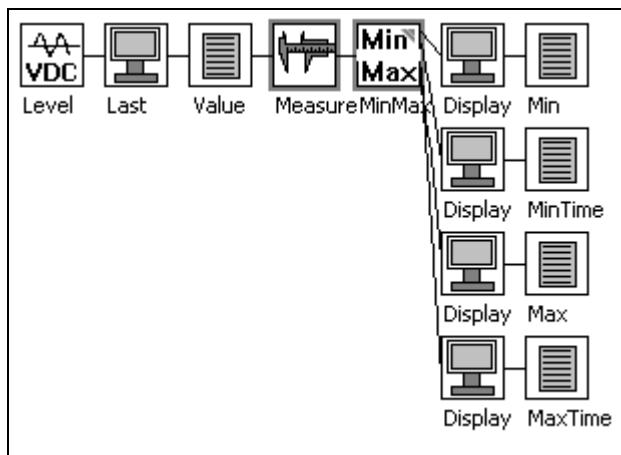

It may look complicated at first, but by looking at it piece by piece it will make sense.

Note that in the graphical setup, data is flowing from left to right. So in the above example:

At the far left is where the data is connected, an analog channel measured by a VDC block.

Next is a display block, this tells the system to display all data that passes through this point (last measured value in this case).

Not only is the data displayed, but it is also logged by placing a log block directly after the display. The log could be placed before the display, but anytime a measurement is forced from the front panel, it would be logged.

Next, is the measure block. This tells the system how often to take readings.

Directly after the measure is the MIN/MAX block. This block also has a schedule that tells the system how often it should compute minimums and maximums (every 24 hours starting at midnight in this example).

The rest of the blocks are wired to the output of the MIN/MAX block. The values are displayed on the LCD and logged. The only output not wired, is the *COUNT* output, this output tells the number of samples used for calculations and was not needed for this setup.

Notice the blocks have been renamed, renaming the blocks will help in maintaining the setup by making it easier to read.

In this example, no satellite transmissions have been defined. Adding transmission parameters is easy. Simply select the output data to transmit by selecting a point (typically a log block) and selecting its output. Then add a self-timed parameter or random trigger block as needed.

Unlike the EZSetup, every block in the Graphical setup must have the parameters defined separately. EZSetup will pass through many of the parameters from one screen to another, because all data is maintained and entered in a specific order. In the Graphical setup, the order of the blocks is not known, and, in some cases, one output may go to several other blocks. For example, in the EZSetup, the label of the sensor is passed into the display parameters for the label of the LCD. In the graphical setup, the label (level) would not make any sense if it were passed into all the blocks that followed it, because additional processing was done to get computed values that are no longer just the level.

# **Chapter 6: Operation with a PC running XTerm**

# INTRODUCTION

---

Sutron has designed the 9210 so that setup and operation is accomplished by a Windows-based personal computer (PC) running a program called XTerm. XTerm supports several connection methods to access both local (serial port connection) and remote 9210s, e.g., those connected by modem. This section describes how to use XTerm.

Sutron provides two versions of XTerm. One version is intended for desktop PCs running Microsoft Windows. The other version is intended for PocketPC devices like the HP iPaq and Dell Axim. The two programs perform essentially the same functions, with the biggest difference being that XTerm for the PocketPC displays the screen rotated 90 degrees. XTerm does this because the aspect ratio of the PocketPC screen is the same as the 9210s except it is rotated. This ensures the user can see the screen with maximum resolution.

## Installing XTerm

There is no special installation needed for XTerm on a desktop PC. Simply copy it to any folder on the PC.

Always make sure you have the latest version of XTerm, which can be downloaded from Sutron's website. The version of XTerm on your PC can be found by selecting "About XTerm..." in the XTerm System menu, which is accessed by clicking the "X" in the upper left menu bar.

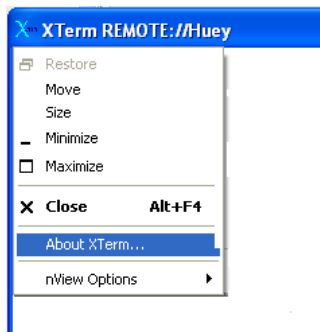

To install XTerm on a PocketPC, run its installation program from a desktop PC that already has ActiveSync 3.1+ installed (this is a Microsoft program that is typically supplied by the vendor of the PocketPC device, and is typically installed as part of the software that comes with the PocketPC. At the time of this writing, ActiveSync may be downloaded from <http://www.microsoft.com/mobile/pocketpc/downloads/activesync35.asp>).

Start Xterm and the following screen is displayed. From here, specify and configure the type of communication link to use (desktop PC shown left, PocketPC shown right):

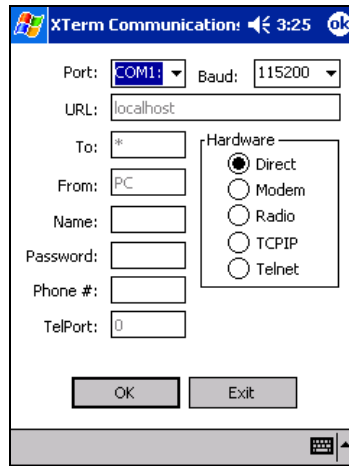
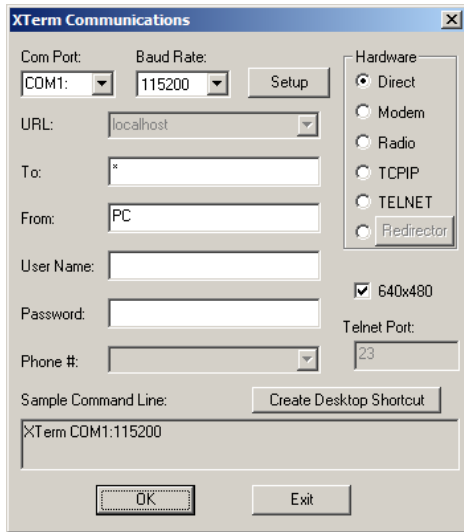

Use the controls on the screen to select the com port, baud rate, type of connection (direct, modem, radio, TCP/IP, Telnet), 640X480 (“big screen” mode when selected) and related values. Setup is an advanced option that allows the SSP timings to be modified to accommodate different types of connections. Select OK and XTerm will begin operation with the type of communications selected.

Connection types are as follows:

Direct: Serial cable from Xpert to PC

Modem: Allows XTerm to dial out on a pc modem to a Xpert with modem

Radio: Allows XTerm to control a line of site radio to talk to a Xpert

TCP/IP: Allows XTerm to communicate with a networked Xpert2. If the Xpert2 is connected to a firewall, and TCP/IP access is desired, than the firewall must be configured such that connections on TCP port 52733 will be allowed to the Xpert2. This option may also be used to connect to an Xpert indirectly through another copy of Xterm running on a PC at the IP address specified (Useful to assist other users, since all actions performed on remote pc are viewed at the pc connected to the Xpert/9210).

Telnet: Allows XTerm to communicate with a networked Xpert2 running V3.2 or later of Remote. If the Xpert2 is connected to a firewall, and telnet access is desired, than the firewall must be configured such that connections on TCP port 23 will be allowed to the Xpert2. In general the TCP/IP option is quicker because it has less overhead, but since command line access occurs over telnet port 23, Xterm and command line can share the telnet port, if desired, limiting the number of ports that must be opened in the firewall.

Redirector: Allows XTerm to communicate to a station hosted by the Sutron Redirector service. Pressing the Redirector button will allow to specify the user name and password assigned to you by Sutron for this purpose. You select the station you wish to connect to by entering its name in the URL: box, or you may select it from the list of stations you own by pressing the Detect button.

XTerm for the PocketPC does not show the 640x480 “big screen” option since its screen is too small. The sample command line text area is also missing since the PocketPC does not have a command line.



To configure XTerm to remember selections when run from a desktop PC, press the **Create Desktop Shortcut** button. If you have entered passwords, you will be prompted if you wish to store them in the shortcut. A shortcut that specifies the options you have selected will be placed on the Windows desktop.

Many shortcuts to XTerm may be created, each with a different com port or configuration. Once the shortcut has this additional information, XTerm will not display the communications configuration screen when it starts.

## Automatic Detection of 9210s on a Network

When connecting to a networked 9210 using the TCP/IP or Telnet options, a Detect button will appear next to the URL box. Pressing the Detect button will display a list of 9210 stations that are currently on the network. For each 9210 found, the list will show the IP address, version number of Remote.exe, model, and serial number. Selecting a station and pressing OK will copy that station's IP address in to the URL box. If Xterm is unable to detect a station, it may be because an exception has not been created for Xterm in Windows Firewall (requires access to UDP port 52733), or perhaps because the 9210 is running firmware older than 3.2, before this feature was introduced.

The Detect button may also be used in conjunction with the Redirector option to list the stations you own that are hosted by the Sutron Redirector service.

## SSP Settings

The Setup button will display the SSP Settings screen containing advanced options for controlling the timing of SSP messages. XTerm is optimized for a 115.2K baud direct connection, and other settings are often necessary for slower or less-reliable connections.

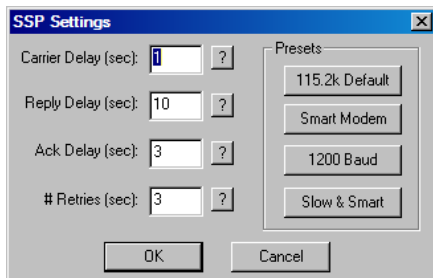

Below is a description of each option and is the same description provided when the corresponding help button (“?”) is pressed:

**Carrier Delay (seconds):** When the com port is set for ""RADIO"" communications, this is how long to key the transmitter (assert DTR) to warm up the radio before sending data. With Sutron radios typically 1 second or less is needed, but this may need to be increased if hardware repeaters are used in the network, as each hard-repeater in the network needs time to warm-up. Default 1 sec.

**Reply Delay (seconds) :** This is how long the XTerm will wait for a reply before timing out. This delay includes the time needed for all retries to occur, so it's typically set to the value of AckDelay \* (# Retries). Default 10 seconds.

Ack Delay (seconds): This is how long to wait for a response to a message (aka an acknowledgement) before attempting a retry. The default value is 3 seconds, which is suitable for a 115.2K baud direct connection. 10 seconds is recommended for a single hop 1200 baud system connection. It should be increased if lower-baud rates or store and forward repeater hops are necessary.

# Retries: More precisely, this is the total number of tries. When an SSP request is made that requires a reply the system will wait for the Ack Delay for the reply. If a reply is not received then one or more retries is performed. # Retries is the total number of attempts to make. The default value is 3. Combined with the default Ack Delay of 3 seconds, this means SSP will send the same message as many as 3 times, with a 3 second delay between each attempt before it will timeout and report a ""tx error"". All retry messages have the same FLAG SEQUENCE number as the original message. This is used to prevent the same message from being processed twice due to a long network delay.

The preset buttons set the SSP timing according to 3 common scenarios. The 115.2k puts the values back to their defaults. Smart Modem selects a very long (1 minute) ack delay and reply delay since it's expected the smart modem will perform retries, and will normally never fail, but may take a while to send data when line conditions are poor. The "Slow & Smart" settings are similar to the Smart Modem settings but include other enhancements to help Xterm perform over a high latency but reliable connection such as a TCP/IP based cell phone modem. Eliminating retries which would only conflict with the previous message still being sent is one such improvement. "Slow & Smart" may also be selected from the command line with the /SLOW option. 1200 baud selects settings designed to work with lower-baud rates and dumb radio systems.

## Redirector Settings

The Redirector button will display the Redirector Connection Settings screen containing options for connecting to a station hosted on the Sutron Redirector service.

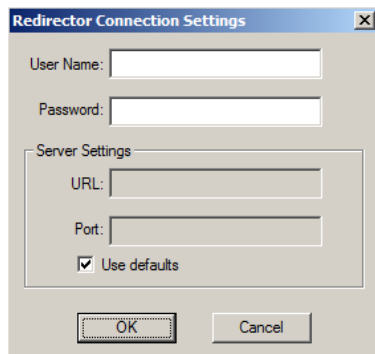

The image shows a dialog box titled "Redirector Connection Settings". It has a standard Windows-style title bar with a close button (X). The dialog contains the following elements:

- A text input field labeled "User Name:".
- A text input field labeled "Password:".
- A section titled "Server Settings" which is collapsed, containing:
  - A text input field labeled "URL:".
  - A text input field labeled "Port:".
  - A checked checkbox labeled "Use defaults".
- Two buttons at the bottom: "OK" and "Cancel".

Below is a description of each option:

User Name: The name you were assigned to access the Sutron Redirector service.

Password: The password you were assigned to access the Sutron Redirector service.

URL: The IP address or URL of a custom Redirector service.

Port: The port number of a custom Redirector service.

Use defaults: Check this if you wish to specify custom values for the Redirector service URL or port number – otherwise the settings for the Sutron Redirector service will be used.

#### Troubleshooting:

If you are unable to access the Redirector service, check to make sure your user name and password were specified correctly. If that doesn't resolve the issue, check with your network administrator that you have rights to access `redirector.sutron.com` on port 80. If your organization blocks non-Web access on port 80, you may also try specifying the URL `redirector.sutron.com` and port 23 under Server Settings.

## Preparing the 9210 to work with XTerm

The 9210 is configured at the factory to communicate with XTerm on its COM1 serial port at 115,200 baud. Connect a standard RS-232 DB9 cable between the PC and the 9210. A M-M gender changer and a Null Modem are necessary to connect 9210 to the PocketPC.

The program in the 9210 responsible for communicating with XTerm is *remote.exe*. When the 9210 starts up, it will check for an *autoexec.bat* file in the *\flash disk* folder. If an *autoexec.bat* file is not found the system will automatically run *remote.exe on COM 1*. If the file is found, the system will execute the contents of *autoexec.bat*. In this case, *remote.exe* will only run if there is a line in the file to run it.

In the event that a system has an *autoexec.bat* file that does not run *remote.exe* and it is needed. Connect a terminal program to com1, (set to 115200, 8N1), apply power to the unit and hold down CTRL C (ctrl key and C key at same time). This will bypass the *autoexec.bat* file and always run *remote.exe* from the *\windows* directory. Once this is done, a new *autoexec.bat* may be transferred to the unit, using XTerm. NOTE: this procedure will not run *Xpert.exe*, so connecting with XTerm will show a blank screen.

## Operating XTerm

When XTerm communicates with a 9210 that has user accounts setup, a username and password must be supplied to gain access. When this happens, simply enter a valid username and password.

When XTerm starts, it will look similar to the window below, with the left portion displaying the contents of the 9210. The entire screen of the PocketPC display shows the contents of the 9210.

Click (or tap in the case of the PocketPC) in the 9210 portion of the display and the software will respond accordingly. The only exception to this is on the PocketPC: tap-and-hold the stylus against the screen for a few seconds to display XTerm's main menu. The options on this menu are the same as those provided by the buttons on the right-hand side of the desktop version.

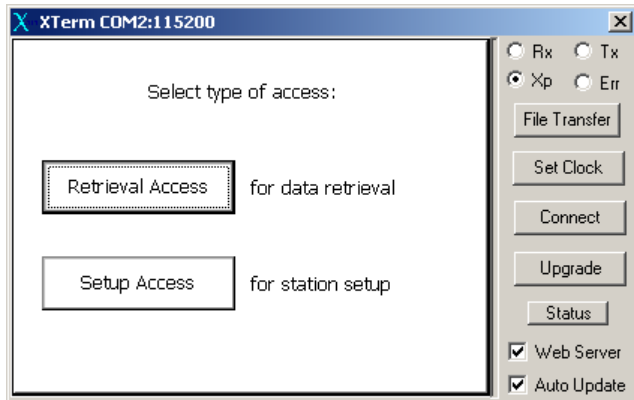

If the screen is blank, or becomes unreadable or garbled, right click in the 9210-display area. This sends a command to retrieve again the contents of the display. To do this on the PocketPC, tap and hold the stylus on the screen to access the main menu, and then select “Update Now”.

XTerm is very smart when it comes to knowing when and how to update its display. However, the nature of serial communications sometimes causes screen updates to lag slightly, or become garbled. As an example, login to the 9210 and select the different tabs across the top. Notice that it takes time to switch from one tab to another. If connected at a baud rate slower than 115,200, the display update can be even longer. If a control is selected, but doesn't immediately respond, wait a bit and try again. **Do not click controls rapidly** as this will translate into undesired behavior.

When using the desktop version of XTerm, the desktop's keyboard will work as if it were connected. For example, instead of using the 9210's virtual keypad (shown below), use the PC keyboard. The characters typed are sent to the 9210.

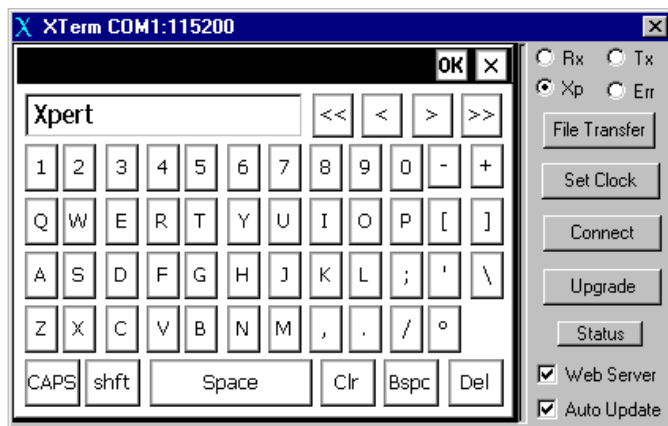

When exporting logs using XTerm, XTerm will try to save the exported log on the local PC, and so offers a Save-As dialog on the local PC (see below: desktop PC shown left, PocketPC shown right). If this dialog is cancelled, then a prompt for the destination on the 9210 flash disk is displayed.

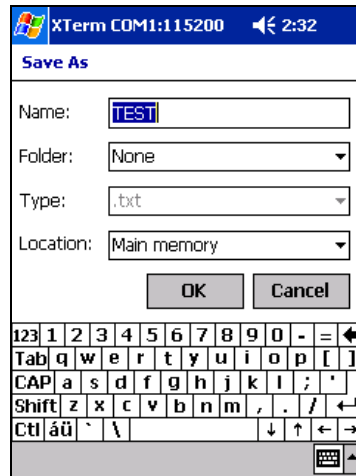
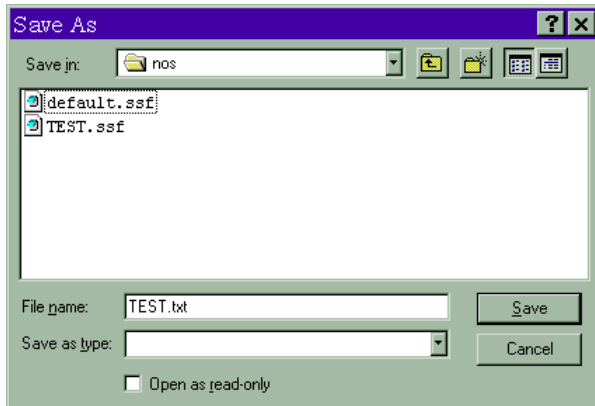

## File Transfer

File Transfer is one of the more powerful features of XTerm. Use File Transfer to send setups and software between the 9210 and PC. In addition, access to special virtual files in the 9210, that describe details about the software, are available.

When File Transfer is selected, a window similar to the following appears (desktop PC shown left, PocketPC shown right):

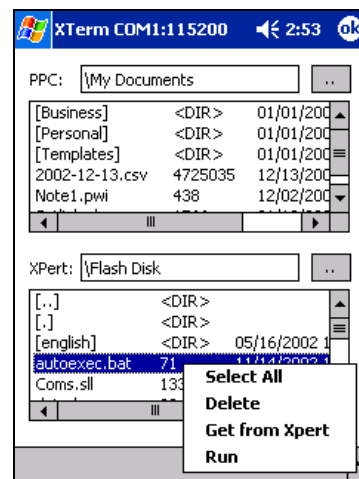
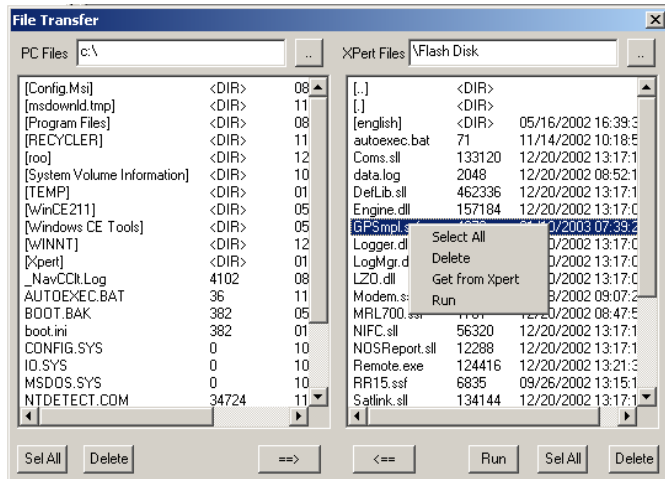

The list on the left (top for PocketPC) shows the files on the PC. The list on the right (bottom for PocketPC) shows the files on the 9210. The folder that is displayed is changed by simply double clicking on a folder in the window. Selecting the [three dots] control at the top of the window next to the folder name or [...] in the list of files will go to the parent folder.

All operations on the file lists can be selected from the file transfer popup menu (shown in the images above). This menu is accessed on the desktop PC by right clicking in the list. This menu is accessed on the PocketPC by tapping-and-holding the stylus on the list for a second or two. The desktop PC version also provides buttons to access these operations.

To move a file from the PC to the 9210, select the file in the PC window and either press the ==> button, or select "Send to 9210" from the menu. To move a file from the 9210 to the PC, select

the file in the 9210 window and either press the <== button, or select “Get from 9210” from the menu.

On the desktop PC, select multiple files by pressing CTRL and then selecting the file with the mouse, or by pressing SHIFT and then selecting the file with the mouse to select a range of files. On the PocketPC, select multiple files by pressing and holding the “Action” button and tap the additional files. The “Action” button is typically the largest button on the device below the screen. See the PocketPC documentation for further information.

Use either the *Sel All* button or the “Select All” menu item to select all items in the list.

Use either the *Delete* button or the Delete menu item to delete files on either the PC or 9210.

Use either the *Run* button or the “Run” menu item to run a program on the 9210. Note that it is not possible to run a program with command line arguments in this way.

Note that all times displayed on the right side of the file transfer dialog (top, on the Pocket PC), are shown in device-time, which knows nothing about “local” time. All times displayed on the left side (bottom, on the Pocket PC), are shown in PC-time, which reflects a correction for the PC’s local time-zone. This can lead to some confusing behavior when the PC’s local time zone is set to something other than Greenwich Mean Time (GMT), as certainly many are. For example, if you transfer a file from the 9210 to the PC, the file timestamp shown on the PC will be different than what is shown on the 9210. The key to working through this confusion is to remember the times shown in both cases are each relative to the device on which the file sits (the 9210 or PC).

## Process List Folder

The virtual files under the Process List virtual directory give important details on what programs are running in the 9210. The files are “virtual” in that they do not exist physically as files on the 9210. The information is organized in this fashion to make it easier to view and transfer for analysis. A sample Process list is shown below. Note that it can take 10 seconds or more for the system to produce the Process List.

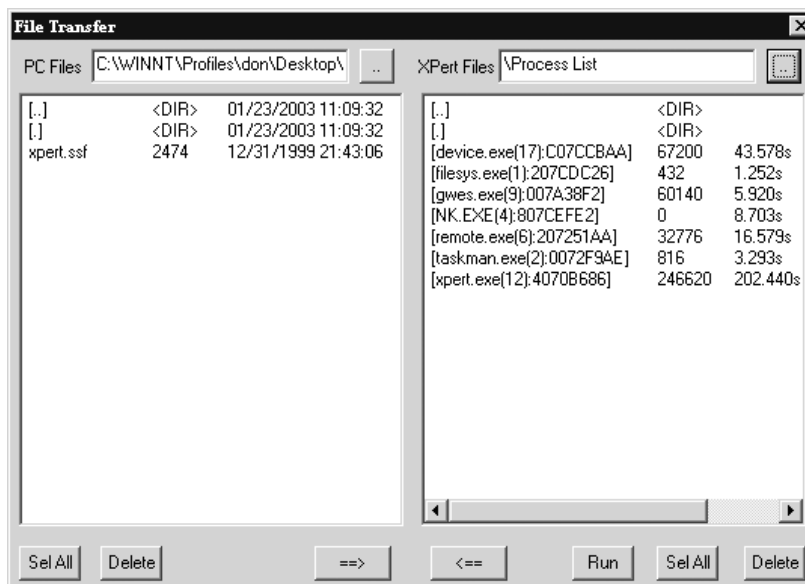

The format of the process information is [name (threads):address] size and time. Where name is the file name of the process running, threads is the count of threads running, address is the where in memory the program is running, size is the number of bytes used by the program and time is the amount of CPU time in seconds that the program has used.

Double click on any of the processes and the system will allow threads or heaps to be selected. A sample thread display is shown below:

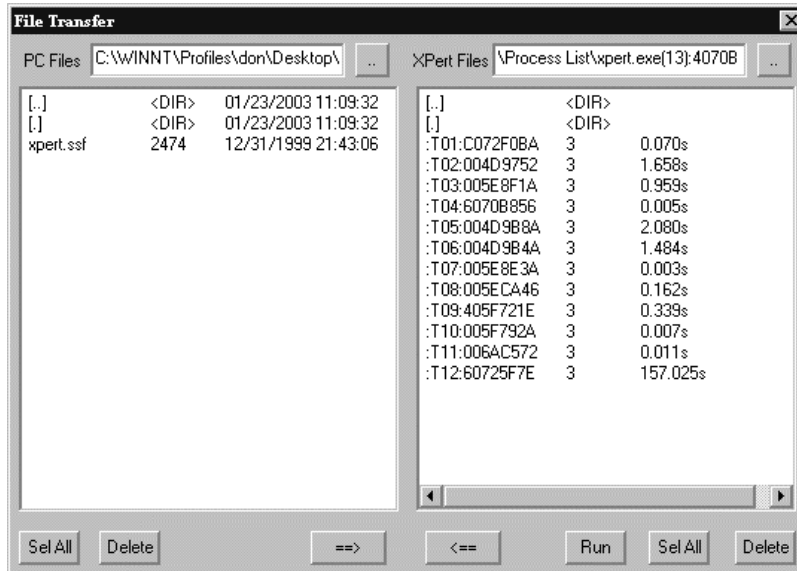

## Set Clock

When you press the *Set Clock* button, XTerm prompts, “Would you like to set the 9210’s time to match your PC”. If you press YES, the 9210’s clock will be set to match the PC clock. Press NO if you do not wish the time to be set.

## Connect

Pressing the *Connect* button brings up the configuration dialog shown and described in the section on installing XTerm. This allows you to change your connection once XTerm has been started.

## Upgrade

Pressing the *Upgrade* button brings up a dialog asking for the location of the upgrade file to use to perform a scripted upgrade of the firmware in the 9210. Please see **Appendix B** for more information on how to upgrade.

## Web Server

The Web Server check box selects whether or not XTerm should act as a web server proxy for the 9210. When this box is checked, any web pages on the 9210 will be made available as-if they were actually hosted on your PC. For instance, in Internet Explorer you could enter the URL



http://localhost to access the 9210's homepage. If your PC is on a LAN, WAN, or the Internet, then the 9210's home page can be reached by other users by entering http://yourIPorURL.

## Auto Update

The auto update checkbox causes XTerm to continuously request screen updates. When the checkbox is clear, XTerm will conserve the 9210's power and CPU by only requesting updates for a short time after a key press or a touch.

## Station Operations

Right clicking the mouse on the right hand pane (where the “Right click for more options” is displayed) will bring up the Station Operations menu. The menu has options to perform a Startup, Shutdown, or Reboot. A confirmation dialog will be displayed before any of these commands are sent to the station. If the operation cannot be supported due to insufficient access rights or a lack of support in the RTU firmware, a message will be displayed.

### Startup

The startup option may be used to start up the main application of the RTU (ex: Xpert.exe). This will also re-configure the Autoexec.bat file on the station if needed.

### Shutdown

The shutdown option may be used to initiate a shutdown of main application of the RTU (ex: Xpert.exe). One purpose for shutting down the main application would be if you wanted to transfer a new copy of an SLL to the unit without performing a full upgrade. If you don't allow enough time for the application to fully shutdown, you will receive an error when you try to transfer the file over.

### Reboot

The reboot option may be used to gracefully shutdown the unit and reboot it. This is always preferred over just removing power. For instance, the system will startup much quicker if the log files have been closed out normally and don't need to be rescanned.

## FireWalls

If you have “Windows Firewall” enabled (like most PCs do these days) you will need to add an “exception” for Xterm.exe in order for it to support all of its networking features. If you use a different type of firewall, you may need to add an explicit access rule for some of the following service ports that are used by Xterm or the 9210 :

| <u>SERVICE</u> | <u>PORT</u> | <u>PROTOCOL</u> | <u>HOSTED BY</u>     | <u>DESCRIPTION</u>  |
|----------------|-------------|-----------------|----------------------|---|
| GUI            | 52732       | TCP             | 9210<br>and<br>Xterm | Used by Xterm to perform log dumps and detect that the 9210 application is running. Xterm also hosts this port in order to support proxy connections. |



| <u>SERVICE</u> | <u>PORT</u> | <u>PROTOCOL</u> | <u>HOSTED BY</u> | <u>DESCRIPTION</u>   |
|----------------|-------------|-----------------|------------------|--|
|                |             |                 |                  | Serial and Telnet connections make use of Xterm's proxy.   |
| REMOTE         | 52733       | TCP             | Remote and Xterm | Used by Xterm to access GUI screens and perform file transfers. Xterm also hosts this port in order to support proxy connections. Serial and Telnet connections make use of Xterm's proxy.                           |
| AUTO DETECT    | 52733       | UDP             | Remote           | Used by Xterm to detect 9210s running on the network.  |
| SSP            | 52734       | TCP             | 9210             | Used by Remote when it needs to communicate with the 9210 application. This port is used locally by the 9210 and there's no reason to open the port on the PC or in a firewall. Doing so may create a security risk. |
| TELNET         | 23          | TCP             | Remote           | Used to support telnet based command line or GUI access (screens and file transfer).   |
| WEB            | 80          | TCP             | 9210 and Xterm   | Used by the 9210's web server and Xterm's proxy web server.  |

## Configuring the PC modem for use with Xterm

Most PC modems will work with Xterm without any additional configuration needed, simply select the com port the modem is using from the com port drop down box, select the hardware type as modem, and set the baud rate (if needed), and enter the phone number.

If Xterm gives this dialog:



Then check to make sure no other program is using the modem and that the correct com port is selected.

If Xterm gives this dialog:



First check that the phone number has been entered correctly (enter 1 and area code if needed). Then, use HyperTerminal (or other terminal program) and connect to the com port the modem is on. Issue an AT&F command and see OK, if you do not see an OK, then the modem is not working, or is not on that com port. If you get the OK, then issue an AT&FV1&W command to the modem, then close the terminal program and try Xterm again.

## Status and Rx, Tx, Xp, Err indicators

XTerm features four status indicators:

Rx: Flashes when a message is received.

Tx: Flashes when a message is sent.

Xp: Is lit when XTerm has detected that the 9210 application is running and that communications necessary for a log dump has occurred.

Err: Flashes when a message is received that has errors. If you see this often, then your serial cable may be suffering from crosstalk (be wary of very thin serial cables designed to be used for a pc mouse, as these are designed for low baud rates), or your PC may not be capable of keeping up with 115.2K baud serial communication. You could try a slower baud rate (57.6K baud) or a different com port. USB serial ports may have more problems with higher speeds than legacy ports.

The Status button brings up the Communication Status window:

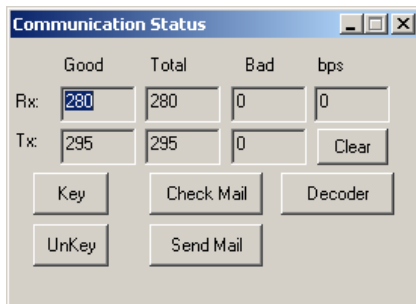

The Status screen displays information about the current session and allows some testing of the SSP (Sutron Standard Protocol) connection:

Rx Good: Number of SSP messages received addressed to your PC;

Rx Total: Total messages received. SSP supports multi-drop (most common with LOS radio systems) where messages can be sent to any station in a network;

Rx Bad: Number of bad SSP messages detected. This would be messages which could not pass a CRC-16 check.

Tx Good: Number of SSP messages transmitted, and acknowledged.

Tx Total: Number SSP messages attempted.

Tx Bad: Number of times an SSP message could not be sent.

Clear: Sets all the statistics to zero.

Bps: The number of bits received and or transmitted per second (computed using a 2-second moving average). If screen updates or file transfers seem sluggish it might be because you're not achieving a very high (bps). This can be caused for numerous reasons including an underpowered PC, communication errors, or just that the 9210 is very busy with processing. The rate achieved will vary depending on what's being performed. For instance, under even the best circumstances, a file transfer to the 9210 will be limited by how fast the Flash Disk can be written.

Key: This keys (powers on) a radio transmitter (asserts DTR and RTS) and can only be used when XTerm is configured to communicate with a LOS Radio.

UnKey: This unkeys a radio transmitter (drops DTR and RTS) and can only be used when XTerm is configured to communicate with a LOS Radio.

Check Mail: This checks to see if you've received a mail message via SSP. When a mail message is received you may hear a beep or the RingOut.Wav file played if it's on your system. If you wish to test this, you can go to the Setup menu on the 9210, select Coms (SSP/CL), press Edit, press Test, and click Send Mail.

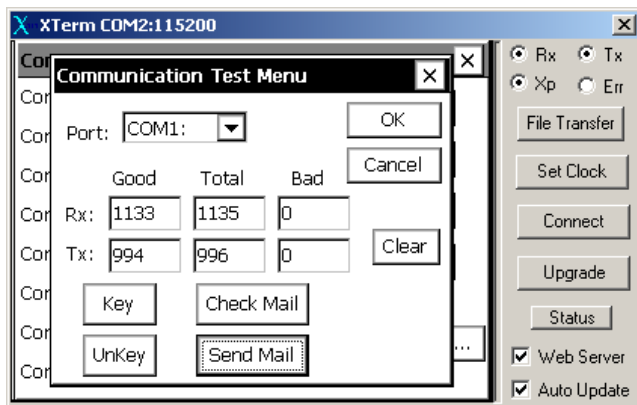

Send Mail: This will prompt for a mail message to send to an 9210. If successful "Mail Delivered" will be displayed.

Decoder: This is an SSP message decoder that can be helpful for trouble shooting SSP communication problems. The information displayed requires an understanding of the SSP protocol, which is beyond the scope of this manual. However, if you experience some sort of

repeatable communication failure, a screen capture of the Decoder window can very helpful to Sutron support staff in figuring out what's going wrong.

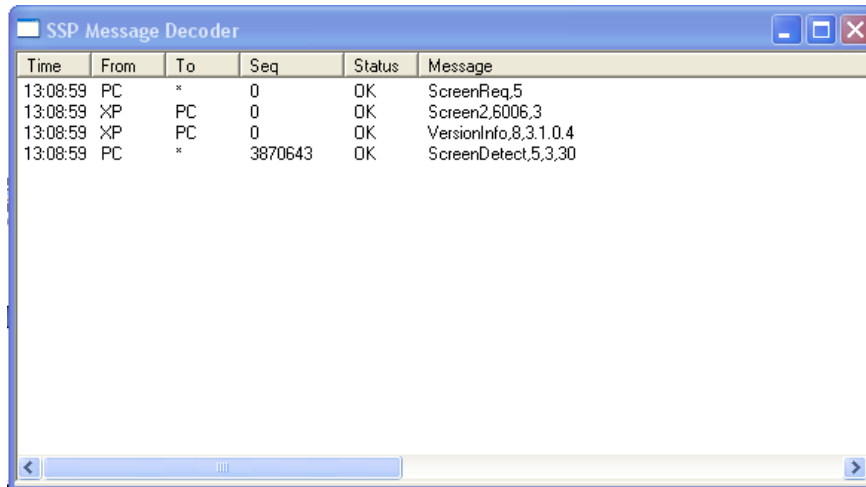

The screenshot shows a window titled "SSP Message Decoder" with a table of messages. The table has columns for Time, From, To, Seq, Status, and Message. The messages are as follows:

| Time     | From | To | Seq     | Status | Message               |
|----------|------|----|---------|--------|-----------------------|
| 13:08:59 | PC   | *  | 0       | OK     | ScreenReq,5           |
| 13:08:59 | XP   | PC | 0       | OK     | Screen2,6006,3        |
| 13:08:59 | XP   | PC | 0       | OK     | VersionInfo,8,3,1.0.4 |
| 13:08:59 | PC   | *  | 3870643 | OK     | ScreenDetect,5,3,30   |

## Special Command Line Options

XTerm supports some special options which are not configurable through the CONNECT screen and must be passed on the command line.

/NOHS - disables H/W Handshaking (flow control) allowing Xterm to be used over a 3-line serial port.

/STATS - causes the "Communication Status" screen to be displayed on startup.

/DECODER - causes the "SSP Message Decoder" screen to be displayed on startup.

# **Chapter 7: Installation**

## STEPS TO INSTALL A 9210

---

41. Connect Earth Ground to the Earth connection on the 9210. The earth connection is labeled GND. **WARNING:** Failure to ground the 9210 can make it susceptible to malfunction or damage by surges and other types of interference.
42. Optional: Wire sensors to the SDI-12 port on the 9210. You can insert multiple wires into each connection. If the connection is awkward to use, run wires to a separate terminal strip.
43. Optional: Wire sensors to the terminal strips as needed.
44. Optional: Connect SATLINK, SPEECH/MODEM or other communication devices to the desired communications port COM2, COM3. The 9210 is wired as DTE so use a straight cable to make the connection. If you are connecting a modem or other devices to the 9210, you will need to configure it in the setup.
45. Connect a PC to COM1 using a straight through cable. Start XTERM and press CONNECT.
46. Connect power to the 9210.
47. Select Setup Access and log into the 9210.
48. If you will be using a voice modem, transfer to the 9210 the desired speech files. Basic speech files needed for normal operations are included in the /windows directory on the 9210. The speech files take up considerable space on the flash disk. Therefore, you will only want to send to the 9210 the files you expect to need. The speech files are found on the CDROM provided by Sutron. The speech files can also be downloaded from the Sutron web site. On the CDROM, files in the ENGLISH-EXTRA should only be loaded as needed. Use XTerm to transfer the files to the appropriate folder in the \flash disk\speech\ (\English, \Spanish etc.). If the folders do not exist in the 9210, use HyperTerminal and issue the MD command to create the desired folders. If you want to create your own speech files, refer to the procedure given in Appendix F.
49. If you have a setup file(s) for the 9210 (default.ssf or anyone.ssf) use XTerm to load them into the flash disk. When the 9210 starts, it will first try to load a setup file that matches the station name. If it doesn't exist, the 9210 will try to load a setup file named default.ssf. If no setup file exists, one must be created. See Chapter 3 for details. After creating the file, save it with the name that matches the station name (*station\_name.ssf* or default.ssf) to have it loaded at power up. Also, copy it to the PC so it can be used at other stations. Note: When a setup is loaded into the 9210, it will automatically create a log file if the setup calls for it.
50. Review the setup to make sure it is the correct setup for the station.
51. If using a Satlink select the Setup tab, press the + in front of Satlink, then:
52. Select Satlink and press Edit. Verify the transmission ID is correct. Verify the COM port is correct.
53. Select Satlink Self-Timed. Verify settings.
54. Select Satlink Random. Verify settings.
55. Select Self Timed Test
56. Verify the sample-formatted message.
57. Select Status.
58. Verify that the status from Satlink is displayed.
59. Verify that the GPS is being received.
60. If using a modem or other device, configure the COM section of the Setup tab, then:
61. Select COM from Setup tab and press EDIT.

62. Set appropriate COM port for the device type (E.G. Select "MODEM" on com 3). NOTE: SATLINK is configured under Satlink, so if a Satlink were connected to com2, leave com2 as "NONE" in COM section.
63. Select the + in front of COMS label.
64. Select appropriate COM port and press EDIT.
65. Configure the device. NOTE: Configure properties will automatically change based on settings from step b (E.G. selecting com3 would show MODEM configuration)
66. Once finished, press OK and the 9210 will configure each COM port.
67. If sensors are connected to the 9210, test them to make sure they are operating properly. Do this by following these steps:
68. Turn recording ON. This causes the system to fully activate the I/O modules.
69. Select the Sensors tab. This is a list of all configured sensors, the channel/module assignments and the last measured value.
70. Select each sensor and press the measure button. Verify that the new value displayed is correct.
71. If SDI-12 sensors are being used, press the SDI button if additional commands need sent to configure them or test their operation. NOTE: Recording will stop during this.
72. Before leaving a site, check to make sure Recording is ON.
73. Select the Log tab.
74. Select the desired log file and verify that the data is being stored as desired. EzSetup data is stored in SSP.log, graphical blocks are defined in the log block setup and may, or may not be stored into the SSP.log
75. Select the Status tab. Look for any errors that may be reported in the status box.
76. Finally, go to the MAIN tab and click LOG OUT.

## USING COM PORTS

---

### Overview

The 9210 has four RS232 COM ports. Com ports can be used for communications devices and serial sensors (with sensor specific setup blocks). The units are configured from the factory to provide +5 volts out on COM3 pin 9, this allows a Sutron 9210 Voice modem to be connected with one serial cable, to communicate and provide power, without the need to open the unit. Pin nine of all ports are user configurable for Ring In (RI), +5 Vdc out or +12 Vdc out (input power)

On the 9210 COM1 is a modified DCE (Female), COM 2, 3, and 4 are a DTE (Male). Com 1 has pins 1 and 9 modified as inputs, normal DCE use these pins as outputs.

DCE ports are connected to a PC using a M/F DB-9 straight-thru cable. The DTE ports can be wired to modems and Satlink using straight cables.

### Pin-out information

COM1 – Modified DCE Female

| DCE | Signal Name | Direction        |
|-----|-------------|------------------|
| 1   | CD          | IN<br>(modified) |
| 2   | RD          | OUT              |
| 3   | TX          | IN               |
| 4   | DTR         | IN               |
|     | GND         |                  |
|     | DSR         | OUT              |
|     | RTS         | IN               |
|     | CTS         | OUT              |
|     | RI          | IN<br>(modified) |

COM2 - 4 – DTE Male

| DTE | Signal Name | Direction |
|-----|-------------|-----------|
| 1   | CD          | IN        |
| 2   | RD          | IN        |
| 3   | TX          | OUT       |
| 4   | DTR         | OUT       |
| 5   | GND         |           |



|   |                                   |     |
|---|-----------------------------------|-----|
| 6 | DSR                               | IN  |
| 7 | RTS                               | OUT |
| 8 | CTS                               | IN  |
| 9 | Set by jumpers to RI, +5V or +12V |     |

## Jumper Settings

The following table gives the jumper settings and their default settings. To change the default settings, open the Xlite and change these jumpers:

|                                 | COM1    | COM2    | COM3         | COM4    |
|---------------------------------|---------|---------|--------------|---------|
| Configuration Jumper connector  | J800    | J900    | J901         | J1000   |
| Default configuration for Pin 9 | Ring in | Ring in | +5V Switched | Ring in |

## Configuration Jumpers

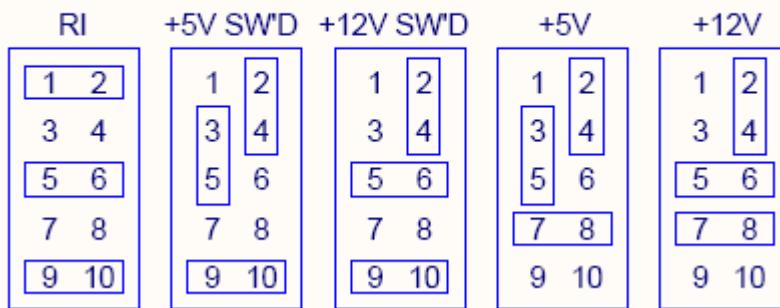

In the switched configuration, power is turned on when the port is opened, and turned off when the port is closed.



# **Chapter 8: Maintenance and Troubleshooting**

## COMMON MAINTENANCE AND TROUBLESHOOTING

---

### Skip autoexec.bat

If a unit does not appear to be running the 9210 app (blank screen) or communicating with a PC, then it is possible that the autoexec.bat file has become corrupted or modified incorrectly. Follow these steps to skip the autoexec.bat file:

Connect a PC running a terminal program to COM1 and apply power to the unit. After the terminal displays "Press Ctrl-C to skip execution of Autoexec.bat:", press CTRL key and C <CTRL-C>, hold until message displays "Bypassing \flash disk\Autoexec.bat..."

Once the unit has finished booting, the autoexec.bat file may be retrieved from the unit, modified and then transferred back onto the unit. Re-apply power and let the unit execute the new autoexec.bat file to verify it is fixed.

### Unit missing functionality

After upgrading a unit, if the unit appears to be missing some functionality (missing tabs/missing menu items/etc.), it is possible the unit detected an incorrect version of dll/sll and did not load it.

If this happens, a warning message is shown on boot-up and a warning message will be placed into the system log indicating what version was found and what is expected. If this happens, simply copy the correct version of dll/sll onto the flash disk and re-boot the unit.

### Xterm has a White screen or Black Screen

When using Xterm to talk with a 9210, if the screen area does not show the login prompt or menus:

Black screen- This indicates the unit is not communicating. Check that the unit has power and that the serial cable is connected. Also check that the correct com port and baud rates have been selected.

White screen- This indicates that Xterm is communicating with the 9210, but no program is running. First try right-clicking into the screen area to ensure the screen is updated. Check that the unit has an autoexec.bat by using file transfer, if it doesn't, send one to the unit (either create one following APPENDIX F or get it from the web site) and reboot it. If it does have one, transfer it to the pc and edit it to make sure it has the line \flash disk\xpert.exe in it. If the unit has the autoexec.bat and it has the line to run the xpert.exe in it, then close xterm, run a terminal program (@ 115200,8,N,1) and reboot the 9210. You should see the very last line of bootup information showing:

```
Launch complete.
```

If you do not see this, or get any other errors, contact customer service for further assistance.

### Adjust the contrast

To adjust the contrast on the Xlite, press SELECT and while holding SELECT use the RIGHT button to increase the contrast or LEFT to decrease the contrast. The contrast setting is

remembered by the display so it is not normally necessary to set the contrast each time you use the Xlite.

## **Replace the Internal Battery every 5 years**

**DISCONNECT POWER** before opening the unit.

The 9210 has an internal lithium battery to keep the clock running when power is removed. This battery should be replaced every 5 years as a preventative measure. Typically, on a unit that is sitting on the shelf with no power applied, the battery will last for 9 years. The 5 year recommendation is intended to provide a margin for the worst case situations. The battery is a 3 Volt, BR2330 type coin cell. Note, you will need to set the time after replacing the battery.

Upon power-up, the RTC date and time validity are checked. If determined to be invalid, the unit will set the date to 1/1/1984. A unit that sets its date to 1984 needs to have its internal battery checked and most likely replaced.

To replace the battery in the Xlite, remove the four screws holding the end panel (the one with the DB9s) to the extrusion. Slide the end panel away from the extrusion taking with it the top panel and circuit boards. Remove the top panel from the end panel by removing the two nuts holding the DB9 to the panel. Use a small screwdriver to help lift the battery out of the holder. Then slide the new battery into the holder.

## **Cleaning Instructions**

The 9210 can be cleaned using common mild window cleaning products. Do not spray the cleaner directly on the 9210. Instead, spray the cleaner on to a clean cloth and then wipe the case clean. Never spray cleaner directly on the terminal strips or on the wiring.

## **Fuses**

There are no replaceable fuses in the 9210. The 9210 does use a number of self-resetting fuses to help protect the unit from damage when lines coming from the 9210 are shorted. You may optionally use a fuse in the cable you connect to provide the 9210 with power. This fuse should be rated for at least two amps.

# Appendix A: Setup Blocks

## INTRODUCTION

---

The power of the 9210 is in its setup blocks. These blocks do the work of measuring, processing, logging and telemetry. Sutron will regularly develop new setup blocks to provide an expanding support for new sensors and updated processing. Customers will also be able to create setup blocks using optional software available from Sutron.

Following is a list of setup blocks that are provided with the system. The blocks are grouped as sensor blocks, processing blocks, log blocks, telemetry blocks, control blocks and miscellaneous blocks.

If additional AIO modules are added on to the 9210, then whenever VREF or AGND is referenced on the connection drawing, it is always referring to the VREF or AGND connection of the AIO module that is performing the analog measurement.

# SENSOR BLOCKS

---



## Air Temperature Sensor (AirTemp)

### Inputs

<none>

### Outputs

AirTemp

### Wiring

Connect the thermistor as shown below. The sensor needs a completion resistor (Rx) connected between the input and Vref, 10K is used in the example below, other values around 10K may be supplied. The input channel is Vi.

NOTE: DO NOT USE CHANNELS ABOVE 8 FOR EXCITATION.

### Description

This block supports temperature sensors based on the YSI44006, YSI44032, YSI44005 and YSI44036 thermistor. The AirTemp block makes a resistance measurement of the temperature and then converts the resistance to temperature. Choose the Analog I/O Module number, the analog channel (input) the sensor is hooked to, and the units this block should output the temperature in.

The following table shows the thermistor used by the different Sutron sensors:

| Sutron Sensor | Thermistor |
|---------------|------------|
| 5600-0010     | Linear*    |
| 5600-0011     | 44032      |
| 5600-0020     | Linear*    |
| 5600-0025     | 44036      |
| 5600-0030     | 44036      |

NON LINEAR

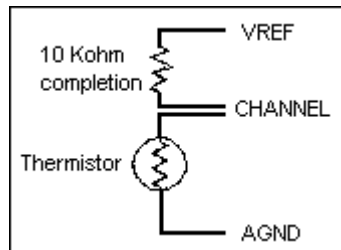
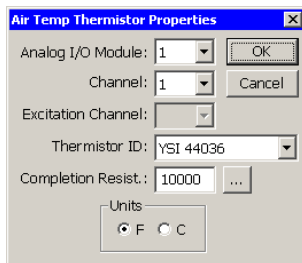

**Note: The 5600-0011, 5600-0025, and the 5600-0030 are all supplied with a precision completion resistor. The Completion Resist. box should be filled in with the value of the supplied resistor (10400 or 29400 depending on the sensor).**



\* When this air temp block is used with linear sensors, a double voltage measurement is made. If desired, a linear sensor can also be measured by the voltage block and appropriate values for slope and offset. Also, note the needed addition of a wire from VREF into the excitation channel.

LINEAR

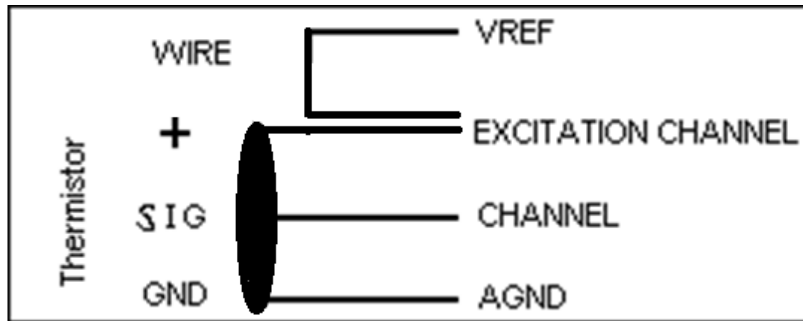



## Air Temperature/Relative Humidity (AT/RH)

### Inputs

<none>

### Outputs

TempOut

HumidOut

### Wiring

Wire each output to a separate analog channel

Power the sensor from the Battery or SW12 as selected in the setup.

### Description

This block supports the Sutron air temperature/relative humidity sensors 5600-0311, -12, -13, -14, the Rotronic HygroClip S3, and Vaisala HMP45, HMP155G (“active” model supporting -40 - +60), and HMP155J (“active” model supporting -80 - +60). Select the proper Analog I/O module, temperature channel, humidity channel and temperature units. If the sensor is hooked up to a constant power source (that is, either to the battery directly or the Batt terminal of the module) select *Batt* for power. If the sensor is hooked to the SwBatt terminal of the module so as to not draw current unless the sensor is begin sampled, select *SW Batt* for power. Specify the number of seconds the sensor should be powered before taking a measurement in Warm-up (s). To keep the block from ever outputting greater than 100 for humidity (corresponding to 100% relative humidity) check the box next to *Limit Humidity*.

AT/RH 5600 Properties

AIO Module: 1 Power: Batt

Temp Chan: 1 Type: 5600-0311

Hum Chan: 2 Warmup (s): 3 ...

Limit RH to 100%

Temp Units  
 Celsius  Fahrenheit

OK Cancel



## Analog (ADC)

### Inputs

<none>

### Outputs

AIOData

### Wiring

This section discusses the many different ways to use the ADC block from a wiring perspective.

#### *Excitation*

Many sensors are resistive or ratio metric in nature and need an excitation voltage. There is one programmable excitation output, Vex and multiple Vref outputs. The 2.5V reference, Vref, is always on during analog measurements and is the excitation that should normally be used. If there is a need for a reference voltage other than 2.5V, then the Vex excitation can be used by checking the “Excitation On” box and selecting the appropriate voltage. The excitation channel box specifies the analog input channel to which the excitation will be connected to allow the Xlite to measure the excitation.

NOTE: DO NOT USE CHANNELS ABOVE 8 FOR EXCITATION

#### *Voltage – Single Ended*

Connect the sensor’s Vout to any analog channel CH1.. CH10.

#### *Voltage – Differential*

Connect the sensor’s V+, V- to any pair of analog Channels CH1/CH2, CH3/CH4 through CH9/CH10. The channel being measured is the positive connection meaning that to measure CH2 with respect to CH1 (CH1 being the V- connection) select 2 for the Chan and be sure to check the Differential box.

#### *Current 4-20 ma*

Connect the sensor to +12 SW and the selected input channel. Add a 20-ohm completion resistor. Note, you can increase the accuracy (minimize errors introduced through the leads and connections) by using a 100 or 120-ohm completion resistor. However, if you do, you will need to enter the correct resistor value in the “resistance” field (available by deselecting the 8080-0003 block). NOTE: An alternative measurement technique would be to use a higher value resistor and make a VOLTAGE SINGLE ENDED type measurement (instead of 4-20mA), which is how the measurement was performed with the 8210 data logger. Just convert the resulting voltage into a measurement of the current output and take into account the low and high end of the sensor output. E.G. A 4-20 mA sensor using a 249.9-ohm resistor would develop about a 1 to 5 V dc output.

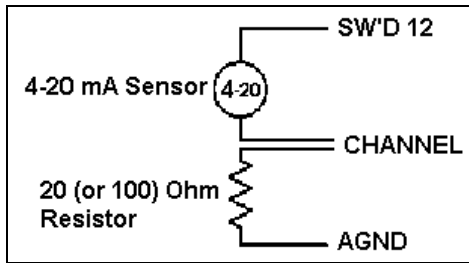

### DC Resistance

Resistance measurements always require excitation on and a selection for the excitation voltage. The excitation channel may be different from the measurement channel for three and four wire measurements. You may need to use a precision completion resistor connected as shown. Note, you can increase the accuracy by using a 100 or 120-ohm completion resistor. However, if you do, you will need to multiply the result by 5 for 100 ohm or 6 for 120 ohm to compensate for the increase in resistance.

### DC Resistance – 2 wire

Set the excitation channel to match the input channel.

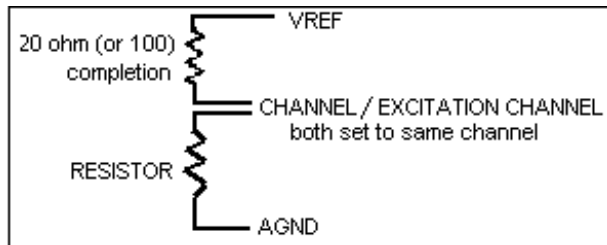

### DC Resistance – 3 wire

Set excitation channel to be different from input channel. Use a precision 20-ohm resistor (or 100 and divide reading by 5).

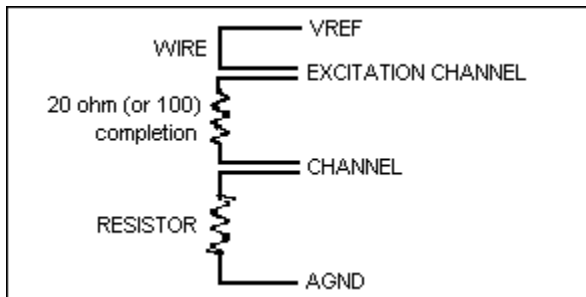

### DC Resistance – 4 wire

Select differential measurement. Set excitation channel to be different from input channel.

Connect the sensor as shown below. Select an odd number channel (1,3,...9) and an odd number excitation channel (1,3,...7). The even number pair is the next higher number, so in the example below, if the channel -selected is 1, then the EVEN # channel + is 2. The same thing applies for

the excitation channel, if the excitation channel - selected is 3, then the EVEN # excitation channel + is 4.

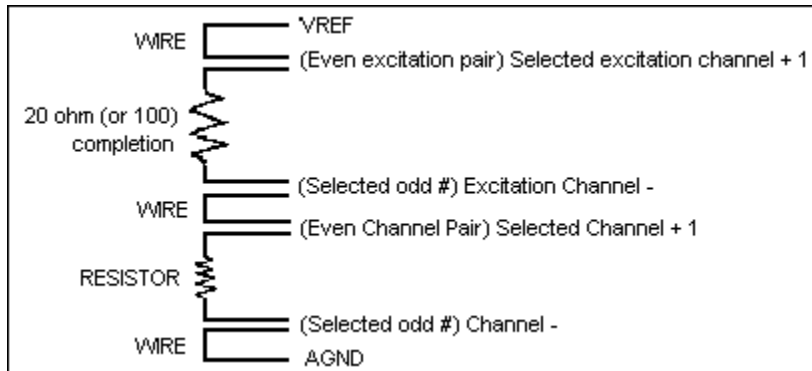

### ***AC Resistance – 2 wire***

Set excitation channel to match input channel. See connection information for DC Resistance.

### ***AC Resistance – 3 wire***

Set excitation channel to be different from input channel. See connection information for 3 wire DC Resistance.

### ***AC Resistance – 4 wire***

Set excitation channel to be different from input channel. Select differential measurement. See connection information for 4 wire DC Resistance.

### ***Thermistor – 2 or 3 wire***

The difference between the two wire and the three wire thermistor measurement is whether the thermistor probe includes a completion resistor and therefore has three wires, or whether the user needs to provide the completion resistor at the 9210 terminal block when connecting the two leaded sensor. Accuracy of the resistance measurement of the thermistor is directly related to the tolerance and temperature stability of the completion resistor. Output of the block is the thermistor resistance in ohms with the assumption that the completion resistor is exactly 10,000 ohms. If the thermistor is one supported by the Air Temperature block, then use of AirTemp block instead of this one will allow the output to be in terms of temperature.

Set excitation channel to be different from input channel. Connect the thermistor (or any resistance device) as follows. (Not applicable to an external 8080-0003 AIO module).

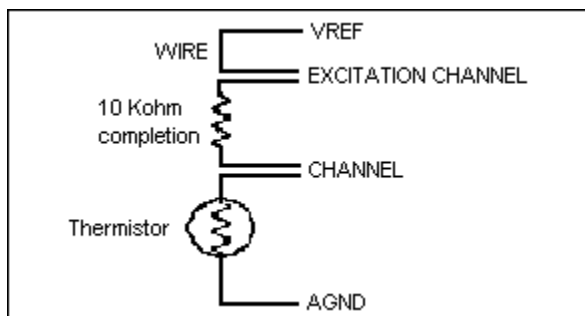

### ***Thermistor – 4 wire***

Select differential measurement, set the excitation channel to be different from the input channel.

Connect the sensor as shown below. Select an odd number channel (1,3,...9) and an odd number excitation channel (1,3,...7).

The even number pair is the next higher number, so in the example below, if the channel - selected is 1, then the EVEN # channel + is 2.

The same thing applies for the excitation channel, if the excitation channel - selected is 3, then the EVEN # excitation channel + is 4.

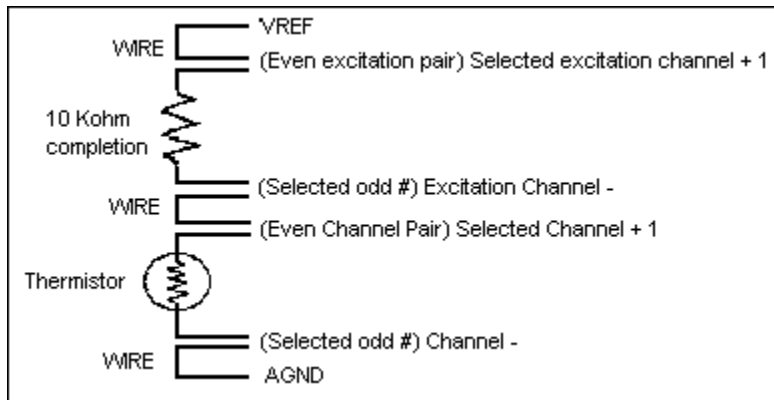

### ***DoubleVolts***

Set the excitation channel to be different from input channel.

DoubleVolts is intended for making ratio-metric measurements for a potentiometer and other similar ratio metric devices. The output value is the ratio of the input voltage/excitation voltage. Since both voltages are measured, the measurement is called DoubleVolts and the exact value of the excitation is not needed, measurements should be between 0 and 1 (Agnd or full-scale).

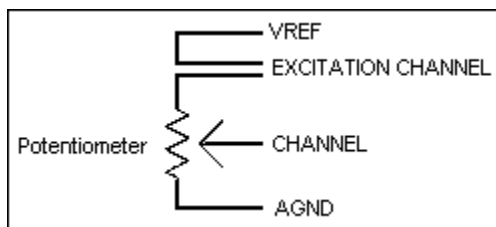

### **Description**

The Analog block is a general-purpose setup block for making voltage, current, resistance, or thermistor resistance measurements from an Analog I/O Module. One analog input can be setup with each Analog block. Reading the information on the Analog I/O Module in Appendix C: I/O Modules will help with the understanding of this powerful block.

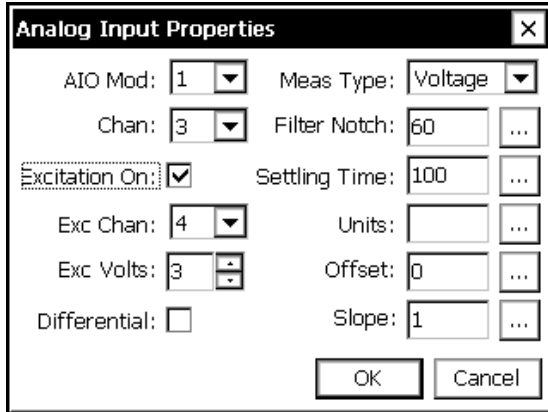

The block scales the outputs according to the values of *Slope* and *Offset* using the equation  $output = reading * slope + offset$ .

The user can change the units for all the outputs by changing the *Units* field to the desired value.

The block supports calibration from the Sensors tab and the Xlite front panel display. For the calibration, the user will enter the current value sensor. The system will then adjust the offset so the desired value is obtained.

To setup a sensor with the Analog block, first select the Analog I/O module to use. Then select what is to be measured under *Measurement*:

**Voltage:** This is for performing standard analog voltage measurements, similar to what could be done with the Voltmeter block. It requires one input channel for a single-ended measurement or an input channel pair for a differential measurement.

**Current (4-20mA):** This is for making current measurements in the range of 0 to 20ma. It requires one input channel for a single-ended measurement or an input channel pair for a differential measurement. The dialog changes slightly when this measurement type is selected:

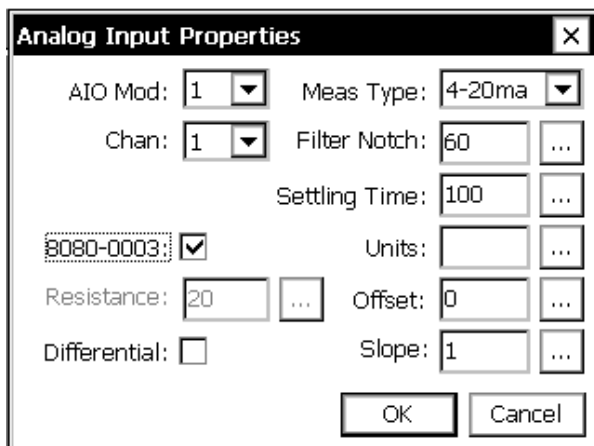

When measuring using an Xpert AIO module, make sure “8080-0003” is checked. Otherwise, specify the resistor value in “Resistance”.

**DC resistance:** To measure resistance, set-up an excitation channel and hook the device or medium to be measured between this channel and ground. The I/O module will do a voltage over current calculation to determine the resistance. The excitation voltage should be set to a value appropriate to the approximate resistance being measured. DC resistance uses a built-in precision 20-ohm resistor as the reference for the resistance measurement. An external 20-ohm bridge completion resistor must be used.

**AC resistance:** If this is selected, the I/O module will take two measurements for every measurement value the block outputs. The first measurement is done using the voltage specified by the excitation voltage and the second with this voltage negated. This can be used in cases where applying a DC excitation voltage would cause undesirable changes to the medium being measured. (An external 20-ohm bridge completion resistor must be used. In some cases, a 100-ohm resistor will provide greater accuracy).

**Thermistor:** This is a specialized resistance measurement geared for thermistors. An external 10K ohm bridge completion resistor is expected to be used. The accuracy of the reading is directly dependent on the tolerance and stability of the completion resistor utilized. For example, a 0.1% error in the completion resistor at room temperature can produce a 0.02C error in the temperature reading of a typical 10K thermistor. (If using an external 8080-0003 analog module, a stable and highly accurate 10K internal resistor is used and the excitation channel voltage is overridden to be 5V). This reading produces the thermistor's resistance. If the desired result is temperature, then review the Air Temperature Block to see if it supports the thermistor being measured.

**Volts HiGain:** When you select the "Volts HiGain" measurement type, a voltage measurement is made using hi gain. The maximum input voltage is 78mV when measuring using either the onboard Analog IO module, or when using the 8080-0007 Analog IO module. The maximum input voltage is 312mV when using the 8080-0003 Analog IO module.

**Volts x128:** When you select the "Volts x128" measurement type, a voltage measurement is made using very high gain. The maximum input voltage is 19mV when measuring using either the onboard Analog IO module, or when using the 8080-0007 Analog IO module. The maximum input voltage is 39mV when using the 8080-0003 Analog IO module.

Differential measurements can be made for each of the above *Measurement* choices. If you specify a differential measurement, be sure to select only channels 1, 3, 5, 7 or 9.

To enable an excitation channel click *Excitation On* and then select the channel number to use and the voltage level to output. Xlite will read an excitation on the selected channel (Run a jumper wire from either Vref or Vex to the selected excitation channel) NOTE: DO NOT USE CHANNELS ABOVE 8 FOR EXCITATION

**Filter notch:** This is a built in noise filter, the defaults of 60 should work for many measurements. If AC line noise becomes an issue, lowering this value will help reduce the noise. Lowering this value will also make measurements take longer.

**Settling Time:** This is the amount of time in milliseconds to leave the A/D (circuitry, switched 12Volts and VREF to sensors) powered before taking measurements. Sensors requiring a longer settling time, also called warm-up time, should have this value increased. Range for using the switched 12 volts is 0 to 60000 mSec (60 seconds) for Xlite aio, and 0 to 30000 (30 seconds) for external AIO module.



## BP Barometric Pressure (BP)

### Inputs

<none>

### Outputs

BP

Temp

### Wiring

Connect the sensor to the SDI-12 port.

### Description

This block supports the Sutron Accubar Barometer, part #5600-0120. This is an SDI-12 sensor. Select the pressure units, the SDI-12 address of the sensor and the averaging time (averaging time is used to increase the measurement accuracy by lengthening the sampling time). This block can also return temperature by clicking the box next to *Enable Temperature* and selecting the desired temperature units.

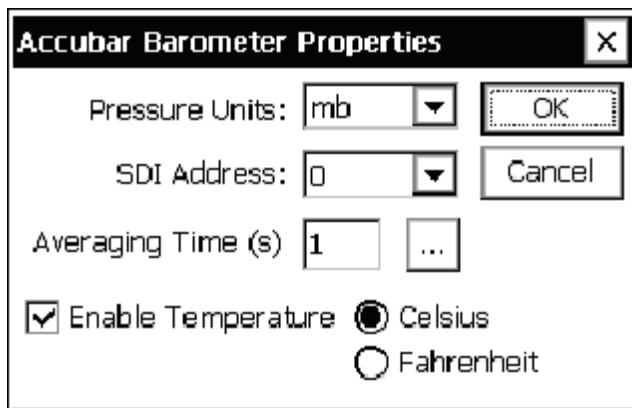

## BEI Absolute Encoder (BEIEnc)

### Inputs

<none>

### Outputs

Output

### Wiring

Connect the sensor to a RS232 port as follows (wiring is shown for the 6461-1239 protection board:

| Color     | Name | Pin<br>(6461-1239) |
|-----------|------|--------------------|
| Red       | +12  | 6                  |
| White     | RXD  | 2                  |
| Blue      | TXD  | 3                  |
| Green     | DTR  | 1                  |
| BLK/Brown | GND  | 5                  |

Note: (jumper J3 on the 6461-1239 to DTR)

Also, make sure to configure 9210 for +12 on pin 9 of the DB9.

Also, note that the encoder must be set to 4800, N, 8, 1.

### Description

This block supports the BEI Absolute shaft encoder. This encoder connects to any of the 9210 RS232 ports. See the section *Wiring* for the details of the connections. There are three user set properties for the BEI Encoder: Com Port, Range and Offset. Use Com Port to specify which RS232 port the encoder is connected to. **NOTE:** Leave the settings in the SETUP TAB/ COMS (SSP/CL) set to none, as this block will not be able to use the com port if Coms (SSP/CL) is already using it.

Range and Offset are used to scale the reading to the proper units. The equation used is:

$$\text{Output} = \text{Reading} * \text{Range} + \text{Offset}$$

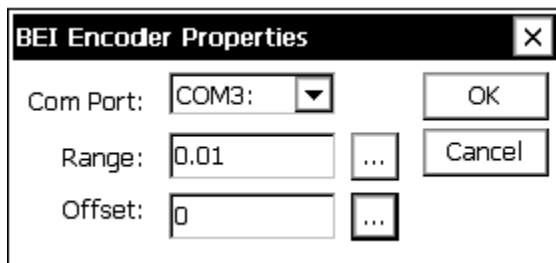

## Binary Input (BinIn)

### Inputs

<none>

### Outputs

BinOut

### Wiring

Signal: Any digital input channel (except for IN HF 1, which has a divide-by-8 circuit and will not properly read the input. If using channels 7 or 8, an external pull-up resistor to +5V (prot +12 will also work) is needed.

Ground: Any available ground

### Description

This is a general-purpose block for configuring a binary input hooked to a Digital I/O module. *Channel* is one of the eight inputs available on the module (see Appendix C: I/O Modules).

A processing block such as Measure or Average is used to request data of this block, unless *Event* is checked. With *Event* checked, the output will update on change of state. Use “Edge” to determine which edge of the state change to trigger (Rising = Low → High, Falling = High → Low, Both = either direction).

The Filter parameter can be used to eliminate false state transition detections due to noise. The Filter value should be a number between 0 and 255. The higher the number, the longer the new state change must exist for the change to be seen by the digital I/O module. Each increment of the filter value represents about 0.5ms of time.

If this block is used in an EZSetup measurement with the *Event* checked, this will force ALL measurements to occur when an *Event* occurs. So, for example, if you had an EZSetup measurement schedule with the BinIn block and a sdi-12 sensor, every time the BinIn detected a change of state, the SDI-12 sensor would also be measured.

If *Invert* is checked, the output from this block will be the inverted value of what is seen at the channel (e.g., if the input is grounded, a binary 1 is output instead of a binary 0).

Input states are:

0V = binary 0

>2.5V = binary 1

**Binary Input Properties** [X]

Digital I/O Module: 1 [v] [OK]

Channel: 2 [v] [Cancel]

Invert Input

Event

Edge: Both [v]

Filter value: 0 [ ] [ ... ]



## Binary Input – All Channels (BinInAllChan)

### Inputs

<none>

### Outputs

DIOData

### Wiring

Signal: wire to all input channels defined in Bit Selection. **Note: do not wire to IN HF 1.** This channel has a divide-by-8 circuit and will not properly read the input. Channels 1 – 6 have 100k internal pull-up resistors. Therefore, if open collector outputs are connected to channels 7 or 8, use an external pull-up resistor to +5V (prot +12 will also work).

Ground: any available ground

### Description

This block reads all bits defined in Bit Selection from a Digital I/O module and outputs the binary or gray code value the data represents. The block allows the user to select the I/O module, the number of bits, the coding, and whether or not the data needs to be inverted.

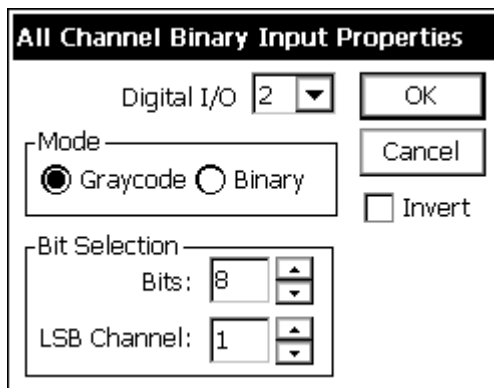

The coding options available are Binary and Greycode. Binary reads the input channels as binary bits, which it then converts to decimal (e.g., LLLL HLHL = 0000 1010b = 10d). Greycode is a coding scheme where each sequential value only differs from its predecessor by one place. It is often used by absolute encoders so that slight misalignments between the reading elements will not result in widely incorrect readings. Notice, for example, that an increase from 3 to 4 causes two bits to change in binary but only one in Greycode:

| Decimal | Binary | Greycode |
|---------|--------|----------|
| 0       | 000    | 000      |
| 1       | 001    | 001      |
| 2       | 010    | 011      |
| 3       | 011    | 010      |
| 4       | 100    | 110      |
| 5       | 101    | 111      |
| 6       | 110    | 101      |
| 7       | 111    | 100      |

The Bits value defines how many bits to convert, from six to eight. If less than eight bits are being converted, then set LSB Channel to the channel of the least significant bit.



## Bridge Resistance (Bridge)

### Inputs

<none>

### Outputs

Output

### Wiring

Wire to the 9210 as shown below.

NOTE: DO NOT USE CHANNELS ABOVE 8 FOR EXCITATION

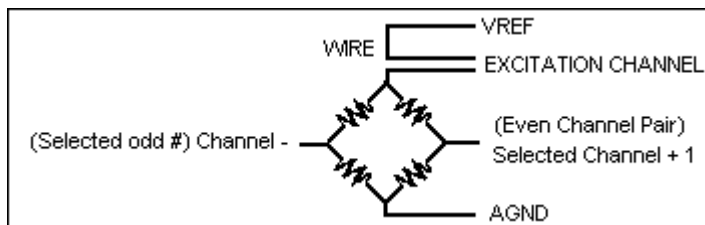

### Description

This block reads a bridge type resistance sensor. These sensors typically require an excitation of 2 to 5 volts and a full-scale output of 10 to 100 mV. To make this measurement, the 9210 makes a single ended measurement of the reference voltage and a differential measurement of the input voltage. The equation applied to the measured voltages is as follows:

$$\text{Output} = \text{Slope} * V_i/V_x + \text{Offset}.$$

The user set properties of the Bridge block are shown below. Note that the input is a differential measurement so select an odd numbered input channel:

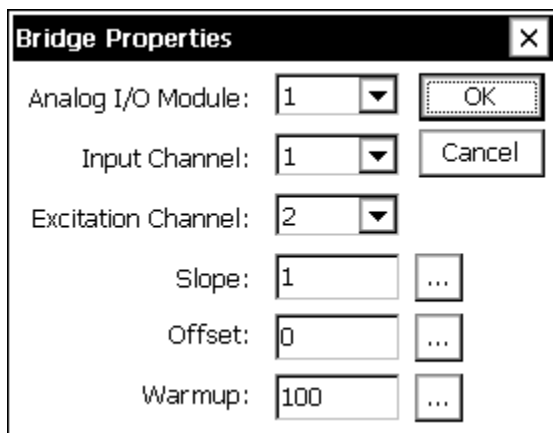



## CapRain (CapRain)

### Inputs

<none>

### Outputs

Rain

### Wiring

Connect the sensor output to the selected analog channel.

Connect the sensor power to PROT 12 (B17) and GND (B16 or =)

### Description

The CapRain block is designed to make measurements from an RM Young 50202 Capacitive Precipitation Gauge. It may also work with other rain gauges with an analog output. The RM Young 50202 sensor has an analog output (0-5 volts) corresponding to 0-50mm (0 to 2.5 inches) rain. The sensor automatically empties itself so the output will periodically go to zero.

The CapRain block has special processing designed to prevent measurements while the gauge is emptying the bucket. This processing takes two measurements of the gauge two seconds apart. If the output drops by more than 0.1 volts in this two-second interval the system sleeps for 5 seconds and then tries again. Up to six retries will be performed before the system logs an error. The block also has a special algorithm to accumulate the rain as though the bucket were not being emptied. If the current value measured has gone down by 1/5 of the range since the last measured value the software concludes that the gauge has emptied and adds 5\*slope to the sensor offset. The value reported by the block is always reading + offset.

Note: You must get data from the CapRain block every 10 to 15 minutes so it can track the emptying. The maximum rain rate that can be handled by measurements every 10 minutes is 12 inches/hour and the maximum rate handled by measurements every 15 minutes is 8 inches/hour.

The block supports the calibration to a use entered current value. When the calibration function is run, the system prompts for the current level. It then uses the current level and the current reading to automatically set the offset. The calibration function should not be done when the system is emptying the gauge or while the gauge output is changing.

Enter the slope in the units that you desire. The slope for inches would be  $0.5 = 2.5\text{inches}/5\text{volts}$ . The slope for mm would be  $10 = 50\text{mm}/5$ .

The offset should normally be 0 for a new site with an empty gauge. As explained above, the offset can also be computed to force the gauge to a specific value.

The units should be set to in or mm as determined by the slope.



CapRain Properties

Analog I/O Module: 1

Input Channel: 7

Slope: 0.5

Offset: 0

Units: in



## Constant (ConstIn)

### Inputs

<none>

### Outputs

Const

### Wiring

None

### Description

The constant block provides a constant value output. This can be valuable for testing setup diagrams before physical sensors are hooked-up, or in any other situation where a constant output is needed. A constant value may be modified via calibration or by setting the value of a connected ComsTag block using telemetry, the command line SET command, or the Data tab. This allows a constant block to be used for manual readings and other purposes. Modified values are stored back in to the setup file.

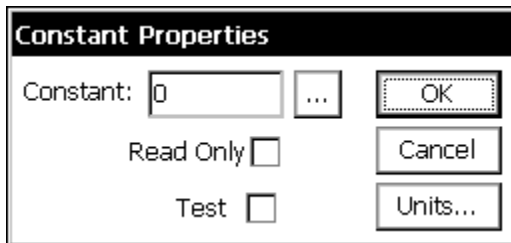

The *Read Only* check box may be used to prevent the constant value from being modified by means other than direct modification of the setup.

The *Test* check box is used to generate data that varies. This can be useful for system tests. When *Test* is checked the data will vary as follows:

| Constant | Output  |
|----------|---|
| 1        | TickCount (ticks have units of milliseconds, not synchronized to any particular time) |
| 2        | Random Number between 1 and 32767   |
| 3        | Output increases by 1   |
| 4        | Output increases by 1 and delay 500 ms  |

The Units... button may be used to define the units for the constant value:

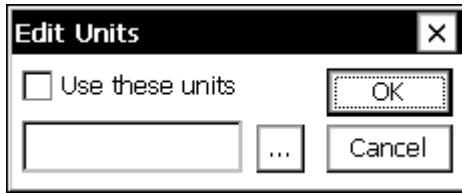

If *Use these units* is checked then the text entered below it is used as the units for the constant block, otherwise the units are passed on to the next block as blank.

## Counter (Counter)

### Inputs

<none>

### Outputs

Count

DeltaCount

Freq

### Wiring

Connect the device to the selected digital input.

NOTE: Channel 1 has a divide-by-eight circuit for higher frequencies. Xlite has this calculation built-in and will show the correct frequency without any additional math. Do not use channel one to get a count or delta count as it will only update every eight counts.

### Description

The Counter block is a general-purpose block for measuring a counter or frequency input. Each time the block is run, it collects counter information from the digital I/O module and then computes a delta count and frequency from the data collected the last time the block was run. As a result, the first time this block is run, the frequency and delta count output will not have valid data.

Filter is used to debounce noisy inputs. Most mechanical switches, like a tipping bucket output, have noise, so a filter should be used with switches. A value of 0 specifies no debouncing while a value of 1 to 255 requires the input to remain high for  $\text{filter\_value} \times 0.2$  ms in order for the system to register a count.

Along with computing the deltacounts and frequency, the block also scales the outputs according to the values of *Slope* and *Offset*.

The units for the outputs are forced to be Hz for Freq and CNT for Count and DeltaCount whenever the units are set to Hz. The user can change the units for all the outputs by changing the *Units* field on the property page to the desired value.

When *Reset Count* is checked, the count resets every time recording is started. If the counter has been calibrated, it will reset to the calibrated value, otherwise, it will reset to zero. If more than one counter block, or tipping bucket block, is used on the same input channel, all blocks would be reset to zero.

The Counter block does support Calibration from the Sensors tab and front panel. For the calibration, the user will enter the current value for the counter. The system will then compute a special calibration offset that is applied to the counter.

Anytime recording is stopped and restarted, the counter should be calibrated to a known state, as any counts that have occurred during the time when recording was stopped, have been missed.

**Counter Properties** [X]

Digital Mod: 1 [v] [OK]

Digital Chan: 2 [v] [Cancel]

Filter: 5 [ ] ...

Slope: 1 [ ] ...

Offset: 0 [ ] ...

Units: Hz [ ] ...

Reset count:



## CS107 Temperature Sensor (CS107Temp)

### Inputs

<none>

### Outputs

Temp

### Wiring

Connect the Thermistor black wire to the selected signal channel of the analog module CH1..CHxx

Connect a precision 100K 0.1% resistor between CHx above and the selected excitation channel CH1..CH8. NOTE: DO NOT USE CHANNELS ABOVE 8 FOR EXCITATION

Connect a wire between Vref and the selected excitation channel.

Connect the Thermistor red to GND

Do not connect the purple AG to anything. Keep it insulated so it will not contact anything.

Connect the clear shield to GND.

### Description

This block measures a CS 107 temperature probe. The CS 107 uses a thermistor to measure temperature in air/soil or water over the range of -35 to +50C with an accuracy of about 0.5C.

The 9210 measures the CS107 using its special double voltage reading where it measures its excitation voltage in addition to the signal voltage. The nominal excitation voltage is 5 volts.

After making the measurement, the temperature is computed as follows:

$$R = VM*100000./(VX-VM)$$

Where R is the resistance of the thermistor, VM is the measured excitation voltage and VX is the measured signal voltage.

$X = 800000/(R)$  (this converts the resistance to a format compatible with the published conversion polynomial.

$$\text{Temp} = a + b*X + c*X^2 + d*X^3 + e*X^4 + f*X^5$$

Where:

Temp = temperature in degrees Celsius

$$a = -53.4601; b = 90.807; c = -83.257; d = 52.283; e = -16.723; f = 2.211$$

CS 107 Temperature ✕

Analog I/O: 1 OK

Excit. Chan: 1 Cancel

Meas Chan: 2

Units:  F  C



## Frequency (Freq)

### Inputs

<none>

### Outputs

Freq

### Wiring

Connect the sensor frequency output to the selected CH1..CH8 of the digital module.

Connect the sensor GND to GND.

### Description

This block outputs the frequency of a digital input signal. First, select the Digital I/O Module and the channel number. Note that the Xlite channel 1 is capable of measuring frequencies up to 8 KHz. All other channels have a maximum frequency of 1KHz. The field *Multiplier* is normally left at one unless the cycles-per-second output of the frequency is to be changed. For example, to changing to cycles-per-minute, enter 0.0167 for this field.

The *Period* mostly has to do with when the block takes instantaneous (as opposed to continuous) frequency readings. For instantaneous readings, the Frequency block takes two time/count readings from the I/O module at *Period* time apart and used these to calculate the frequency of the signal. The longer the value entered for *Period* the greater the accuracy of the frequency (because of averaging) but the less “instantaneous” the reading will be.

When the frequency is being sampled frequently by a Measure or Average block, it might make sense to only take one time/count reading from the I/O module every pass, and calculate the frequency from the current and previous readings. For a sampling interval of 1 second, this would be the same as having the *Period* set to 1,000. If this is desired, un-check *Take Two Readings at a Time*, and set *Period* to 1,000. The 9210 will use the previous reading as long as it was taken within the time range of *Period* +/- *Period*/4 of the current time. Be careful how you set *Period* when *Take Two Readings* is unchecked. The smaller you make *Period*, the more likely the system will still take two measurements even though *Take Two Readings* is not checked. You should not make *Period* longer than the sampling interval of your measure or average block, or you will slow down data to the block. If you always want to use the previous reading to compute the frequency regardless of when it was measured, use the COUNTER block.

The block scales the outputs according to the values of *Slope* and *Offset* using the equation  $output = reading * slope + offset$ .

The user can change the units for all the outputs by changing the *Units* field to the desired value.

The block supports calibration from the Sensors page and the Xlite front panel display. For the calibration, the user will enter the current value sensor. The system will then adjust the offset so the desired value is obtained.



**Frequency Properties** [X]

|                  |                                     |         |        |       |       |
|------------------|-------------------------------------|---------|--------|-------|-------|
| DIO Mod:         | 1 [v]                               | Slope:  | 1      | [...] |       |
| Channel:         | 1 [v]                               | Offset: | 0      | [...] |       |
| Period (ms):     | 200                                 | [...]   | Units: | Hz    | [...] |
| Take 2 readings: | <input checked="" type="checkbox"/> |         |        |       |       |

[OK] [Cancel]



## Fuel Moisture (FM)

### Inputs

<none>

### Outputs

Fuel Moisture (FM)

### Wiring

Connect the FM signal ( to the selected input on the digital module (CH1)

Connect the FM enable to the selected input on the digital module (CH2)

Connect the GND to GND

Connect the FM Power to VBAT

Note: the digital module must have special code (part number 8080-0006-1).

### Description

This block measures a CS505 Fuel Moisture sensor. The sensor has an output frequency in the range of 600 to 1500 Hz. A special version of the digital module 8080-0006-1 is needed to read these higher frequencies. The sensor also has a separate enable line to turn on and off the sensor as needed to make a measurement.

The equation used to convert the frequency to fuel moisture (percent) is as follows:

$$PP = (1 / \text{Freq}) * 1000$$

$$FM = C0 + C1 * PP + C2 * PP * PP$$

$$C0 = -220.14$$

$$C1 = 365.89$$

$$C2 = -114.96$$

Fuel Moisture Properties

Digital I/O Module: 1

Channel: 1

Enable Channel: 2

OK

Cancel



## GetTag

### Inputs

### Outputs

Data

### Description

This block gets the requested data from another station using Sutron Standard Protocol (SSP) communications. The properties for the block specify the port to use for the communications and the path or station name. The port can be specified only if you have first set up ports in the Coms (SSP/CL) entry on the Setup tab. The path can be a simple station name, or a station with full path information included (such as `\patha\pathb\stationx`). When the Port selection is “TCP/IP”, enter the URL to the destination. The Tag property must match the name specified in a COMS Tag in the named station.

For example, Station 1 is measuring water level and Station 2 wants to get the water level for its own use. Add a COMS Tag after the measure of the water level in Station 1. Set the COMS TAG *Name* property as WaterLevel. In Station 2, add a GetTag block connected to a measure. In the GETTAG properties, set the *Tag* property to WaterLevel. Also set the port and path for the link between the two stations. Now, whenever the GetTag block runs, the code will communicate to the named station and ask for WaterLevel. The station will reply with the data for WaterLevel and then the GetTag block will provide the data to connected blocks.

The image shows a dialog box titled "Tag Properties" with a close button (X) in the top right corner. It contains three input fields: "Port:" with a dropdown menu showing "COM1:", "Path/URL:" with a text box containing "\*" and a browse button "...", and "Tag:" with a text box containing "WaterLevel" and a browse button "...". At the bottom, there are "OK" and "Cancel" buttons.



## GillWind (Gill Wind Sensor)

### Inputs

<none>

### Outputs

WindSpeed

WindDirection

### Wiring

Connect the sensor to a RS232 port as follows (wiring is shown for the 6461-1239 protection board):

| Connector   | Name | Pin<br>(6461-1239) |
|-------------|------|--------------------|
| 2 V+        | +12  | 6                  |
| 5 TXD       | RXD  | 2                  |
| 7 RXD       | TXD  | 3                  |
| 1 GND, 3 V- | GND  | 5                  |

Note: Set jumper J3 on the 6461-1239 to DTR

Configure 9210 for +12 on pin 9 of the DB9.

Gill sensor must be set up as follows:

M4, U3, O1, L1, P2, B3, F1, H1, HQ, E1, T1, S3, C1

### Description

This block supports the Gill WindSonic ultrasonic wind sensor. This sensor has an RS232 serial output that can connect to one of the 9210 serial ports. The WindSonic has its own configuration and setup. The user must make sure the WindObserverII is setup to operate with the 9210 before connecting it to the 9210. The 9210 will not alter the setup of the sensor.

In setting up the sensor, the user can choose the output units, heater control, and node address etc. The user must set the sensor block's "node address" property to the same address that the sensor has been configured to.

User must setup the sensor as follows (see the Gill manual for further details):

Establish a connection from the sensor to a PC and turn on power to the sensor.

Enter configuration mode by sending \* if the sensor is in continuous output mode, or sending \*<node> if the sensor is in polling mode.

Send D3<CR> to display the current configuration.

Set the sensors to the following parameters (the manual explains how to do this):

WindSonic: M4,O1,L1,P1,B3,F1,H2,E1.

Set the units as desired with U, the heating with H, and the node address with N.

Send Q<CR> (Q is for Quit) when finished.

The setup of the 9210 to read the WindSonic is much easier. Simply specify the com port the sensor is connected to, the power setting and the address. **NOTE:** Leave the settings in the SETUP TAB/ COMS (SSP/CL) set to none, as this block will not be able to use the com port if Coms (SSP/CL) is already using it.

The 9210 will output the data in whatever units are set in the WindSonic.

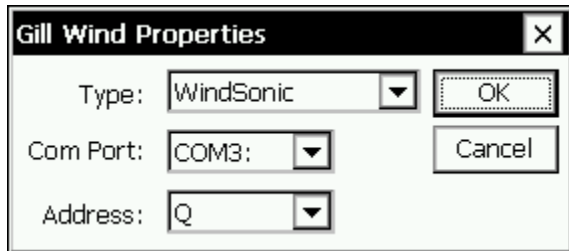



## Heat Flux (HeatFlux)

### Inputs

<none>

### Outputs

Heat Flux

Sensitivity

### Wiring

Two models of Hukesflux sensors are supported, HFP01 and HFP01SC. The latter model supports a periodic self-calibration procedure involving an onboard heating element.

#### *HFP01*

For single ended operation, connect the sensor's V+ to any analog input channel CH1.. CH10, and V- to AGND. For differential operation, connect V+ and V- to an adjacent input channel pair (e.g., 1 and 2, 3 and 4, etc.), and check the Differential checkbox.

#### *HFP01SC*

Connect as shown in the diagram, below.

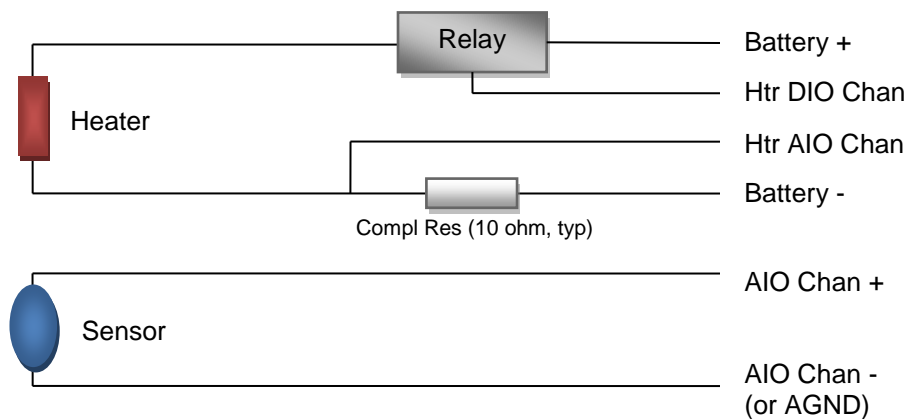

### Description

The HeatFlux block is used to measure heat flux via a Hukesflux HFP01 or HFP01SC heat flux sensor. The following dialog is used to configure the sensor for measurement:

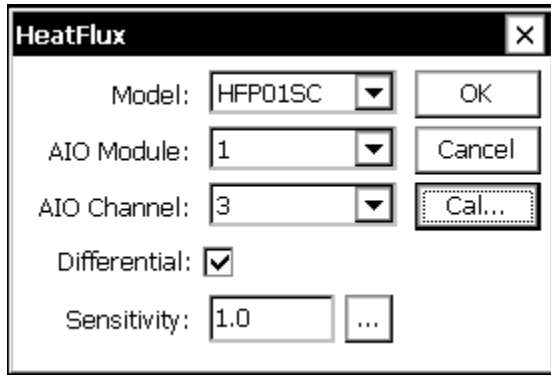

Select the type of heat flux sensor in Model, and specify the analog I/O module and channel in AIO Module and AIO Channel. Check the Differential checkbox, if the sensor has been wired for differential measurement. Enter Sensitivity from the manufacturer’s cal sheet.

**Calibration**

Press the “Cal...” button to configure model HFP01SC for calibration:

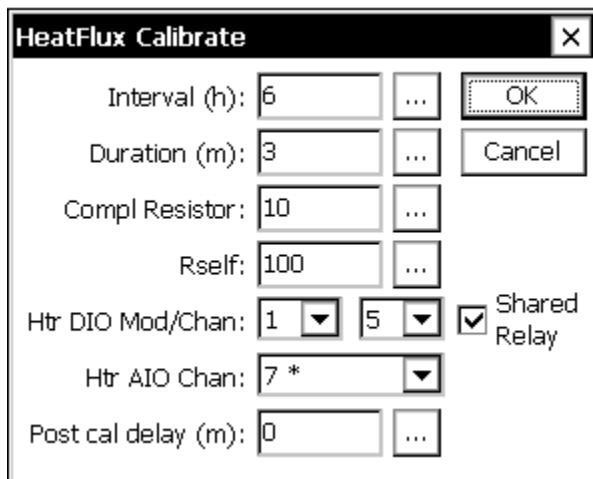

The calibration procedure involves periodically turning on a heating element to generate a known heat flux that can be measured to obtain a correction for measurements of unknown (environmental) heat fluxes.

Specify how often to perform a self-calibration in Interval (hours), and the length of the calibration in Duration (minutes).

Specify the value of the completion resistor in-line with the heater power supply (10 ohm, typically). Specify the Rself value provided by the manufacturer’s data sheet with the sensor.

Specify the digital I/O module and output channel used to control power to the heater in “Htr DIO Mod/Chan”.

Specify the analog input channel to which the resistor tap is connected in “Htr AIO Chan”.

Use “Post cal delay (m)” to specify the number of minutes to extend the calibration cool-down period.

When “Shared Relay” is checked, the system assumes the relay this HeatFlux block uses to control power to the heater is shared with other HeatFlux blocks. There may be only one shared relay. When “Shared Relay” is not checked, then the system assumes the relay for this block is not shared. Note: when sharing a relay, make sure the measurement schedules, and Interval and Duration properties, are set the same, for all HeatFlux blocks sharing the relay.





## Internal Battery (IntBat)

### Inputs

<none>

### Outputs

Battery

Temp

### Wiring

None, the sensor is internal to the 9210.

### Description

This block measures the 9210B supply voltage and internal temperature.

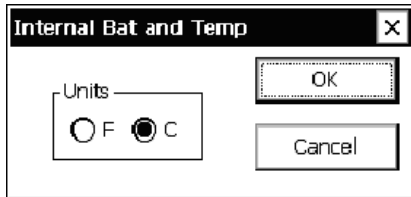



## Log Input

### Inputs

<none>

### Outputs

LogVal: the value retrieved from the log

### Wiring

None.

### Description

This block retrieves the last value from the log for the sensor indicated. This block is most useful when data is logged by EzSetup or an Xpert Basic program, but needs to be processed in the Graphical Setup. When scheduling this block, be sure to schedule it so that it runs *after* the desired data is logged.

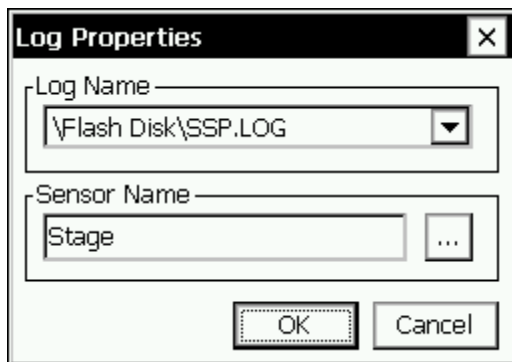



## ML2x Soil Moisture Sensor (ML2x)

### Inputs

<none>

### Outputs

Dielectric

Moisture

### Wiring

The sensor is measured single ended. Hence, connect the sensor's V+ to any analog input channel CH1.. CH10, and signal ground to AGND. Connect power as desired.

### Description

The ML2x block is used to measure a Delta T ML2x soil moisture sensor. The following dialog is used to configure the block for measurement:

The screenshot shows a configuration dialog box titled "ML2x". It contains the following fields and controls:

- AIO Module: 1 (dropdown menu)
- AIO Channel: 4 (dropdown menu)
- Cal Method: Mineral (dropdown menu)
- a0: 1.6 (text input field)
- a1: 8.4 (text input field)
- Units: % (text input field)
- Buttons: OK, Cancel

AIO Module: select the analog module to which you connected the sensor.

AIO Channel: select the channel to which the sensor's V+ signal is connected.

Cal Method, a1, and a0: Select the method to use for calibrating the sensor measurement to the actual soil type. The possible selections are *Mineral*, *Organic*, and *User Cal*. *Mineral* and *Organic* are generalized calibrations for those two classes of soils, where predefined values of a0 and a1 are used to calculate moisture content. *User Cal* allows you to enter your own values for a0 and a1 that you determine through a soil specific calibration procedure. See the ML2x manual for more information on how perform this procedure.

Units: enter the string that should be used when displaying Moisture units.



## MRL 700 Radar Sensor (MRL700)

### Inputs

<none>

### Outputs

dist

level

sigstr

### Wiring and Configuration

Connect the sensor to RS485 A to the 9210 RS485A and the sensor B to the 9210 RS485B (OPT COM4). **NOTE:** Leave the settings in the SETUP TAB/ COMS (SSP/CL) COM 4 set to None, as this block will not be able to use the com port if Coms (SSP/CL) is already using it.

The sensor must be configured to output in the following format: distance, signal strength with 9600 baud, 7bit, even parity, one stop bit. Configure the sensor to output 0.00 if it loses signal. For more information see the 8800-1146 MRL users manual.

Connect Power leads as configured below, either to GND and SW'D 12 (for AIO sw or DIO sw), or through a relay that is switching the battery and using the selected DIO channel for control.

### Description

The MRL700 is used for measuring distance and, therefore, level. The properties dialog is used to specify configuration details required for proper operation.

“Reference” is used to specify the reference distance and is used to compute level.

“Warmup” is the number of seconds the unit should be powered on before taking a measurement. A typical warmup value is 30 seconds, this is the time the sensor needs to provide back reliable readings. If the values are to be averaged, make sure to set the average time to at least two times this warmup time (E.G. For 30 seconds of warmup the sensor should be averaged for at least one minute)

“Inactivity” is the number of seconds the unit should remain powered on following a measurement. This prevents the sensor from having to go through the warmup time for every reading (E.G.. If averaging every 5 seconds, setting this inactivity timer to 10 seconds, will keep power on between readings).

“PwrCtl” is used to specify how the sensor is to be powered on. When set to “DIO Sw”, DIO switched-12 is used to control power. When set to “AIO Sw”, AIO switched-12 is used to control power to the sensor. (On the Xlite, of course, AIO and DIO switched-12 are the same thing). When set to “DIO Chan”, the module and channel fields are used to determine the digital output used to control power to the sensor.

“Module” and “Channel” are used to designate the IO module used to control power to the sensor (Channel is applicable only when PwrCtl is set to DIO Chan).

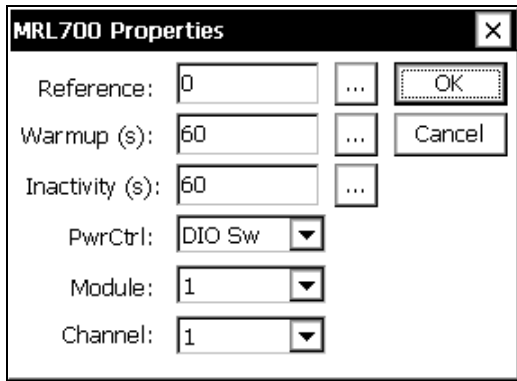

A typical averaging setup (using Ezsetup) would be as follows:

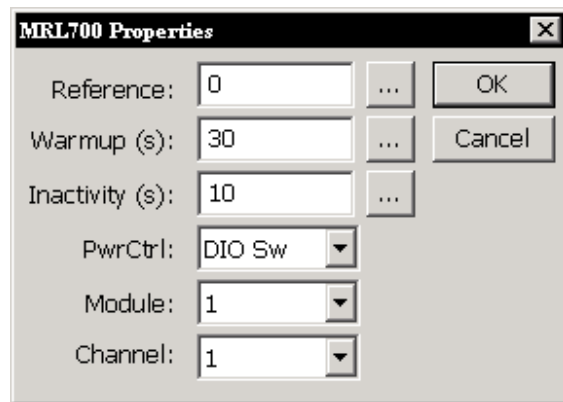
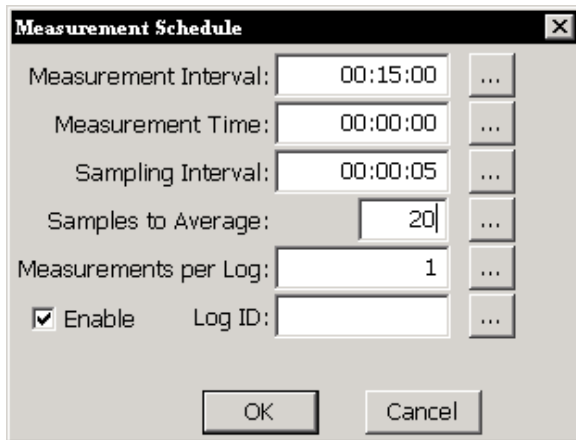

Using the measurement time starting at 00:00:00 and a 00:15:00 interval, will log the data with a timestamp at 00:01:35,00:16:35.....23:46:35.



## Net Radiometer Sensors (NetRad)

### Inputs

<none>

### Outputs

NetRad

ShortRad (Up)

ShortRadDown

LongRad (Up)

LongRadDown

### Wiring

Three sensor types are supported, and the wiring differs for each.

#### ***Kipp & Zonen NR Lite 2***

For single ended operation, connect the sensor's V+ to any analog input channel CH1.. CH10, and V- to AGND. For differential operation, connect V+ and V- to an adjacent input channel pair (e.g., 1 and 2, 3 and 4, etc.), and check the Differential checkbox.

#### ***Kipp & Zonen CNR 2***

For single ended operation, connect the two V+ signals to any two input channels CH1 .. CH10, and V- to AGND. For differential operation, connect NetWaveShort V+ and V- to an adjacent input channel pair, and connect NetWaveLong V+ and V- to an adjacent input channel pair (an "adjacent input channel pair" starts with an odd channel, e.g., 1 and 2, 3 and 4, etc.). Be sure to check the Differential checkbox.

#### ***Kipp & Zonen CNR 4***

For single ended operation, connect the four V+ signals to any four analog input channels CH1 .. CH10, and V- to AGND. For differential operation, connect Pyrano and Pyrgeo pairs to adjacent input channel pairs (an "adjacent input channel pair" starts with an odd channel, e.g., 1 and 2, 3 and 4, etc.). Be sure to check the Differential checkbox.

Connect the V+ and V- thermistor leads similarly (V+ to input channel and V- to AGND for single ended, V+ and V- to an adjacent input channel pair for differential).

Connect the heater and ventilator grounds to GND, and connect the heater and ventilator leads each to a digital channel output.

### Description

The NetRad block is used to measure one of three different net radiation sensors, the Kipp & Zonen NR Lite 2, CNR 2, and CNR 4. Each sensor differs in the components of radiation measured.

The NR Lite 2 is a high-output thermopile sensor that measures the sum of incoming and outgoing all-wave radiation (i.e., both short-wave and long-wave radiation). This sum is output via the NetRad block output. The other block outputs (ShortRad, LongRad, etc.), are ignored.

The CNR 2 also measures and outputs net total radiation in NetRad, but also measures and outputs net short-wave radiation in ShortRad and net long-wave radiation in LongRad.

The CNR 4 also measures and outputs net total radiation in NetRad, net short-wave radiation from above in ShortRadUp, net short-wave reflected radiation from below in ShortRadDown, net long-wave radiation from above in LongRadUp, and net reflected long-wave radiation from below in LongRadDown.

The following dialog is used to configure the sensor measurement:

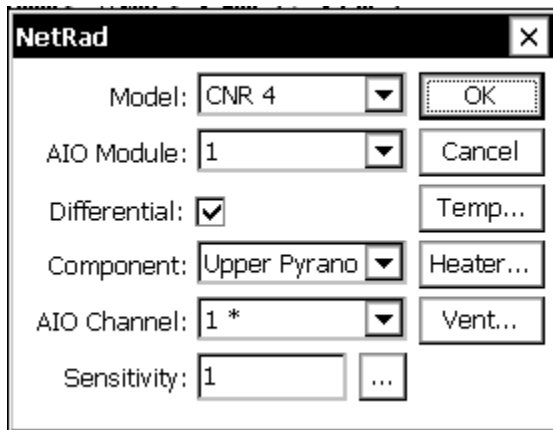

Model: Select the Model you wish to measure.

AIO Module: select the analog module to which you connected the sensor

Differential: check this box to measure the sensor input(s) differentially.

Component: when Model is either CNR 2 or CNR 4, use this drop-down to select which component to configure using AIO Channel and Sensitivity.

AIO Channel: the channel to which the sensor's V+ signal is connected. When Model is either CNR 2 or CNR 4, the channel applies to the selected Input.

Sensitivity: the sensitivity of the selected signal. When Model is either CNR 2 or CNR 4, the sensitivity applies to the selected Input.

### ***Temperature***

When CNR 4 is selected, configure the block to measure temperature by selecting the Temp button, and entering the AIO module and channel to which the temp signals have been connected. Also enter the value of the completion resistor in ohms you used when wiring the thermistor.

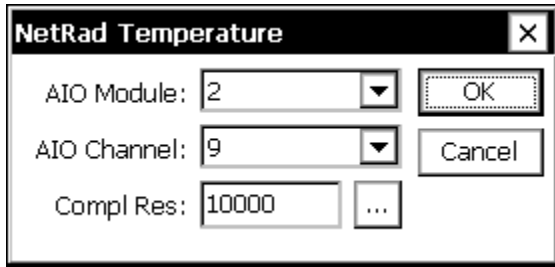

### ***Heater and Ventilator***

The CNR 4 optionally includes a Heater and Ventilator. The heater can be used to melt frost, and the ventilator is used to provide efficient air-flow over the domes and windows to minimize the formation of dew and reduce the frequency of cleaning.

The following dialog shows the properties used to configure CNR 4 heater operation. Ventilator configuration occurs in the NetRad Ventilator dialog, which looks and functions exactly the same.

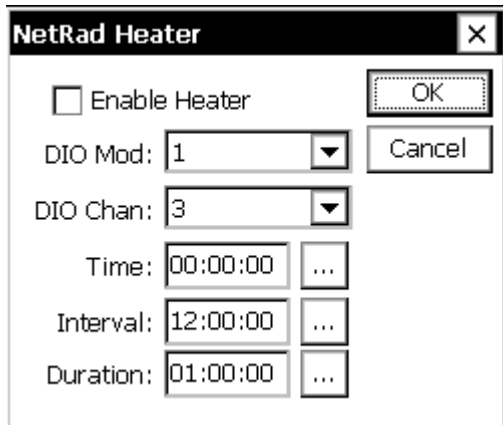

To enable heater operation, check the Enable Heater checkbox. When enabled, the system turns on the heater for the specified Duration, according to the specified schedule in Interval and Time. For example, if Time is “00:15:00”, Interval is “12:00:00”, and Duration is “01:00:00”, then every 12 hours at 12:15:00 and 00:15:00, the system will power the heater for 1 hour.





## Airmar PB200/200WX (PB200)

### Inputs

<none>

### Outputs

Dir – Wind Direction, degrees true

Speed – Wind Speed, m/s

BP – Barometric Pressure, bar

AT – Air Temperature, C

RH – Relative Humidity, %

DP – Dew Point, C

LAT – Latitude

LON – Longitude

### Description

The Airmar PB200/200WX sensor measures (or calculates) several meteorological parameters, including wind speed, wind direction, barometric pressure, air temperature, relative humidity, and dew point, as well as GPS position (LAT/LON) and UTC time. The 9210B “PB200” setup block enables you to read these parameters into the 9210B for further processing and/or logging. The following sections describe how to wire and configure the sensor for use with the 9210B.

### Wiring

Connect the PB200/200WX sensors to an RS232 or RS485 serial port. Connect the sensor as shown in the table, below.

| PB200 Pin # | PB200 Pin Name | Wire Color | RS485 Connection | RS232 Connection |
|-------------|----------------|------------|------------------|------------------|
| 1           | V+             | Red        | V+               | V+ (see PwrCtrl) |
| 2           | V-             | Black      | V-               | V-               |
| 3           | A/+ OUT        | White      | RS485A           | Tx               |
| 7           | A/+ IN         | Yellow     | RS485A           | Rx               |
| 8           | B/- IN         | Orange     | RS485B           | N/C              |
| 9           | B/- OUT        | Blue       | RS485B           | N/C              |

### Configuration

The PB200 properties dialog shown below is used to configure operation of the PB200 block.

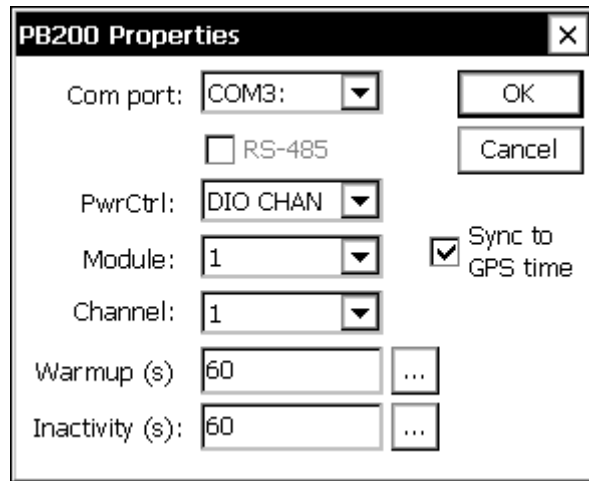

### **Com Port and RS-485**

Use the **Com Port** property to select the port on which you’ve connected the PB200/200WX sensor. If you’ve connected the sensor to an RS485 port, then check the **RS-485** option (note, COM4 may be either configured to either RS232 or RS485 on the 9210B by default, while ports COM6-COM9 are available as RS485 by factory option).

### **Power Control**

The **PwrCtrl**, **Module**, and **Channel** properties control when and how the sensor is powered. Power to the sensor can either be switched or constant. The following table describes connections and behavior for the different values of **PwrCtrl**:

| <b>PwrCtrl</b> | <b>Connections and Behavior</b>  |
|----------------|--|
| AIO SW12       | Connect sensor V+ to the SW12 terminal of the desired AIO module. For 9210B, this can be either the terminal marked “SW’D 12” on the top of the unit, or one of the SWBATT terminals on a connected AIO module, if any. When connecting to the terminal on the top of 9210B, set Module to 1. When connecting to an external AIO module, set Module to the number of the connected module. |
| DIO SW12       | Connect sensor V+ to the SW12 terminal of the desired DIO module. For 9210B, this can be either the terminal marked “SW’D 12” on the top of the unit, or one of the SWBATT terminals on a connected DIO module, if any. When connecting to the terminal on the top of 9210B, set Module to 1. When connecting to an external DIO module, set Module to the number of the connected module. |
| DIO CHAN       | This option is used when connecting sensor power to an external relay controlled by a 9210B digital output channel. Connect sensor V+ to the power supply terminal of the relay. Connect the relay control signal to the DIO module output channel. Set Module to the number of the DIO module   |

|         |  |
|---------|--|
|         | (1 if using a digital channel via 9210B top panel connector). Set Channel to the number of the output channel controlling the relay. |
| PROT 12 | Connect sensor V+ to the PROT 12 terminal of the 9210B (or other connector that provides constant 12V)                               |

### **Warmup (s)**

The PB200/200WX takes several seconds following power-on before valid data is produced. The Warmup property is used to define how long to wait before attempting to read data from the sensor after it is first powered on. Increase this value until the 9210B no longer consistently logs this sensor's data with BAD quality following sensor power-on. Note: this property is ignored when PwrCtrl is set to "PROT 12".

*Special note for averaging: the Average and VecAvg blocks require at least 50% of the incoming samples to be of good quality, in order for the averaged values to be set to good quality. Hence, either the average block's sampling duration must be over twice the warmup time, or the inactivity timeout (below) must be set to ensure the PB200 is powered on for subsequent measurement intervals.*

### **Inactivity (s)**

This property defines how many seconds of inactivity (no measurements) may occur after a measurement before the sensor is powered down. Since the PB200/200WX sensor takes several seconds following power-on to produce valid data, it often makes sense to not turn off power to the sensor during times of frequent measurements (e.g., when averaging for only a portion of a measurement interval).

To ensure the sensor is not powered off before the next sample, set Interval to a value greater than the measurement interval. If instead you wish the sensor to power off after each sample (and therefore force the sensor to wait the Warmup time on every measurement), then set Interval to some small value (e.g., 0).

### **Sync to GPS Time**

This property determines whether the PB200 block should set the 9210B system time to the UTC time obtained from the PB200/200WX sensor.



## Platinum RTD (PlatRTD)

### Inputs

<none>

### Outputs

PlatRTD

### Wiring

Connect the sensor as shown below. If the sensor only has 3 wires, then Jumper excitation channel (-) to channel (+) and use a single wire from channel (+) to the sensor.

\*You may use a 1K-completion resistor for greater accuracy. If using a 1K-completion resistor, set the 0C Ohms to 10x the calibrated value for the sensor.

NOTE: DO NOT USE CHANNELS ABOVE 8 FOR EXCITATION

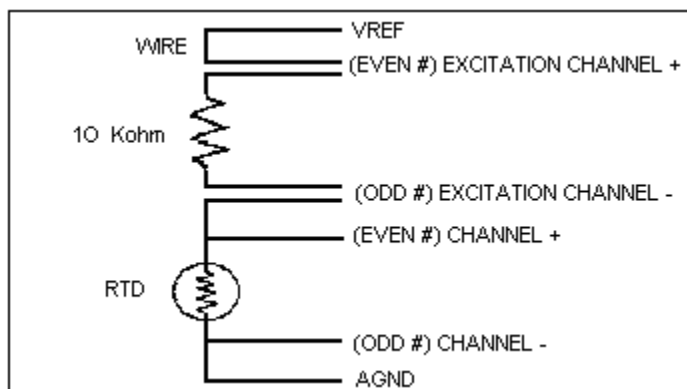

### 4-Wire Mode

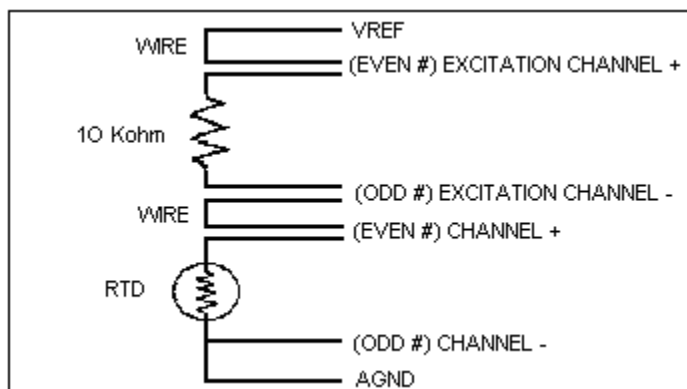

### 3-Wire Mode

### Description

The Platinum RTD block is used for measuring a 100 ohm platinum temperature devices. The dialog allows the selection of the block channel and excitation. The type is also selectable

between 385 and 392 type devices. The resistance at zero degrees can be set for calibration purposes. The system will do a differential measurement so always select an odd channel number (1, 3, 5...).

High resolution readings will take longer than non-high resolution readings. The high resolution check box should not be checked unless the sense resistor is at least 39 times the 0 degree resistance. This means for a 100 ohm PRTD, the smallest sense resistor that can be used with the high resolution box checked is 4K.

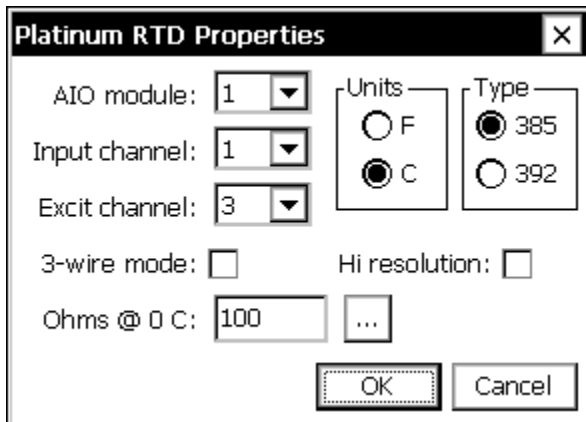

Note: If the Platinum RTD conforms to DIN 43760, IEC 751, or IEC 60751, then select type 385.



## Quadrature Shaft Encoder

### Inputs

<none>

### Outputs

Level

### Wiring

Wire the pair of Quadrature outputs to digital channels 3 and 4, 5 and 6, or 7 and 8. Note: channels 1-2 cannot be used for quadrature. To use channels 7-8, apply external pull-up resistors if the output of the sensor is not driven. If counts are in the wrong direction, either reverse wires or change the rotation setting in the properties.

Power the sensor off +12V and GND.

### Description

This block is used to collect data from an incremental/Quadrature shaft encoder through a Digital I/O Module. Up to three Quadrature shaft encoders may be set up on one module. The signal lines from each encoder must hook-up to adjacent I/O module inputs starting with an odd-numbered one (e.g. 3-4, 5-6, or 7-8).

Select the module and channel pair number the encoder is hooked-up to (odd channel - 3, 5 or 7). Enter the wheel diameter, the rotation direction that results in a positive increase to the output, and the units for the block to output in. The Counts per Turn drop down box allows you to select 100, 256, 400, and 800 counts per turn in order to support different shaft encoders.

The Quadrature shaft encoder block contains a calibrate procedure. The calibrate procedure is used to set the reading to a user set value. This is important to do whenever the 9210 is restarted or maintenance is done on the sensor. The calibration procedure is run from the Sensors tab or the Calibrate menu on the front panel.

**Quadrature Shaft Encoder Properties**

DIO Module: 1

Channel: 3

Wheel Circumference: 1 Foot

Other Circumference: 1

Counts per Turn: 100

Rotation:  CW  CCW

Units:  ft  m



## R.M. Young Wind Sensor (RMyoung)

### Inputs

<none>

### Outputs

Speed

Dir

### Wiring

Wind Direction

|       |   |
|-------|---|
| AZEXC | Connect to selected excitation channel on the analog module.<br>Jumper excitation channel to VREF. NOTE: DO NOT USE CHANNELS ABOVE 8 FOR EXCITATION |
| AZSIG | Connect to selected input channel on the analog module.   |
| REF   | Connect to GND  |

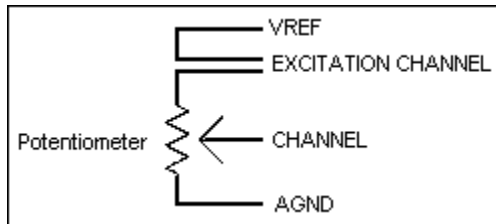

### Powered Sensors

WS Sig connect to selected input channel (CH1..CH6) of digital module. Note CH7 and CH8 reserved for non-powered sensors with low level outputs.

V+ Supply connect to PROT12

REF connect to GND

### Non-Powered Sensors

WS Sig connect to digital CH7 or CH8 of digital module

Note: The direction potentiometer of most models of the RM Young wind sensor has a 5 degree electrical open from 355 to 360 degrees. A one megohm resistor can be placed from the AZSIG (input channel) to AZEXC (excitation channel) or AGND to define the direction as 355 degrees (AZEXC) or 0 degrees (AGND) in the open region.

### Description

This block is designed to make measurements from an R.M. Young wind sensor, models 5103 or 5305. One analog input and one excitation channel (analog output) is needed on an Analog I/O

module to determine wind direction. Wind direction requires connection to Digital Module input channel. The units for wind speed can be set to mph, mps, kph, fps, or knots.

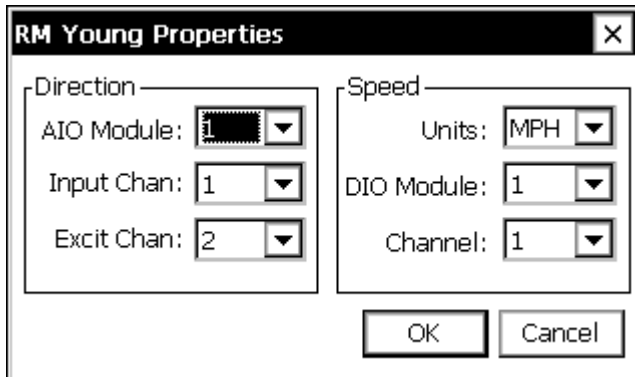



## **SDI 12** SDI-12

### **Inputs**

<None>

### **Outputs**

Output 1

...

Output 20

### **Wiring**

All SDI-12 sensors wire to GND, +12 and Data on the 9210. Multiple wires can be connected to the same connections.

### **Description**

This general-purpose sensor block is used to obtain data from a SDI-12 sensor (parameters 1 through 20; to retrieve a parameter above 20, please use the Xpert Basic “SDICollect” function).

Select the SDI-12 address of the sensor, the measurement command type\* and the units to report with the reading. The C (concurrent measurement) command is only supported by SDI sensors versions 1.3 and higher.

\*NOTE: The only supported commands are V, M, MC, M1 - M9, C, CC, C1 - C9, R0-R9, RC0-RC9. To get other types of measurements, a basic program using the SDI function must be used (SdiCollect does not work, so data must be parsed by the program).

The block scales the outputs according to the values of *Slope* and *Offset* using the equation  $output = reading * slope + offset$ .

The user can change the units for all the outputs by changing the *Units* field to the desired value.

The block supports calibration from the Sensors page and the Xlite front panel display. For the calibration, the user will enter the current value sensor. The system will then adjust the offset so the desired value is obtained.

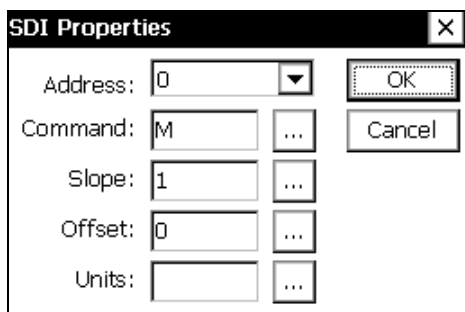

SDI Properties

Address: 0

Command: M

Slope: 1

Offset: 0

Units:

OK

Cancel



## SDI AquaTrak (SDIAqua)

### Inputs

<none>

### Outputs

Average

Std

Outliers

Cals

Quality

### Wiring

SDI-12 port

### Description

The SDI AquaTrak block is designed to operate with the Aquatrak 4100 series controller and sensor heads for measuring water level. The Aquatrak sensor must be configured separately to specify the measurement modes and desired averaging algorithm and number of samples to take. The typical configuration uses the NOS DQAP algorithm measuring 181 samples.

Once configured, the 9210 will make measurements using the standard SDI M command or C command, if Concurrent is selected.

Testing has shown that the Aquatrak controller tends to ignore the retries that come very quickly as part of the normal SDI-12 retry process. Hence, this block performs an additional retry after the user-specified Retry Delay. This delay should be set to 2000 minimally when Concurrent is selected, and set to 3000 minimally when Concurrent is not selected.

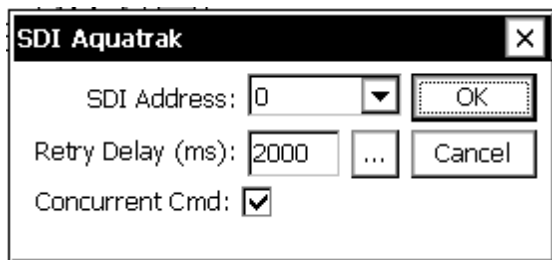



## SE8500 (SE8500)

### Inputs

<none>

### Outputs

Output

### Wiring

The SE8500 can connect to any of the 9210 serial ports. The SE8500 wires to the 6461-1239 termination board as follows:

| Color | Name | Pin<br>(6461-1239) |
|-------|------|--------------------|
| Red   | +12  | 6                  |
| BLK   | GND  | 5                  |
| White | TXD  | 3                  |
| Green | RXD  | 2                  |

### Descri

### ption

This block measures a SE8500 configured for serial output. It can also work with an SE8500 connected to a wireless link. The properties allow setting the Com Port, range, offset, address and units. **NOTE:** Leave the settings in the SETUP TAB/ COMS (SSP/CL) set to none, as this block will not be able to use the com port if Coms (SSP/CL) is already using it. Address specifies which address the SE8500 is set to. Typically address is 0. Other valid addresses are 1..9, A..F.

After the value is read from the SE8500 it is scaled as follows:

$$\text{Value} = \text{reading} * \text{range} + \text{offset}.$$

Range is typically 0.01 because the SE8500 multiples its value by 100 before sending it. However, you can select a different range value if desired.

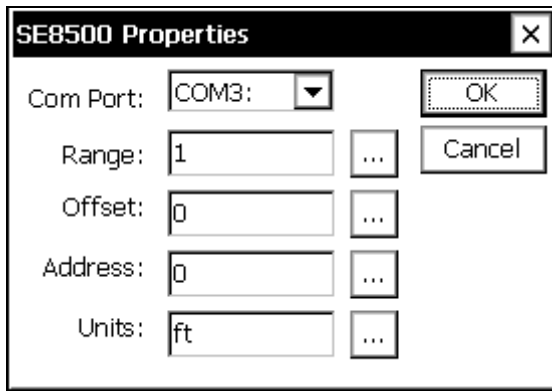



## Send Current Time (SendTime)

### Inputs

<none>

### Outputs

<none>

### Description

This block is used to synchronize the system time of connected units that “speak” SSP (e.g., other 9210s, Xperts, 8210s, etc.). This block sends an SSP “set-time” message containing the current system time to the destination unit(s) specified by the “Path” property. The message is sent periodically according to the scheduling parameters “Time” and “Interval”.

To broadcast the set time message to all listeners, set the “Path” property to “\*”. Otherwise, enter a specific station name or station path (e.g., *\patha\pathb\stationx*).

Set the “Port” property to the communications port to which the other device(s) is(are) connected. This com port must already be defined in the Setup Tab under COMS (SSP/CL).

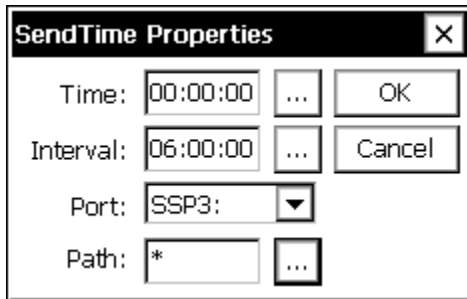

## **Soil Mstr** Soil Moisture (SoilM)

### **Inputs**

<none>

### **Outputs**

Dielectric

Moisture

Temp

### **Wiring**

Connect the sensor output (green) to the selected channel on the analog module.

If the Type is moisture + temperature, connect the temperature output (blue) to the next higher channel.

Connect the sensor ground (white) to GND

Connect the sensor power (red) to SW'D 12V.

### **Description**

This block supports Sutron's 5600-0089 soil moisture/temperature sensor. The type box supports the following:

|                        |  |
|------------------------|--|
| Moisture               | Measure moisture only  |
| Moisture + temperature | Measure moisture and temperature on a separate channel                         |
| Moisture + temp muxed  | Measure moisture, wait 5 seconds, then measure temperature on the same channel |

The "use digital" check box allows you to specify a digital channel to enable individual sensors (see page 8 of the sensor manual for more details). Do not use digital channel 1!

The cable correct check box directs the software to apply the cable-offset correction as explained on page 12-13 of the sensor manual.

**Soil Moisture Properties** [X]

Type: moisture [v] [OK]

Analog Mod: 1 [v] [Cancel]

Analog Chan: 1 [v]

Use Digital:

Digital Mod: 1 [v]

Digital Chan: 2 [v]

Cable Correct:



## Soil Temperature (SoilTemp)

### Inputs

<none>

### Outputs

Soil Temperature

### Wiring

The sensor is measured single ended. Hence, connect the sensor's V+ to any analog input channel CH1.. CH10, and signal ground to AGND. Connect power as desired.

### Description

The SoilTemp block is used to measure soil temperature sensors. The following dialog is used to configure the block for measurement:

The screenshot shows a dialog box titled "SoilTemp" with a close button (X) in the top right corner. It contains three dropdown menus and a radio button group. The "Model:" dropdown is set to "LI-COR 7900-180". The "AIO Module:" dropdown is set to "1". The "AIO Channel:" dropdown is set to "7 \*". Below these is a "Units" section with two radio buttons: "F" (unselected) and "C" (selected). To the right of the dropdowns are "OK" and "Cancel" buttons.

Select the type of soil temperature sensor in Model, and specify the analog I/O module and channel in AIO Module and AIO Channel. Select the Units for the output.



## Solar Radiation (SolRad)

### Inputs

<none>

### Outputs

SolRad

### Wiring

Connect the sensor output to the selected channel on the analog module CH1..CH10

Connect the sensor ground to GND.

### Description

This block supports all the solar radiation sensor sold by Sutron, part numbers 5600-0600, -0601, -0602, -0603, and -0605. All of these utilize one channel (analog input) on an Analog I/O module. Select the sensor part number and the units for the block to output in. The *Calibration* is used in the equation:

Solar Radiation = mv/calibration.

The units for *Calibration* are typically millivolts per watt per meter squared. The sensor manufacturer typically supplies the value for calibration. If the units supplied by the manufacturer are in a different format, convert them prior to entering the calibration value.

Specify in “Warmup (ms)” the number of milliseconds the I/O module should wait before taking the measurement. This wait time allows the module to settle in order to make an accurate measurement.

The screenshot shows a dialog box titled "Solar Radiation" with a close button (X) in the top right corner. The dialog contains the following fields and controls:

- Analog I/O Module: A dropdown menu showing "1" and an "OK" button.
- Channel: A dropdown menu showing "3" and a "Cancel" button.
- Units: A text box containing "W/m2" and an ellipsis button "...".
- Calibration: A text box containing "1" and an ellipsis button "...".
- Warmup (ms): A text box containing "100" and an ellipsis button "...".
- Gain Selection: Three radio buttons labeled "Normal Gain" (selected), "Hi Gain", and "x128 Gain".

With the exception of the 5600-0604, the Hi Gain setting is typically used for solar radiation sensors. It is possible to use the x128 setting if the expected range of irradiance is low enough to ensure that the output voltage will be less than 19 mV, but due to the high resolution of the analog to digital converters used, there is rarely a need for the x128 range.



When using Hi Gain, the input voltage should be less than 78mV when using the internal Analog I/O Module or the 8080-0007 Analog I/O Module, and less than 312mV when using the 8080-0003 Analog I/O Module. When using x128 Gain, the input voltage should be less than 19mV when using either the internal Analog I/O Module or the 8080-0007 Analog I/O Module, and less than 39mV when using the 8080-0003 Analog I/O Module.

See the table below for the voltage ranges of Sutron Solar Radiation sensors. A check “√” in a gain column means the selected gain is appropriate for that sensor. An “x” in a gain column, means the selected gain is not appropriate for that sensor.

| Part Number | Max Output   | Normal Gain | Hi Gain | x128 Gain |
|-------------|--|-------------|---------|-----------|
| 5600-0600   | Typ. 40 mV @ 3000 W m <sup>-2</sup>                      | x           | √       | √         |
| 5600-0601   | 30 mV @ 2000 W m <sup>-2</sup>                           | x           | √       | √         |
| 5600-0602   | Typ. 25 mV @ 2800 W m <sup>-2</sup>                      | x           | √       | √         |
| 5600-0603   | Typ. 30 mV @ 10,000 μmol s <sup>-1</sup> m <sup>-2</sup> | x           | √       | √         |
| 5600-0604   | Typ. 200 mV @ 2000 W m <sup>-2</sup>                     | √           | √*      | x         |
| 5600-0605   | 70mV @ 2000 W m <sup>-2</sup>                            | x           | √       | √         |

\* - Acceptable only when measured using 8080-0003 Analog I/O module.



## Submersible Pressure Transducer (SubPres)

### Inputs

<none>

### Outputs

PressEng

### Wiring

Wire to SDI-12 port

### Description

This block supports the Sutron 56-109 Submersible Pressure Transducer. This SDI-12 sensor is used to measure water level or pressure in well or surface water applications. The averaging time can be used to increase the measurement accuracy by lengthening the sampling time, and/or for situations where there are waves on the water surface. Unit options are ft, PSI, kPa, m, cm, or mm.

The screenshot shows a dialog box titled "Submersible Pressure Properties" with a close button (X) in the top right corner. The dialog contains the following fields and controls:

- SDI Address:** A dropdown menu showing "0" and an "OK" button to its right.
- Averaging time:** A text input field containing "10", followed by an ellipsis button "...", and a "Cancel" button to the right.
- Offset:** A text input field containing "0", followed by an ellipsis button "...".
- Units:** A dropdown menu showing "water ft".

## **T<sub>B</sub>** Tipping Bucket Sensor (Precip)

### Inputs

<none>

### Outputs

Precip

### Wiring

Connect one side of the tipping bucket switch to the selected digital channel. Note: do not use channel 1. If using channels 7 or 8, you must apply an external pull-up resistor to +5V (prot +12 will also work).

Connect the other wire to GND.

### Description

This block works with reed, wetted reed, and magnetic tipping buckets. The tipping bucket output hooks to one input of a Digital I/O module. Set *Tip* to the amount of rainfall associated with one bucket tip. The supported Tips are 0.1mm, 0.2mm, 0.25mm, 0.3mm, 0.5mm, 1.0mm, 0.01", and 0.008". *Filter* can be increased to eliminate extra readings due to bucket bounce; however, the default value should suffice for most units. The output of this block is the total amount of rain that has fallen since sampling began.

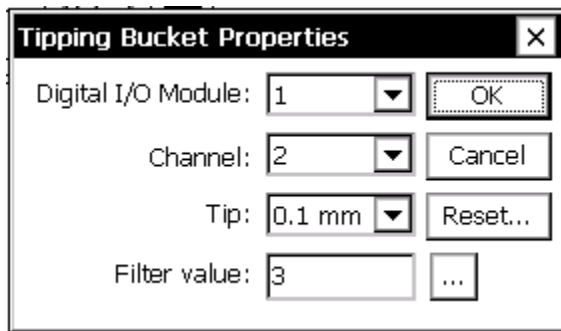

### Reset

The tipping bucket block can reset to 0.0 according to a schedule you specify, if desired. Press the “Reset” button to bring up the following dialog to configure the reset:

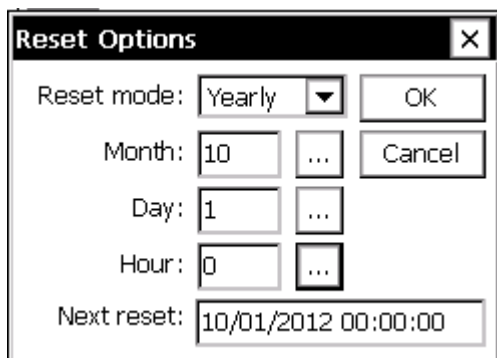

Set “Reset mode” to either None, Yearly, Monthly, or Daily. Set Month, Day, and Hour to indicate the desired time to reset. Month ranges from 1 to 12, Day from 1 to 31, and Hour from 0 to 23. In the example shown above, the reset will occur every year, at midnight October 1<sup>st</sup>. Note how the next reset is computed shown. This can help you figure out if your settings will produce the desired result.

### ***Calibrate***

The tipping bucket block contains a calibrate procedure. The calibrate procedure is used to set the reading to a user set value, or to run a calibration test. This is important to do whenever the 9210 is restarted. The calibration procedure is run from the Sensors tab, Calibrate button, or the Calibrate menu on the Xlite front panel display.

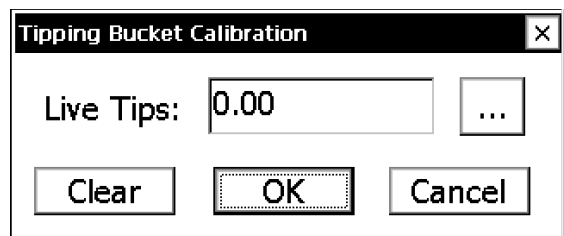

When the calibration is entered, the old value of the tipping bucket is preserved and is “locked”. This means that if recording is still on and the system measures or logs the tipping bucket, the old value is used. The “Live Tips” display always starts out initially at zero and updates very rapidly. It will increment as the tipping bucket tips. You may enter a new value by pressing the [...] button. To restore the old value and return to normal operations at any time just press the cancel button. To accept the displayed value and make it become the new value, press the OK button.

To test the tipping bucket, enter the calibration screen, add a specific amount of water to the tipping bucket, and observe the read-out. Press cancel when done.

To correct the tipping bucket, enter the calibration screen, press the [...] button, and enter the correct value. Press ok when done.

When performing calibration using the 2x20 Display the calibration and test screen appears like this:

```
TIPS = 0.00
< CLR * SET > DONE
```

To test the tipping bucket, pour water in to the tipping and observe the read-out. The read-out will be updated rapidly. When you are done, press the > (DONE) key, and then select CANCEL from the confirmation screen to throw away the test value.

To correct the tipping bucket, press \* (SET), and enter the new desired level in to the following screen:

```
TIPS=+00000005.25  
<OK>          <CANCEL>
```

Select OK to accept the change and return to the live display. Press the > (DONE) key, and then select OK from the confirmation screen to accept the new value.



## Volt Meter (VoltMeter)

### Inputs

<none>

### Outputs

AIOVolt

### Wiring

Connect the voltage output to the analog channel selected CH1..CH10.

Connect a ground from the sensor to GND

### Description

Voltmeter is a general-purpose block for measuring a voltage from an Analog I/O module analog input. User selections are available for the I/O module and channel (analog input), warm-up time, slope, offset and reported units.

The formula for calculating the reading is:  $Output = V_{in} * Slope + Offset$

Default units is "volts", this may be changed to match desired reading (E.G. "Degrees C").

The *Settling Time (Warm Up)* can be adjusted to adapt either to long sensor signal settling times, or to give the voltage reference in the Analog I/O Module a longer time to warm-up for increased converting accuracy.

The block scales the outputs according to the values of *Slope* and *Offset* using the equation  $output = reading * slope + offset$ .

The user can change the units for all the outputs by changing the *Units* field to the desired value.

The block supports calibration from the Sensors page and the Xlite front panel display. For the calibration, the user will enter the current value sensor. The system will then adjust the offset so the desired value is obtained.

**Voltmeter (DC) Properties**

Analog I/O Module: 1 [OK]

Channel: 1 [Cancel]

Settling Time (ms): 100 [...]

Slope: 1 [...]

Offset: 0 [...]

Units: V [...]

HiGain:



## Vibrating Wire (VWire)

### Inputs

None

### Outputs

None

### Wiring

One or more Campbell Scientific AVW200 Vibrating Wire Interface devices connected to RS232 com ports. See AVW200 documentation for wiring of vibrating wire sensors to it.

### Description

The Vibrating Wire block measures vibrating wires connected to one or more Campbell Scientific AVW200 Vibrating Wire Interface devices. The AVW200 devices are connected to the logger via RS232 COM port.

The block does not have any properties to configure in the graphical setup. Instead, a comma-separated-value (CSV) text file is used to define the configuration. Here's an example CSV file:

```
Name,Enabled (Y/N),Time (HH:MM:SS),Interval (HH:MM:SS),COM Port,Channel (1/2),A,B,C,K,T0,S0,S1 Name
PZ72A,Y,0:00:00:000,0:00:05,COM3:,1,-7.395E-08,-0.02281,212.0283952,0.01279,21.01535,992.3,
PZ72B,Y,0:00:01:700,0:00:05,COM3:,2,-9.019E-08,-0.02363,216.9210467,0.005873,21.13562,992.3,
PZ72C,Y,0:00:00:450,0:00:05,COM4:,1,-7.395E-08,-0.02281,212.0283952,0.01279,21.01535,992.3,
PZ72D,Y,0:00:02:150,0:00:05,COM4:,2,-9.019E-08,-0.02363,216.9210467,0.005873,21.13562,992.3,
PZ74A,Y,0:00:00:900,0:00:05,COM7:,1,-7.395E-08,-0.02281,212.0283952,0.01279,21.01535,992.3,
PZ74B,Y,0:00:02:600,0:00:05,COM7:,2,-9.019E-08,-0.02363,216.9210467,0.005873,21.13562,992.3,
PZ74C,Y,0:00:01:350,0:00:05,COM8:,1,-7.395E-08,-0.02281,212.0283952,0.01279,21.01535,992.3,
PZ76A,Y,0:00:03:050,0:00:05,COM8:,2,-9.019E-08,-0.02363,216.9210467,0.005873,21.13562,992.3,
PZ76B,Y,0:00:01:800,0:00:05,COM9:,1,-7.395E-08,-0.02281,212.0283952,0.01279,21.01535,992.3,
PZ76C,Y,0:00:03:500,0:00:05,COM9:,2,-9.019E-08,-0.02363,216.9210467,0.005873,21.13562,992.3,
```

The fields of the file are defined as follows:

- "Name": the desired tag name for the computed water level. The tag name may refer to the name of a ComsTag block in the graphical setup, which can then be measured to log and/or transmit measured values
- Enabled: "Y" or "N". Setting to "N" disables the measurement
- Time and Interval determine the measurement time and interval, and should be formatted "HH:MM:SS"
- COM Port: name should include the colon, e.g., "COM2:", "COM3:", etc.
- Channel (1/2): The AVW200 channel to measure (either 1 or 2)
- A, B, K, T0, and S0 readings come from Geokon 4500S cal sheet
- C is typically a calculated value. It can be computed initially based on calibration sheet information. It can be recalculated in field during installation, if desired, to improve accuracy
- S1 Name: Reference Barometric correction. This is optional. If unused, leave blank

# PROCESSING BLOCKS

---



## Alarm

### Inputs

Input

### Outputs

Hi Alarm – True (1) if the data is in Hi Alarm, otherwise false (0)

Lo Alarm – True (1) if the data is in Lo Alarm, otherwise false (0)

Data – pass through of the data

ROC Alarm – True (1) if the data is in ROC Alarm, otherwise false (0)

Any Alarm – True (1) if the data is in any alarm, otherwise false (0)

### Description

The Alarm block checks the input data for alarms. The Alarm Properties allow the Alarm block to be configured to detect Hi Alarms, Lo Alarms and ROC Alarms. The same deadband applies to all types of alarms.

The Alarm block is also used to configure the unit to send out ALERTS (transmissions due to alarm). See the following chart for details:

|                            |           |  |
|----------------------------|-----------|--|
| HI Mode<br>and<br>LOW Mode | OFF       | Do not send out an alert, only go into alarm.  |
|                            | ABOVE     | Send an alert when the value goes above the HI limit + deadband  |
|                            | BELOW     | Send an alert when the value goes below the HI limit - deadband  |
|                            | BOTH      | Send an alert when the value goes above the HI limit + deadband OR when the value goes below the HI limit - deadband |
| Alert on<br>ROC Alarm      | Checked   | Send an alert based on the ROC mode. Above or Below.   |
|                            | Unchecked | Do not send out an alert.  |

Alerts will only occur when the conditions set above are met, and will continue until acknowledged (note: alerts over Iridium and/or GPRS are effectively acknowledged once the transmission completes).

Once in alarm, the unit will stay in alarm until the conditions are no longer met. Certain devices under the COMS (SSP/CL) menu can have alert disabled, see the section under COMS (SSP/CL) for more information. If the unit is configured under the COMS (SSP/CL) menu to send data at an ALARM interval (anything other than 00:00:00) the unit will continue sending out that data.



Note: Iridium and GPRS devices are not managed under the COMS (SSP/CL) menu, and are not subject to the ALARM interval.

The screenshot shows a dialog box titled "Alarm Properties" with a close button (X) in the top right corner. The dialog contains the following controls:

- Enable Hi Alarm:
- Enable Low Alarm:
- Hi Limit:
- Low Limit:
- Hi Mode:
- Low Mode:
- ROC Mode:
- ROC Fixed Interval:
- ROC Lvl:
- Alert on ROC Alarm:
- Deadband:

At the bottom of the dialog are two buttons: "OK" and "Cancel".

|                      |  |
|----------------------|--|
| Hi Alarm             | Go into alarm if the input value is $> \text{Hi Limit} + \text{deadband}$  |
|                      | Go out of alarm if the input value is $< \text{Hi Limit} - \text{deadband}$  |
| Low Alarm            | Go into alarm if the input value is $< \text{Low Limit} - \text{deadband}$   |
|                      | Go out of alarm if the input value is $> \text{Low Limit} + \text{deadband}$   |
| Rate Of Change Alarm | <ol style="list-style-type: none"> <li>When ROC Mode is set to Off, no ROC alarm test occurs.</li> <li>When ROC Mode is set to Hi, the system goes into alarm if the change in input value is <math>&gt; \text{ROC Mag} + \text{deadband}</math>. The system goes out of alarm when the change in input value is <math>&lt; \text{ROC Mag} - \text{deadband}</math>.</li> <li>When ROC Mode is set to Low, the system goes into alarm if the change in input value is <math>&lt; \text{ROC Mag} - \text{deadband}</math>. The system goes out of alarm when the change in input value is <math>&gt; \text{ROC Mag} + \text{deadband}</math>.</li> <li>The change in input value is computed in one of two ways, depending on the state of Fixed Interval. If Fixed Interval is checked, the change in input is calculated as the absolute value of the difference between the current value and the last value.<br/><br/>If Fixed Interval is not checked, the change in input is calculated as the absolute value of the difference between the current value and the last value that caused a ROC Alarm to occur. Since no alarm has occurred on the start of recording, the first reading taken after the press of START recording (Or power up) is used as the basis to determine ROC alarm, once the unit goes into alarm, the alarm value becomes the basis for the next alarm.</li> </ol> |



## Accumulator (Accum)

### Inputs

Data – the data to accumulate

Enable – enable/disable the accumulation; when input is disconnected or input value is non-zero, accumulation is enabled

### Outputs

TAccum – Trigger accumulation. Output when the running accumulation surpasses the threshold value.

Accum – Accumulation since last scheduled reset.

Trigger – Trigger. Output set to 1 when the running accumulation surpasses the threshold value.

PTotal – Previous total that is value of accumulation at scheduled reset.

### Description

The Accum block is used to accumulate input data and to set outputs based on the current accumulation. This block is typically used as a part of a system to monitor and control a water sampler where blocks before the accumulator measure level and flow, compute discharge, and compute discharge\*time. This block then accumulates the total flow and sets a trigger every time a selected amount of flow has been registered. The total flow is reset to 0 at a user set schedule, typically daily. The trigger typically connects to a pulse output block.

The screenshot shows a dialog box titled "Accum Properties" with a close button (X) in the top right corner. It contains three rows of input fields, each followed by an ellipsis button (...):  
1. "Time:" with a text box containing "00:00:00".  
2. "Interval:" with a text box containing "24:00:00".  
3. "Threshold:" with a text box containing "0".  
Below these fields is a checkbox labeled "Include negative values:" which is currently unchecked. To the right of the input fields are two buttons: "OK" and "Cancel".

Use the *Time* and *Interval* properties to set the schedule at which the block resets the accumulation.

Use the *Threshold* property to specify the value of accumulation that, when reached, is a signal to set the trigger output to 1.

Check “Include negative values” to allow negative input values to be included in the accumulation. When not checked, negative input values are not included.



## Average (Average)

### Inputs

Input

### Outputs

Average – Computes the mean average of the samples taken during the *Duration*.

Min – Outputs the minimum of the samples taken during the *Duration*.

Max – Outputs the maximum of the samples taken during the *Duration*.

STD – Computes the standard deviation of the samples taken during the *Duration*.

Count – Outputs the number of samples that were used to compute the average.

### Description

The Average block is like a Measure block that can perform some common data processing functions related to averaging. The block can output the average (mean), maximum, minimum, standard deviation, or sample count (number of samples) from a series of data points sampled from a sensor.

The *Schedule Interval* indicates how often the Average block should sample a series of data points, process them, and output a value. The *Schedule Time* specifies the synchronization of when this should begin. The *Sample Interval* entry indicates how often the sensor should be sampled each time its scheduled to sample and the *Sample Duration* specifies for how long. To average continuously, the *Schedule Interval* should be set equal to the *Sample Duration*.

Note: *Sample Interval* may be set to milliseconds for sub-second sampling. For example, the value 00:00:00:500 would cause sampling to occur every 500 milliseconds. When specifying milliseconds, you must specify all three digits.

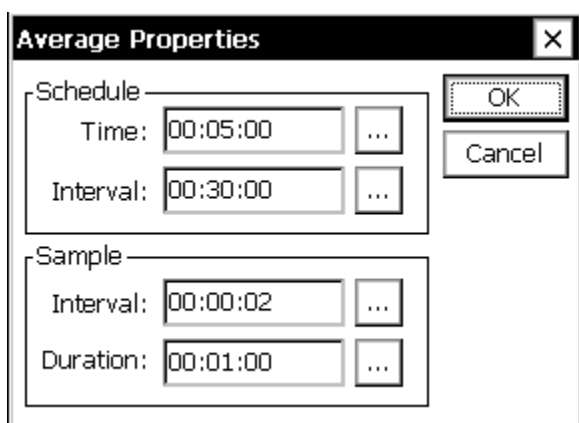

The example above shows an Average block that will perform its averaging every 30 minutes, starting at an offset of 5 minutes from the hour. When averaging starts, samples will be taken every 2 seconds, for a duration of 1 minute. At the time of the last sample, all the block's outputs (mean, min, max, etc.) are computed and are output. Note: **the timestamp assigned to all the**

**output data is the time of the last sample.** In the example above, the timestamp for the averaging period started at 12:35:00 would be 12:35:58. **Note: To shift the timestamp so that it occurs at the end of the Sample Duration, increase the Schedule Time by one Sample Interval.** In the example above, this means set Time to 00:05:02, so that the timestamp occurs at the top of each minute, e.g., 12:36:00.

The output quality of the averaged result will be good, as long as at least half of the anticipated samples can be taken successfully. The initial average calculation after recording start may contain fewer samples than subsequent runs, since the calculation begins on the first sample interval that comes along after recording is started.



## Bool (Boolean)

### Inputs

X

Y

### Outputs

Output

### Description

The Boolean block is used to perform boolean operations on the two inputs, X and Y, and output the result in Output. Non-zero data values are considered “true”. A “true” output is assigned the value of 1.

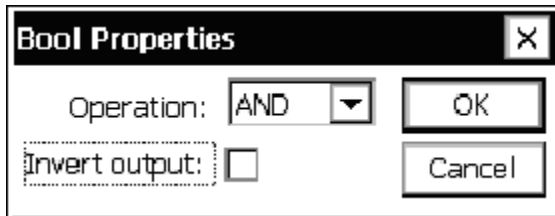

The *Operation* property can be set to one of “AND”, “OR”, or “XOR”. The table below defines the output given all the possible different inputs and operations.

| Inputs |       | Output |       |       |
|--------|-------|--------|-------|-------|
| X      | Y     | AND    | OR    | XOR   |
| true   | true  | true   | true  | false |
| true   | false | false  | true  | true  |
| false  | true  | false  | true  | true  |
| false  | false | false  | false | false |

When the *Invert Output* check box is selected, the outputs shown in the table are inverted.

### Block Placement

The Boolean block should typically come BEFORE the measure (or average, or other “active” block) that executes it. This ensures the block operates on data from the same measurement frame, and avoids odd side effects that come from active blocks operating on split paths.



## CS625 Water Content Reflectometer (CS625WCR)

### Inputs

Frequency (Freq)

Soil Temperature C (SoilTemp)

### Outputs

Volumetric Water Content (VWC)

### Description

This block is used to compute Volumetric Water Content (VWC) using a CS625 Water Content Reflectometer sensor.

### Wiring

The CS625 sensor's output should be wired to the input of the 6461-1285 frequency divider. The output of the divider should be connected to the input of the DIO module. A Frequency block is used to measure the input frequency. Set the sample period of the Freq block to 200mS.

The VWC calculation can be compensated for the current soil temperature, if desired. To do so, connect a block measuring the current soil temperature to the Soil Temperature input of the CS625WCR block. You may choose to use a Const block (providing a constant value), if soil temperature does not change enough to require additional compensation.

The diagram below shows a typical graphical setup of the CS625WCR block, compensated for soil temperature using a constant value entered into the Const block. To compensate for soil temperature using a measured value, replace the Const block with a sensor block configured to measure the current soil temperature. To assume a constant soil temperature of 20 C, do not connect any block to the Soil Temperature input.

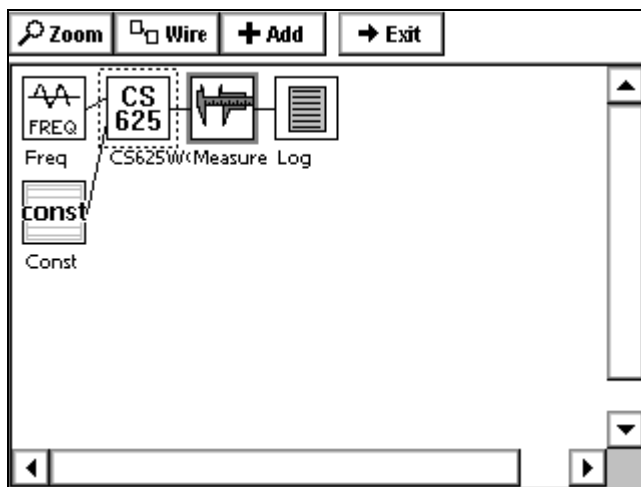

### Properties

The CS625WCR block properties dialog is shown below:

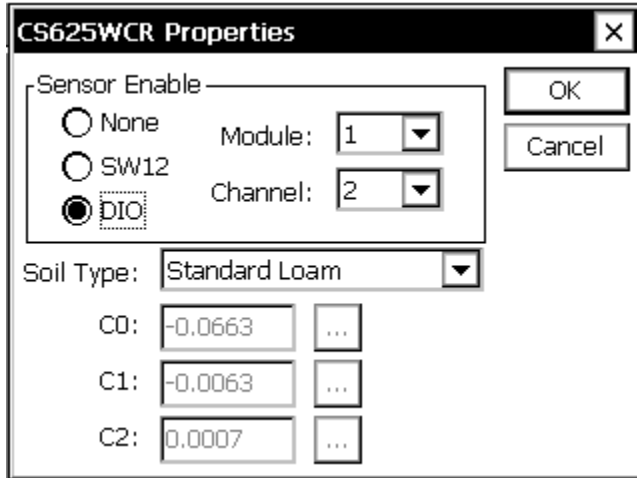

“Sensor Enable” controls how the sensor is enabled for measurement. If “None” is selected, the sensor is not enabled automatically (the sensor should be wired so it is always enabled, though this does result in more power consumption). When “SW12” is selected, the sensor enable should be wired to the SW BATT/12 output of the DIO module. When “DIO” is selected, the sensor enable should be wired to the DIO module and channel indicated in the “Module” and “Channel” properties.

Set “Soil Type” to the appropriate selection based on actual soil type. The coefficients C0, C1, and C2 change based on the soil type selected. Select a soil type of “User Defined” to enter your own coefficients.

### Block Placement

The CS625WCR block should typically come BEFORE the measure (or average, or other “active” block) that executes it. This ensures the block operates on data from the same measurement frame, and avoids odd side effects that come from active blocks operating on split paths that recombine.



## Dew Point (DewPt)

### Inputs

temperature

humidity

### Outputs

dew point

### Description

This block computes dew point from temperature and humidity. The temperature input may have units of either Celsius or Fahrenheit (the units field of the incoming data is used to determine which is in effect). The humidity input is expected to be a percentage.

The dew point output is expressed in the same units as the incoming temperature.

The block has no user-set properties. Dew point is computed according to the “WMO Guide to Meteorological Instruments and Methods Observation” WMO-No.8 seventh edition, 2006.

### Block Placement

The Dew Point block should typically come BEFORE the measure (or average, or other “active” block) that executes it. This ensures the block operates on data from the same measurement frame, and avoids odd side effects that come from active blocks operating on split paths that recombine.





## DQAP (Quality-Controlled Average)

### Inputs

Input

### Outputs

Average – Computes the quality-controlled average (mean value) of the samples taken during the *Duration*.

STD – Computes the quality-controlled standard deviation of the samples taken during the *Duration*.

Count – Outputs the number of samples that were collected. (The number of samples used in the output average is the Count minus the Outliers)

Outliers – Outputs the number of samples that were greater than three standard deviations from the initial sample mean.

### Description

The DQAP block is a special modification of the Average block. The Average block is a Measure block that can output the maximum, minimum, average, standard deviation, and sample count from a series of data points sampled from a sensor. The DQAP block also computes the average, and outputs it along with the standard deviation and sample count. The difference is in the way the average and standard deviation are computed.

The DQAP block makes use of statistical quality control theory to improve the accuracy of the reported mean and standard deviation. The improvement is obtained by computing the mean and standard deviation in two passes. In the first pass, the mean and standard deviation are determined by the usual process of simply using the collected samples “as is”. After the standard deviation is computed a second pass is made. In the second pass, before a sample is added to a sum, or squared and added to a sum of squares, it is compared to the mean plus or minus three standard deviations. Quality Control (QC) theory indicates that such samples are likely to be in error. An updated mean and standard deviation are computed using only the samples that pass the QC check.

The DQAP block is used to periodically take a number of samples from a sensor and then output the quality-controlled mean, standard deviation, sample count, and number of samples failing the QC check. For example, every half an hour, with a five minute offset, a sensor could be sampled every two seconds for thirty seconds and then the maximum value sampled outputted (see example below).

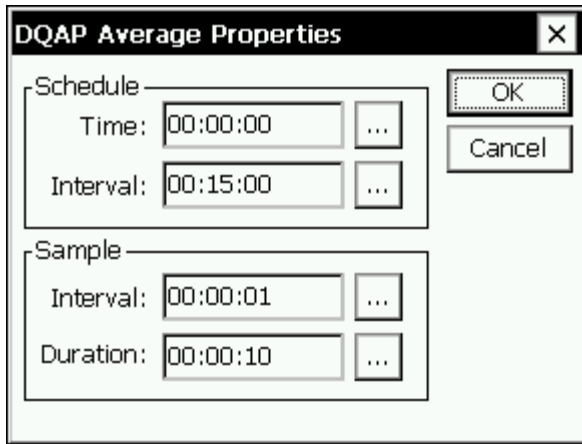

Specifically, the *Schedule Interval* indicates how often the DQAP block should sample a series of data points, process them, and output values. The *Schedule Time* specifies the synchronization of when this should begin. The *Sample Interval* entry indicates how often the sensor should be sampled each time its scheduled to sample and the *Sample Duration* specifies for how long. To average continuously, the *Schedule Interval* should be set equal to the *Sample Duration*.



## Interpolate (Interpolate)

### Inputs

InterIn

### Outputs

InterOut

### Description

The Interpolate block is used to apply a table lookup function to a data stream. This is useful in instances when applying a polynomial function would be too difficult. For values not in the entered table, the output is interpolated from adjoining table entries based on the selected *Method*. The outputted signal can be labeled with new units by clicking the *Units* button.

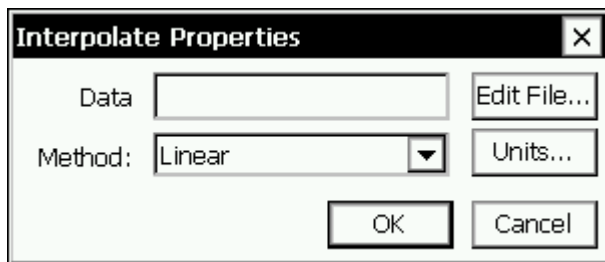

To load, edit or save the file to interpolate from, click the *Edit File...* button. The following window will come up:

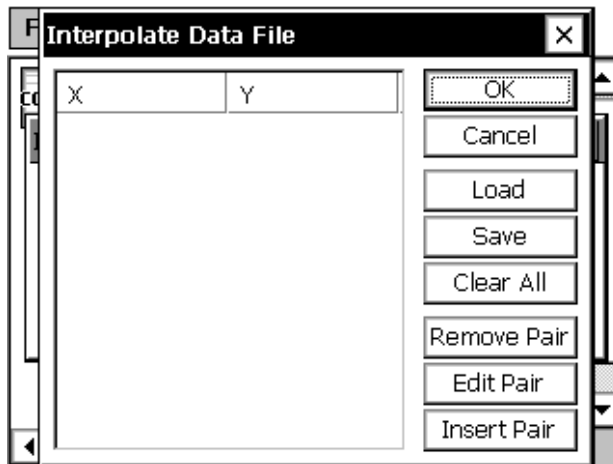

To start creating a new table, use *Insert Pair* to enter pairs of values. The values will automatically sort according to the values in the X column. Any XY pair can be edited or deleted by clicking on that pair and clicking *Edit Pair* or *Remove Pair*. To erase all the entries in the table, click *Clear All*. To save the file or load a previously saved file, click *Load* or *Save*.

For an interpolation table larger than a dozen entries or so, it might be faster to generate it on a PC (with Notepad, for example) and then upload it to the 9210. Files should be created in comma separate format, such as the below example:

```
10.22, 11.55  
12.481, 20.999  
15.0, 40.01
```

The extension of the file should be changed to .tbl before uploading.



## Georgia Pacific Sampler (GPSmpl)

### Inputs

DigIn

### Outputs

DigOut

### Description

This block samples the input (digital) at a user set interval. When the input transitions from low (0) to high (1), increment sampler count and save the time of the event. Then delay for n seconds (user set) and then force measurements of PH1, T1, PH2 and T2. PH1, PH2, T1 and T2 will be set up using standard blocks by tying a COMS TAG to the blocks that make the measurement and convert the value to the desired units. When the measurements are complete append the following record to \storage card\filename.csv in CSV format:

```
Date, time (edge detected), function, splcnt, ph1, t1, ph2, t2
```

Example:

```
08/27/02, 14:03:10, GPSmpl 1, 125, 5.62, 25.19, 9.73, 28.81
```

Use 2 right digits for ph1, t1, ph2 and t2.

If the file does not exist (because a new card has been inserted), create it. If there is a problem creating, opening, or writing to the file, send a warning message to the report.warning.

If the digital input stays at high (1) for more than 5 minutes, write a warning message to the report.warning.

Init splcnt to 0 when recording is turned on.

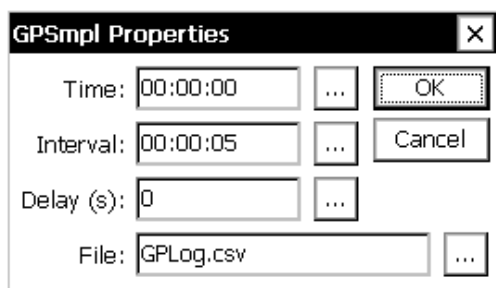



## Measure (Measure)

### Inputs

Input

### Outputs

Output

### Description

Measure blocks are used to create a sampling schedule for sensor blocks. The only time a Measure block (or similar) is not needed after a sensor block is when the sensor block is set to output data based on a specified change on the sensor input (Event mode).

Enter values for the *Time* and the *Interval*. The interval is how often the data from the sensor should be sampled. The time is a synchronization time (not an start time). In the example below, the sensor will be sampled every fifteen minutes, synchronized to the hour. If *Time* had been set to 00:01:00, the sensor would be sampled every fifteen minutes with a one minute offset – if sampling was started at 4:00pm, samples would be taken at 4:16p, 4:31p, 4:46p, etc.

Sensor blocks configured in Event mode do not need to be hooked-up to Measure blocks, but they can be if desired. Doing so will result in data being generated *either* because of a specified change in the sensor input *or* because the next scheduled sampling time has arrived.

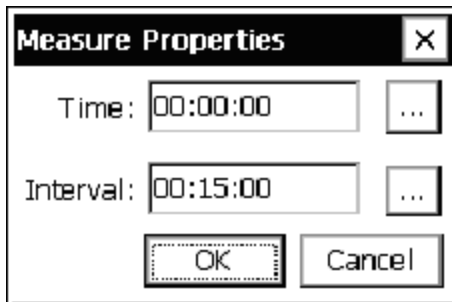

## **Min** **Max** Minimum/Maximum (MinMax)

### Inputs

Input

### Outputs

Min

MinTime (Number of seconds into current day)

Count

Max

MaxTime (Number of seconds into current day)

RMaxVal

### Description

This block outputs its data set at the time and interval defined by the user. The block examines the data received prior to its scheduled interval in order to determine its outputs: the maximum value received, the minimum value received, the time of maximum value, the time of minimum value, and the number of values received. The number from the time outputs is determined by the number of seconds since 00:00:00 of the current day (e.g. a time of 3600, would be 01:00:00).

The block also outputs RMaxVal, which is the value of an optional related item at the time the maximum occurred. This related item is a point in the setup tagged by a ComsTag block. The name of the tag must appear in the “Rel max val” field of the properties dialog. If no tag appears in this field, or if the name is invalid, then RMaxVal is output as 0.

This block is commonly placed after a *Measure* block that is sampling a sensor on a schedule, or directly after a sensor block setup in Event mode. The *Start Time* is an offset time. For example, if the start time below was set to 00:05:00, a measurement would happen at :20:00, :35:00, :50:00, 05:00, etc.

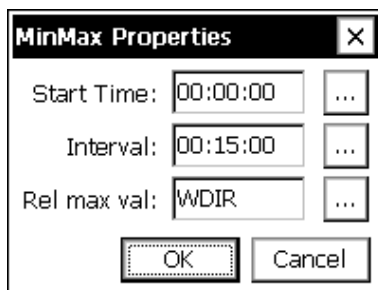



## Moving Average (MovingAverage)

### Inputs

Input

### Outputs

Average

STD

### Description

This block computes a moving average for the input value with each new sample. This differs from the normal Average block that computes the average only at the end of the scheduled interval. It can be used to compute an average speed over a two minute window with the average being updated every second. The screen that follows shows a 10 minute average with the samples being collected every 30 seconds and output of the average every 30 seconds.

When the block runs, the output data will be flagged as bad until  $\frac{1}{2}$  of the required number of samples have been collected.

The checkbox labeled circular input can be used on wind direction sensors where the output is 0-360 degrees. With this box checked, the average will properly compute the average direction even when the sensor changes through 360 degrees.

The *Schedule* fields are used to control when the software reinitializes its computations. The process of re-initialization eliminates computational errors that would otherwise occur. In the following example, the moving average would reinitialize its computations every 12 hours synchronized to midnight.

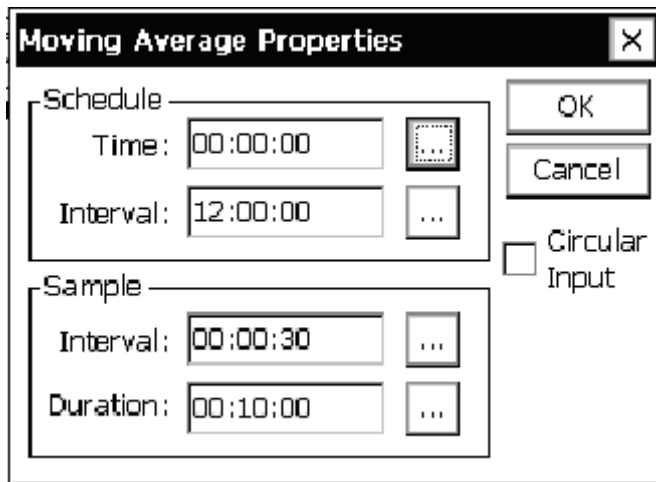





## Polynomial (Poly)

### Inputs

PolyIn

### Outputs

PolyOut

### Description

The Polynomial block is an extremely flexible, general-purpose processing block that can apply a polynomial function in any part of the Setup Diagram data stream. The orders of the desired equation – up to 5<sup>th</sup> order – are entered next to  $k_0$  through  $k_5$ . If the units to be outputted from this block are different from those of the signal that were inputted, those new units can be entered via *Units*.

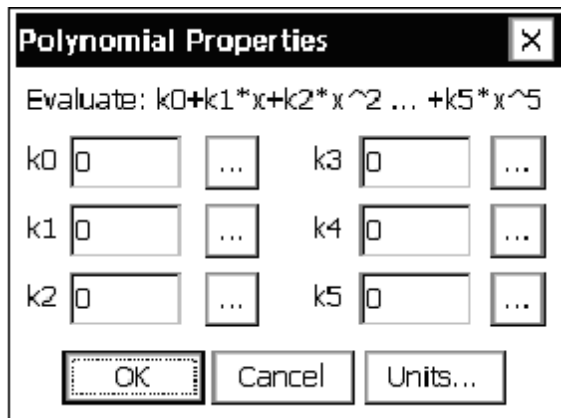

A good use of this block is to generate meaningful values from an unsupported sensor. For example, say there is a humidity sensor that outputs 0.5 to 2.5 volts for 0 to 100% relative humidity (different from the output of any sensors supported by the AT/RH sensor block). The following equation could be determined:

$$y = 50x - 25$$

which would convert the sensor voltage to a relative humidity value ranging from 0 to 100 that could be logged or transmitted.

To implement this in a Polynomial block, the 25 would be entered next to  $k_0$  (for the 0<sup>th</sup> order of the equation) and the 50 entered next to  $k_1$  (for the 1<sup>st</sup> order). Fields  $k_2$  through  $k_5$  would be left at zero since we are only implementing a first order equation. A general-purpose Voltmeter or ADC sensor block would be used to input the sensor voltage into the system in this case.



## PtCtrl (Point Control)

### Inputs

Point

Enable 1

Enable 2

### Outputs

Move +

Move -

Stop

Status

### Description

The Point Control block is used to control the position of some device using a feedback control loop. The current position of the device is “wired” to the input *Point*. When the position of the device differs more than a user-defined amount, the outputs are set to attempt to bring the position of the device back to the desired point.

Point Control Properties

Offset: 00:00:00 ... OK

Interval: 00:05:00 ... Cancel

Pulse Time: 00:00:05:000 ...

Set Point: 10 ...

Deadband: 10 ...

Invert outputs:

Latched outputs:

The control loop executes on a schedule set by the user. The *Offset* and *Interval* properties determine when and how often, respectively, the loop executes. Each is specified in seconds relative to a 24-hour clock.

Both enable inputs must be true for the control loop to execute. When *Enable 1* is false, the control loop skips execution and may execute at the next scheduled interval. However, when *Enable 2* is false, the control loop will no longer be scheduled until recording is restarted, regardless of its subsequent states. Also, when *Enable 2* is false, the Status output is set to false (it is set to true at all other times).

The user sets the desired device position by setting the *Set Point* property. The *Deadband* property defines the range of points that are considered to be within tolerance. Specifically, an

input *Point* is in within tolerance (i.e. no attempt to reposition is made) when the difference between *Set Point* and input *Point* is less than or equal to *Deadband*.

Moves are accomplished by setting the *Move +*, *Move -*, and *Stop* outputs. These are boolean outputs typically wired to *BinOut* blocks in order to set the state of some hardware control line. When *Latched Outputs* is checked, the selected move line is set high for .25 seconds and then set low. After *Pulse Time* seconds elapses, the *Stop* output is set high for .25 seconds, and then set low.

When *Latched Outputs* is not checked, the selected move line stays high for the duration specified by *Pulse Time* before it is set low. The *Stop* output is not set in this case.

The *Invert Outputs* option is used to invert the sense of the control loop. The “normal” sense occurs when the box is not checked. In this case, *Move +* is selected when the input *Point* is **lower** than *Set Point* by more than *Deadband*. *Move -* is selected when the input *Point* is **higher** than *Set Point* by more than *Deadband*. When the *Invert Outputs* option is checked, *Move +* is selected instead of *Move -*, and vice versa.

## Set Point Control (SetPoint)

### Inputs

Level

### Outputs

Control

### Description

This block compares the values coming in on its input with *Set Point* and outputs a 1 or 0 depending if the condition under *Trigger* is met. The *Deadband* allows hysteresis to be added so that the output will not keep change unless the input moves away from the *Set Point* by a meaningful amount.

This block implements a function similar to that of a household thermostat. For example, say we want to output a value of 1 if the input from an Air Temp sensor block crosses 40°C, except that we want there to be a deadband so that the output won't change from 0 to 1 until the input reaches 41°C and the output won't change from 1 to 0 until the output reaches 39°C. We would set *Set Point* to 40, *Deadband* to 1, and *Trigger* to *Above*.

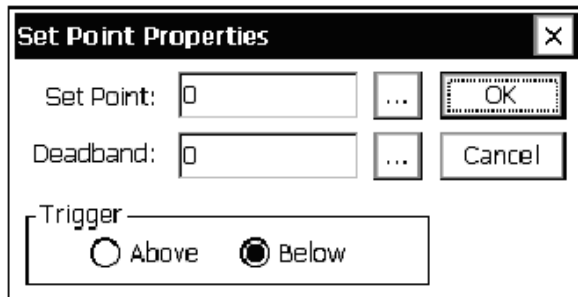

The image shows a dialog box titled "Set Point Properties" with a close button (X) in the top right corner. It contains three main sections: "Set Point" with a text input field containing "0", a browse button "...", and an "OK" button; "Deadband" with a text input field containing "0", a browse button "...", and a "Cancel" button; and "Trigger" with two radio buttons, "Above" (unselected) and "Below" (selected).



## Solar Radiation Accumulator (SRAcc)

### Inputs

SolRad

### Outputs

Accumulation (Accum)

Sunshine (HrsSun)

### Description

This block is designed to do the measurement and processing of data from a solar radiation sensor in order to compute the accumulated value and duration of sunshine. The user set properties of time, interval and sample interval (Smpl Intvl) control the execution of the block. Sample Interval sets how often the block will ask for data from the block connected to it. Typically this block will be a solar radiation block but it can also be a voltage block or any other input\processing block that is not scheduled. The Time and Interval control when the accumulator is reset back to 0. With an interval of 24:00:00 and a time of 00:00:00, the accumulator would be reset every 24 hours at midnight. Hourly resets or resets at times other than midnight are also possible.

The basic computation of the block is:

$$\text{Accum} = \text{Accum} + \text{sample} * \text{smpl\_intvl}/3600 \text{ (smpl\_intvl in seconds)}$$

This calculation is done every Smpl Intvl number of seconds. If the sensor connected to the block has output units of W/m<sup>2</sup>, the output of the block will be WHr/M<sup>2</sup>. So, the block adds the dimension of Hr to the units of sensor it is connected to. You can set the desired units for the output using the Units property field.

The Acc Thrshld (Accumulator Threshold) sets the threshold for accumulating solar radiation data. If the input value is less than this threshold, the data will be ignored. Some sensors have a slightly negative or positive output value in low light conditions. The AccThrshld allows you to ignore this data in the calculation.

The Sunshine calculation computes the amount of time that the input is greater than the hour threshold (hr thrshld). The calculation is simply:

```
If sample>hr_thrshld then
    HrAccum = HrAccum + smpl_intvl/3600 (smpl_intvl in seconds)
```

Hr Thrshld is typically set to 120 (watts/m<sup>2</sup>) as set by the WMO. If your input is in other units, your threshold value will probably be different from 120.

**SoIRad Accumulator Properties** [X]

|              |                                       |                                    |                                       |
|--------------|---------------------------------------|------------------------------------|---------------------------------------|
| Time:        | <input type="text" value="00:00:00"/> | <input type="button" value="..."/> | <input type="button" value="OK"/>     |
| Interval:    | <input type="text" value="24:00:00"/> | <input type="button" value="..."/> | <input type="button" value="Cancel"/> |
| Smpl Intvl:  | <input type="text" value="00:00:05"/> | <input type="button" value="..."/> |                                       |
| Acc Thrshld: | <input type="text" value="0"/>        | <input type="button" value="..."/> |                                       |
| Hr Thrshld:  | <input type="text" value="120"/>      | <input type="button" value="..."/> |                                       |
| Units:       | <input type="text" value="WH/m2"/>    | <input type="button" value="▼"/>   |                                       |



## Vector Average (VectAvg)

### Inputs

Speed

### Outputs

Mean Speed Scalar – This is the scalar wind speed, not taking direction into account. The scalar average of 10mph for an hour and 20mph for an hour is 15mph, regardless of changing direction.

Mean Magnitude Unit – This is the vector average of the wind speed using a unit vector. The mean magnitude unit of 5mph at 0° for 1 hour and 100mph at 180° for 1 hours is 0mph (because two unit vector pointing opposite directions cancel when added with vector addition).

Mean Magnitude Wind – This is the vector average of the wind speed which takes direction into account. Here, the average of 10mph at 0° for 1 hour and 20mph at 180° for 1 hour is negative 5mph.

Mean Direction Unit – This is the wind direction (in degrees) not weighted for wind speed. Here, the average of 10mph at 0° with 20mph at 90° is 45°.

Mean Direction Wind – This is the wind direction (in degrees) weighted for wind speed. Here, the average of 10mph at 0° with 100mph at 90° is 84°.

STD Speed Scalar – This is the standard deviation of the scalar wind speed.

STD Direction Unit – This is the standard deviation of the direction unit.

STD Direction Wind – This is the standard deviation of the direction wind.

Min Speed Scalar – This is the minimum of the scalar wind speed.

Max Speed Scalar – This is the maximum of the scalar wind speed.

Max Direction – This is the direction taken at the time the max speed is detected.

Count – This is the number of samples that have been taken.

### Description

The Vector Average block is a special version of the Average block that includes computations to make a vector average. The vector average is important to any sensor that has a circular discontinuity, such as a wind sensor with the crossover from 0 to 359 degrees. This block is, in fact, geared toward wind sensors, but could be used any time performing a vector average is desired. Like the Average block, Vector Average itself requests samples from a sensor and thus does not require a Measure block to be used before it.

Vector Average has the same properties window as the Average block. See the description of Average for an explanation of the different fields:

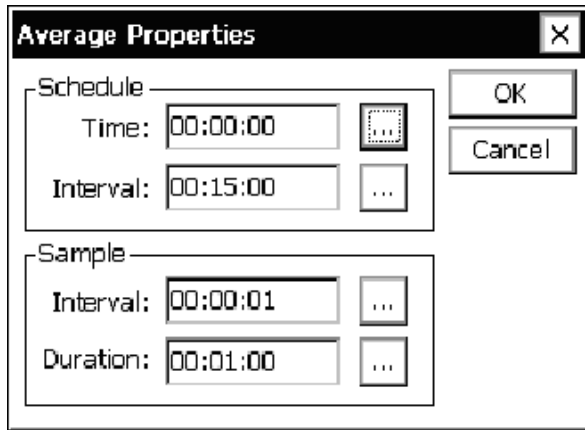

Vector Average has a large number of special outputs corresponding to all the vector computations it makes. To perform most of its computations, the Vector Average block requires signals on both its *Speed* and *Dir(ection)* inputs. These inputs correspond in a general sense to *magnitude* and *angle*, with the angle always specified in degrees.





## Wave Processor (WavProc)

### Input

Input - SDI-12 output from Sutron Radar Stage or Distance values in feet

### Outputs

$T_1$  - mean wave period in seconds

$H_{m0}$  - Significant wave height in meters

$H_{max}$  - Maximum wave height in meters

$T_2$  - Zero-up crossing period in seconds

$T_p$  - Peak Wave period in seconds

$S$  - Wave spectral estimates in  $m^2/Hz$

$F$  - frequency vector in Hz

In addition to the block outputs listed above, the block saves spectral and time-series data to CDIP formatted files, and offers an option to log the outputs in record format.

### Description

The purpose of the block is to process the acquired Sutron Radar Water level data to determine the wave energy spectrum, wave height parameters. The data is collected once a second for 2048 seconds (34 minutes 8 seconds). The data is then processed using industry standard algorithms to produce the mean period, significant wave height, max wave height, zero-up crossing period, peak wave period and spectrum vector.

The processing includes the following steps:

1. Capture 2048 samples of radar data
2. Verify the data quality for any missing data. If there are holes in the data, fill them up using interpolation.
3. Apply detrending filter on the data and obtain final time-domain data.
4. Compute the ensemble-averaged spectral estimate using FFT techniques.
5. Compute the frequency vector.
6. Use wave estimator functions on the spectral estimates and frequency vectors to compute the final output values.

### Configuring the WavProc Block

The following section describes how the Xpert WavProc block is set up for Wave height parameter estimation.

The WavProc block is typically connected to an SDI-12 sensor block configured to measure the Sutron Radar Level Recorder.

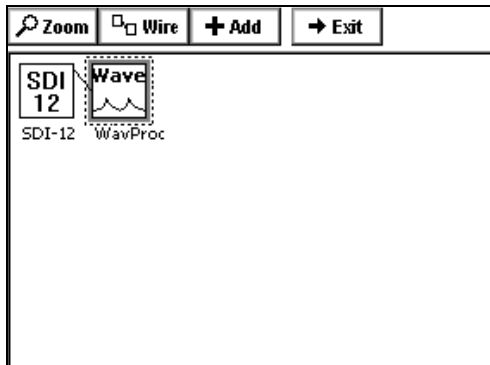

The acquisition characteristics of WavProc block are defined using the **WaveProc Properties** dialog, as seen in the illustration below. The Interval property defines how often to run, and typically should be no less than every hour (01:00:00). The Time property allows you to specify an offset for the interval. Note: sample duration is fixed to 2400 samples, or 34 minutes, 8 seconds.

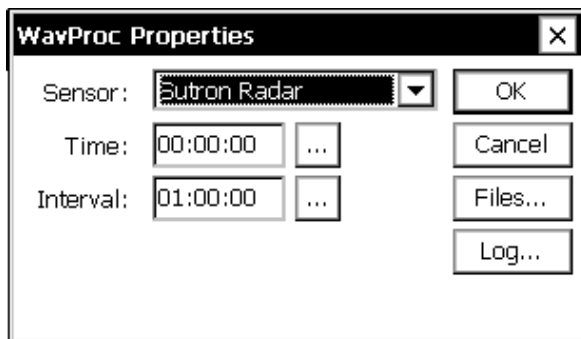

Use the **WavProc Files** dialog to specify where to save the Time-Domain sensor input data and Spectrum domain output data. An archive directory can be defined to host all the data files. Note: the most recent files are overwritten every measurement Interval, whereas the archive directory stores all files generated.

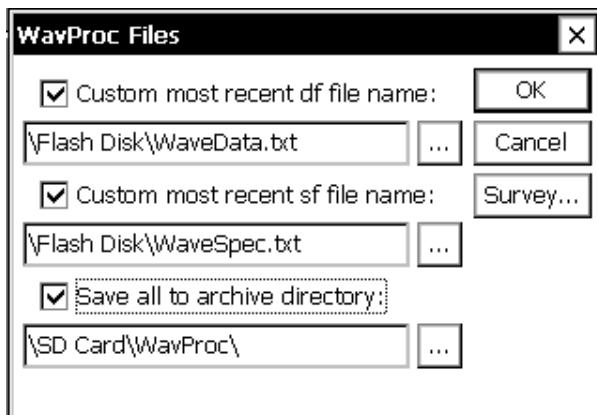

The **WavProc Survey** dialog allows you to define installation site-specific details. These details are included in the input and output data files automatically.

The **WavProc Log** dialog is used to configure record logging. When enabled, output data is logged in the following format:

DateTime,RecordID,T1,Hm0,Hmax,T2,Tp,CenterFrequency,BandWidth,Energy[1],Energy[2],...  
,Energy[16]

## Radar configuration

The Sutron Radar should be configured for 1 second sampling. This can be achieved via the following SDI-12 commands:

```
Automeasure interval: XXS+1+1+1
Operating mode, Average Time and Right Digits: XXS+1+3+1+1+7
Sample Form period: XXS+1+23+1
```

To configure the Radar for 1 second sampling by RS-232, issue the following commands:

```
Automeasure interval = 00:00:01
Operating mode = 1
Average time = 1
Right Digits = 7
Sample form period = 1
```

## Radar SDI-12 measurement

When using an SDI-12 block to acquire Radar data, use an M command to retrieve parameter 1. Be sure to set the correct Address.

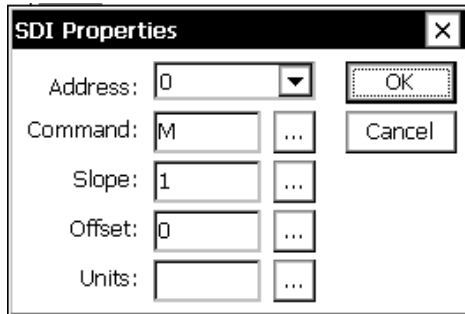

## CDIP-Defined File Format

The block produces the following CDIP defined file format based input and output data files:

1. Spectral data (SP) file
2. Time-series data (df) file

The CDIP file format can be found here:

[http://cdip.ucsd.edu/?nav=documents&sub=index&units=metric&tz=UTC&pub=public&map\\_stati=1,2,3&xitem=product#files](http://cdip.ucsd.edu/?nav=documents&sub=index&units=metric&tz=UTC&pub=public&map_stati=1,2,3&xitem=product#files).

## Sample Spectral Data file

```
=====
File Name: sp07601199801091641      Analyzed(UTC): 2013 06/25 0103 hrs
Station Name: Sutron Sterling Office
Location: 35 12.50 N 120 51.60 W   Sensor Type: Sutron Radar Level Recorder
Water Depth(m): 23 MLLW      Sensor Depth(m): N/A      Sensor Elev(m): 23.0
Shore Normal(deg): N/A      Source File: df07600199801091708
Sample Length(s): 2048      Sample Rate(Hz): 1.0
Hs(m): 1.27 Tp(s): 15.38 Dp(deg): N/A Ta(s): 5.56
```

```
freq      Band      energy
  Hz      width      m*m/Hz
0.015625 0.03125 0.18
0.046875 0.03125 2.75
0.078125 0.03125 0.85
0.109375 0.03125 1.45
0.140625 0.03125 0.90
0.171875 0.03125 1.28
0.203125 0.03125 0.84
0.234375 0.03125 0.56
0.265625 0.03125 1.18
0.296875 0.03125 2.70
0.328125 0.03125 0.21
0.359375 0.03125 2.32
0.390625 0.03125 2.66
0.421875 0.03125 0.41
0.453125 0.03125 2.00
0.484375 0.03125 1.23
=====
```

**Sample Time-series data file**

```
=====
Name: SCRIPPS PIER                               Station: 07301
Channel description: SINGLE POINT
Deployment latitude: 32 52.000' N
Deployment longitude: 117 15.400' W
Water depth(cm):      680
Sensor elevation from sea floor(cm):      230
Data type: Water column (cm)
Gauge type: Sutron Radar Level Recorder
Sample rate(Hz): 1.000
Field software version: N/A
Field station type: N/A
Method of analysis: N/A
Radio modem: no
Energy basin processing: no
Surge filter processing: no
```

```
Number of records: 2048
Start time: 20020201000514 UTC
End time: 20020201011913 UTC
Sample length(hh:mm:ss): 00:34:08
```

```
-----
483.5  483.5  476.1  467.5  462.7  463.6  462.3  465.3
479.1  484.8  480.9  473.5  469.2  473.1  479.1  474.8
462.3  456.7  458.0  465.7  480.0  489.1  483.5  469.2
459.3  463.1  474.8  485.2  485.6  476.1  462.7  452.3
454.9  467.9  483.5  482.6  472.2  467.0  472.2  481.7
483.5  483.5  476.1  467.5  462.7  463.6  462.3  465.3
479.1  484.8  480.9  473.5  469.2  473.1  479.1  474.8
462.3  456.7  458.0  465.7  480.0  489.1  483.5  469.2
459.3  463.1  474.8  485.2  485.6  476.1  462.7  452.3
454.9  467.9  483.5  482.6  472.2  467.0  472.2  481.7
.....
.....
-----
```

## XY Function (XYFunc)

### Inputs

X

Y

### Outputs

Z

### Description

The XY Function block is for doing math between two inputs to produce an output value. The two inputs may be from a single block or from two different blocks. To use a constant in an equation (for example, to perform  $x * 4$ ), use the output from a Constant sensor block as one of the inputs or use the Polynomial block. The *Units* button will set the output data units. If  $x$  and  $y$  inputs have the same units, these units will be retained through to the output.

### Block Placement

XYFunc output should be connected to the input of a measure (or other scheduled block). If you were to connect it after a measure, multiple entries would go into the log, and the most current data would not be used for both X and Y inputs. By placing the measure onto the output, the system will get input data at the same time from both inputs.

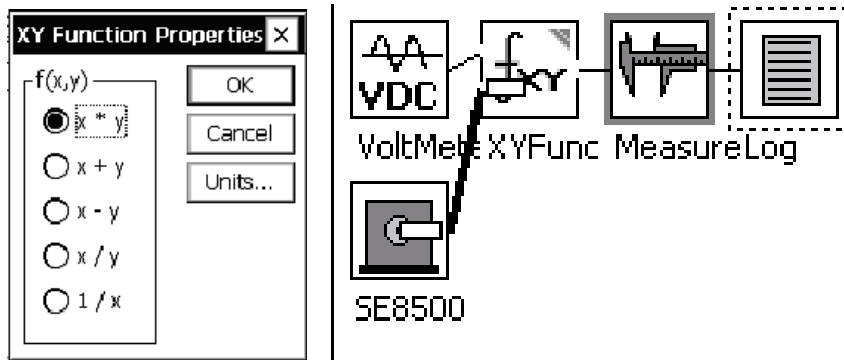

# LOGGING BLOCKS

---

## Log

### Inputs

Input

### Outputs

Output

### Description

This block is used to funnel a data stream into a log file. Generally, one log block is needed for each signal of each sensor that needs to be logged. For example, if temperature and humidity from a AT/RH block needs to be logged, one log block is needed for each. The different log blocks in the system can log to the same log file, different log files, or anything in between.

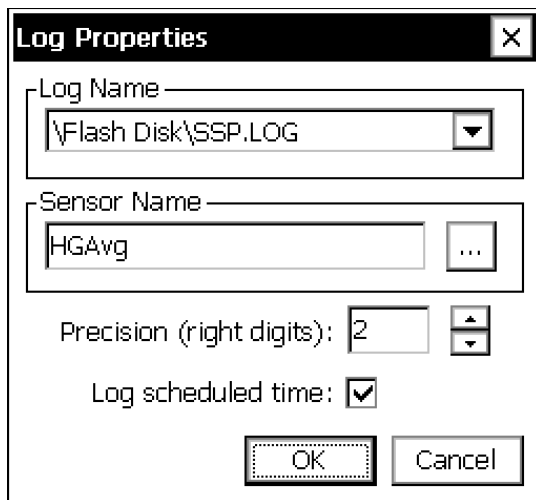

The screenshot shows a dialog box titled "Log Properties" with a close button (X) in the top right corner. The dialog contains the following fields and controls:

- Log Name:** A drop-down menu with the text "\Flash Disk\SSP.LOG" and a downward arrow.
- Sensor Name:** A text box containing "HGAvG" and a browse button (...).
- Precision (right digits):** A text box containing "2" and a spin button.
- Log scheduled time:** A checked checkbox.
- Buttons:** "OK" and "Cancel" buttons at the bottom.

From the *Log Name* drop-down menu, select the log file the data is to be stored to. If the log you wish to use does not yet exist, select the “[New Log]” option from the drop-down list and the system will allow you to create a new log.

*Sensor Name* should be set such that it describes the source of the data. This name shows up in the *Sensor* column of the Log tab and is the only way to identify, for example, whether a temperature data point originated from an AT/RH, AirTemp, BP block.

*Precision* defines the number of places to the right of the decimal point that should be stored in the log. Blocks connected to the output of the log block will get a passed-through version of the data stream seen at the block input, except with the *precision* applied.

*Log scheduled time* determines the source of the timestamp that is given to the logged data. When checked, the data is time stamped with the time the data was scheduled to be measured. When not checked, the time the data is actually finally computed is used. This value may be

several seconds after the scheduled time, depending on how long it takes to measure and calculate the final value.

Logging with actual time instead of scheduled time can be useful when logging min and max values produced by the Average or MinMax blocks. When logging these values with “use scheduled time” unchecked, the timestamp of the data is the same as when the sample was taken that produced the min or max value, as opposed to the time the average, min, and max values are finally computed.



## LogField

### Inputs

Input

### Outputs

Output

### Description

The LogField block works in tandem with the LogRec block to enable you to build a record of data from several fields to add to a log. The LogField block defines the characteristics of one of the fields within the record.

The following shows the Log Field Properties dialog used to configure the Log Field block.

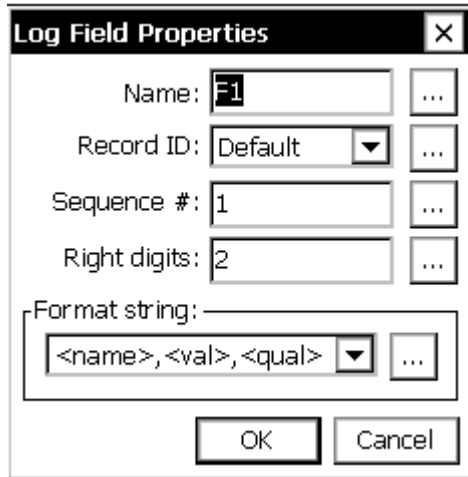

The *Name* property simply gives the field a name that can be included in the formatted output, if desired. The name isn't used for any other purpose. The system creates a default name of "Fx", where "x" is an integer representing the number of fields created so far. Typically, you'll want to name the field something more relevant to its purpose, e.g., "Temp" or "Level", etc.

*Record ID* identifies to which LogRec block this field belongs. The drop-down list allows you to select from all LogRec blocks in the system so far. Or, you can type the name of a LogRec block you intend to create by clicking on the "..." button next to the drop-down. Note that LogField blocks are attached to LogRec blocks by way of Record ID. Hence, if there are two LogRec blocks in the system with the same name, you will see two entries for the name in the drop down list, but selecting either one adds the field to both records.

The *Sequence #* property defines the order in which this field will appear in the logged record. When you press the "..." change button, the system initializes the change dialog with the next available sequence number for the current Record ID.

*Right Digits* specifies the number of places to the right of the decimal point the value logged should have. Note that this applies only to numeric data. If the value being logged is non-numeric (a string), this property is ignored.

The *Format string* property defines what the formatted output will look like in the logged record. The drop-down list provides several different formats to choose from, however, you can specify a custom format string by clicking on the “...” change button next to the list.

The format string combines formatting “tags” with literal characters. Formatting tags are always of the format, “<tag-name>”. The format tags currently supported are “<name>”, “<val>”, “<units>”, and “<qual>”. Whenever the name tag is encountered during formatting, it is replaced with the name of the field. Similarly, the val tag is replaced with the field value, and the qual tag is replaced with the data’s quality flag.

For example, given a field named “Temp” with value (after right digit application) “21.55”, units of “C”, and “good” quality...

| Format string               | Result         |
|-----------------------------|----------------|
| <name>,<val>,<units>,<qual> | Temp,21.55,C,G |
| <name>,<val>,<qual>         | Temp,21.55,G   |
| <name> <val>                | Temp 21.55     |
| “<val> <units>”             | “21.55 C”      |
| <val>                       | 21.55          |



## Inputs

Input

## Outputs

Output

## Description

The LogRec block works in tandem with the LogField block to enable you to build a record of data from several fields to add to a log. The LogRec block defines the characteristics of the record. In addition to disk based logging, the LogRec block also supports FTP and Socket logging. appends the data to a text file on a FTP Server, while Socket logging creates a TCP/IP server that will log the data to any client that connects to it.

The following shows the Log Record Properties dialog used to configure the LogRec block.

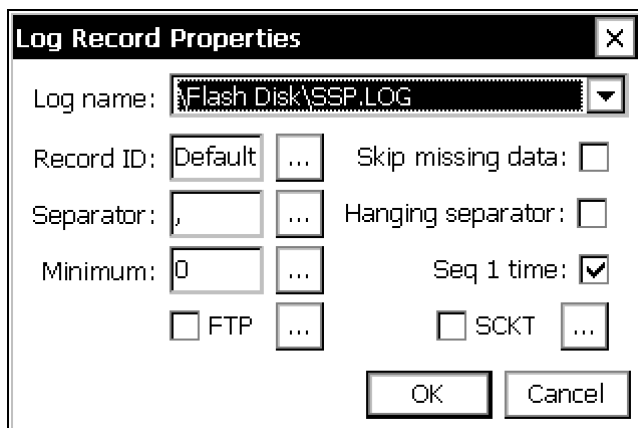

The *Log Name* property identifies to which log the record should be added. The drop down list contains a list of all logs in the system, plus an additional entry that allows you to add a new log. *<None>* may be selected to disable storing the data record to log files.

*Record ID* identifies the name of the record. The name given appears as a selection in all LogField block property dialogs, and is used to identify which fields belong to this record. In addition, Record ID is used to name the record entry in the log.

The *Separator* property defines the string to use in between each field when formatting the record for output to the log.

The *Minimum* property specifies the minimum number of fields that must be formatted into the record before the record will actually be logged.

The *Skip missing data* property determines whether to skip fields whose data has not been updated since the last time the record was formatted and logged. “Skipping” a field means skipping it entirely, meaning the formatted record won’t contain even a placeholder for the data. When this property is not checked, all fields are included in the logged entry, regardless of when

the data was last updated. In this latter case, it's important to make sure all field and record measurement schedules are set up to ensure that field data measurements are complete when the record is computed and logged.

*Hanging separator* determines whether to terminate the formatted output with a separator character. For example, if the property is checked, and the separator character is a comma (','), the logged data will have a comma at its end, as well as between all fields. If the property is not checked, no comma will appear at the end of the logged data. This property is most useful in ensuring the output is compatible with automatic parsing logic used after the log is downloaded.

The *Seq 1 time* property determines what timestamp will be given to the log entry. If the property is checked, the timestamp given is the time of the data in the first formatted field (typically, the field having Sequence # = 1). If the property is not checked, the timestamp given is the time the LogRec block runs (which is typically determined by the schedule of the measure block connected to the LogRec block's output).

When *FTP* is checked, logged data will be appended to a file on a FTP Server. To select the details press [...] and the FTP Logging Properties dialog will be displayed:

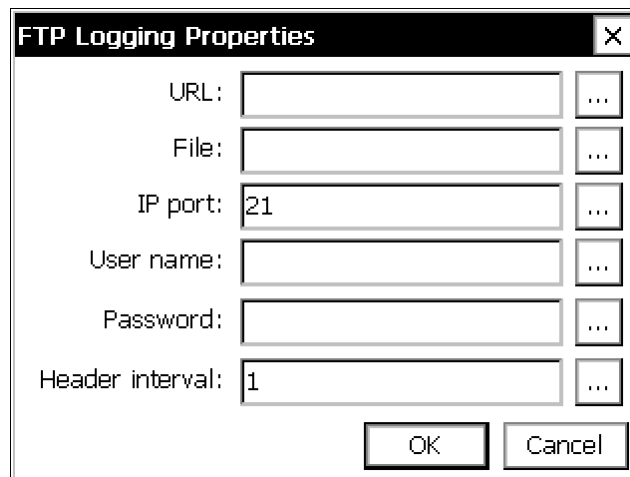

*URL* selects the IP address of the FTP Server and may optionally contain a URL if DNS is available.

*File* selects the name of the file to append the log records, and may contain a path (ex: "/home/loggeddata.csv"). Please note that the file paths on an FTP server typically use the Unix syntax and hence use the forward slash ("/") character as shown in the example.

*IP Port* selects the port number of the FTP Server and is typically 21.

*User name* provides the user name for authenticating with the FTP Server. Only simple authentication is supported.

*Password* provides the password used for authenticating with the FTP Server.

*Header interval* defines how often a header is output in a separate line before the data record (0 for never, 1 for every time, 2 for ever other time, 3 for every third time, etc). The header describes the contents of the data record. As long as the Header Interval is not 0, a new header will be appended after recording has been turned ON to ensure any changes to the setup are reported.

When *SCKT* is checked, a TCP/IP server will be created that will report the record data to any client that connects to it. To select the details press [...] and the Socket Logging Properties dialog will be displayed:

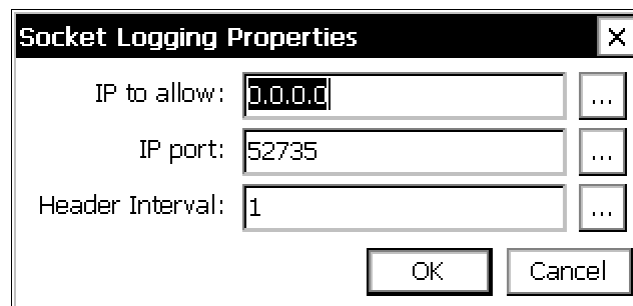

*IP to allow* defaults to 0.0.0.0 which allows any client to connect to the server, any other value will restrict connections to that IP (a URL may not be used in this field).

*IP port* selects the TCP port to be used for connecting to the server, and must not conflict with other TCP ports used by the system (the default value is 52735).

*Header interval* defines how often a header is output in a separate line before the data record (0 for never, 1 for every time, 2 for ever other time, 3 for every third time, etc). The header describes the contents of the data record. As long as the Header Interval is not 0, a new header will be appended after recording has been turned ON to ensure any changes to the setup are reported.



## Inputs

Input

## Outputs

Output

## Description

The WebLog block allows you to place the value connected to the input on the 9210 web page. The 9210 web page is a single page of HTML containing the names and values of interest in the logger. The Sensor Name field sets the name that will be used on the web page and the precision controls how to display the value.

When “Log scheduled time” is checked, the scheduled time of the data value is used as the timestamp of the data shown on the webpage. When “Log scheduled time” is not checked, the actual time the value is computed is displayed (normally, these times are the same; they may differ when measurement delays occur due to loading and/or other factors).

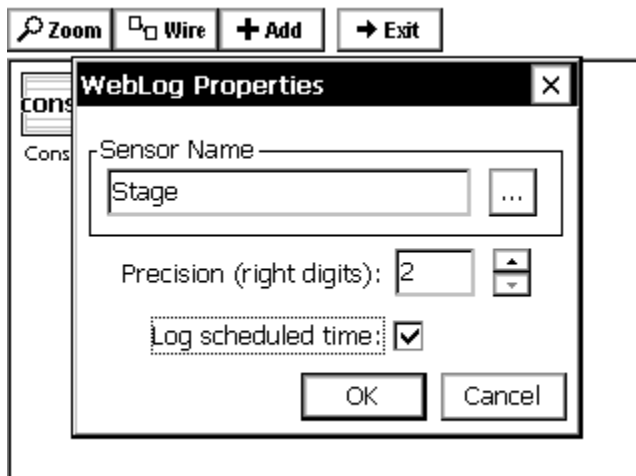

# TELEMETRY BLOCKS

---



## Coms Tag

### Inputs

Data

### Outputs

Data

### Description

This block identifies (or “tags”) data to be shown on the Data tab. .

The Coms Tag block also “tags” information to be included in SSP communications messages. When another station requests “current data”, “alarm data”, “get tag”, “send tag”, or “eval tag” (these are common SSP requests) the 9210 provides the data from the Coms tags. Therefore, you control the data that is included in the responses to these data requests by attaching a Coms tag to the desired data. NOTE: This “tag” is case-sensitive; therefore, it should always be entered in UPPERCASE letters to avoid confusion.

The Prefix and Suffix phrases are only used in speech/voice modem messages. If you do not see choices for the prefix and suffix, the speech files have not been loaded into your 9210.

The Right Digits property controls the precision of the tagged data, but only when the check box is checked.

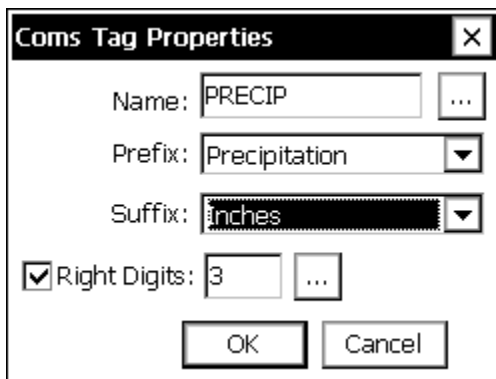

### GUI Placement

If the block is connected to an Alarm block, the Data tab will also show alarm information for the tagged data point.

In order to take live measurements of the sensors, the Coms Tag Coms Tag must be connected after the sensor block, and **before** any Measure, Average, or other active

block (an “active” block is one that initiates a measurement, and typically has a darkened border in the graphical setup). If the Coms Tag is connected after the active block, it will not be able to

retrieve live data. This might be useful when connected to sensors that require time to get data, like SDI-12 sensors, where the intention is to prevent remote users from forcing readings.





## Random Group (RndGroup)

### Inputs

Trigger

### Outputs

Output (pass-through)

### Description

This block defines the alarm conditions for a random transmission group. Its input is typically connected to a sensor that the system is measuring. Each time the sensor is measured and the data is passed to the random group block, the block will check the value for the different type of alarms and trigger an alarm or go out of alarm as determined by the data.

If more than one RndGroup block is used to define a trigger point for the same group, each RndGroup block must have the same DTime, DInter, and Label values. If they differ, the system issues a warning when the setup is saved.

Group lets you assign which random group you are defining the alarm properties for. Label defines the string that will be added to the random transmission to identify the group. Typically, label is a single character such as "2" or "3" (e.g., group number). This field can be any length, but only the first 3 characters are used in the transmit message.

A line is placed into the sensors tab for each random group block in the setup. This line is provided as a way to see the current alarm status of the different groups. If a random group line is selected and measured, or if "Measure All" is pressed, then the random group(s) will pull and evaluate their data. This can result in one or both of the following conditions:

If the random group were placed into the setup after a log block, this would send the data pulled into the log, with the time stamp of when it was measured. If it is desired to not have this data go into the log, the random group should be placed before the log block.

This will also evaluate alarm data before the next measurement. This would be useful when a user is at a site and knows that an event occurred that should trigger an alarm transmission, before the next measurement interval.

### Time and Interval

Time and Interval are used to filter the data to transmit from the data collected by the random parameter blocks, it is not the time and interval of the random transmission. A time of 00:00:00 and interval of 00:15:00 tells the system to use data with times 00:00:00, 00:15:00 ... 23:45:00 when it is time to format and transmit. This allows for the situation where the block is connected to an output that is providing data more frequently than it is being transmitted. It also allows the formatter to identify data that is missing when it comes time to transmit it.

Random Group Properties

Group: 2 DTime: 00:00:00

Label: AT DInter: 00:01:00

Enable Hi Alarm:  Hi Limit: 5

Enable Low Alarm:  Low Limit: 2.5

ROC Fixed Interval:  ROC Mag: 3

ROC Mode: Off Deadband: 1

OK Cancel

The different alarms are:

|                      |  |
|----------------------|--|
| Hi Alarm             | Go into alarm if the input value is $> \text{Hi Limit} + \text{deadband}$  |
|                      | Go out of alarm if the input value is $< \text{Hi Limit} - \text{deadband}$  |
| Low Alarm            | Go into alarm if the input value is $< \text{Low Limit} - \text{deadband}$   |
|                      | Go out of alarm if the input value is $> \text{Low Limit} + \text{deadband}$   |
| Rate Of Change Alarm | <p>1. When ROC Mode is set to Off, no ROC alarm test occurs.</p> <p>2. When ROC Mode is set to Hi, the system goes into alarm if the change in input value is <math>&gt; \text{ROC Mag} + \text{deadband}</math>. The system goes out of alarm when the change in input value is <math>&lt; \text{ROC Mag} - \text{deadband}</math>.</p> <p>3. When ROC Mode is set to Low, the system goes into alarm if the change in input value is <math>&lt; \text{ROC Mag} - \text{deadband}</math>. The system goes out of alarm when the change in input value is <math>&gt; \text{ROC Mag} + \text{deadband}</math>.</p> <p>4. The change in input value is computed in one of two ways, depending on the state of Fixed Interval.</p> <p>If Fixed Interval is checked, the change in input is calculated as the absolute value of the difference between the current value and the last value.</p> <p>If Fixed Interval is not checked, the change in input is calculated as the absolute value of the difference between the current value and the last value that caused a ROC Alarm to occur. Since no alarm has occurred on the start of recording, the first reading taken after the press of START recording (Or power up) is used as the basis to determine ROC alarm, once the unit goes into alarm, the alarm value becomes the basis for the next alarm.</p> |



## Random Parameter (Random)

### Inputs

Input

### Outputs

Output (pass-through)

### Description

This block allows you to include the data from the input in a random satellite transmission. It is most commonly linked to the output of a log block but can also be linked to the output of a measure or average. The Setup tab Random Properties dialog is used to enable random transmissions and define the normal and alarm rate for the transmissions. This block lets you assign the sensor to one of the 8 different random groups (groups 2 .. 9). Each group must have a separate trigger sensor defined by the Random Group block. When the trigger sensor goes into alarm (as defined by the Random Group block, above), the 9210 will make a random transmission of all the sensors assigned to that group. At other times, the 9210 will transmit the data for the different groups according to the setup in the Setup tab. A sensor may be in as many groups as desired.

Along with assigning the sensor to groups, this dialog sets the sequence of the sensor (in the transmission) and the number of values to include in the transmission (BIN-NONINT format). The number of values cannot be set in this dialog if the Random transmission format is set to BIN-INT in the Setup tab.

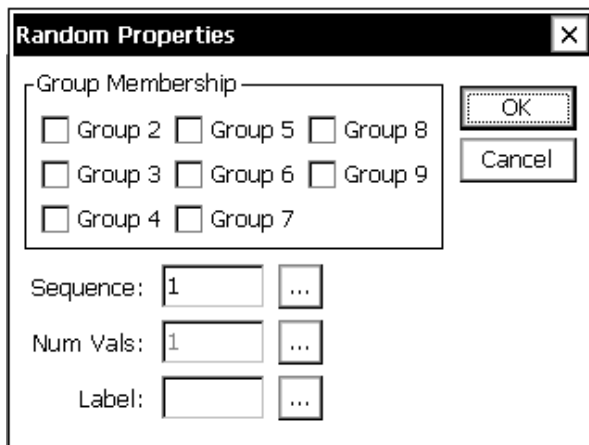



## Self-Timed Parameter (SelfTimed)

### Inputs

Input (the values to transmit)

### Outputs

Output (pass-through)

### Description

This block allows you to include the data connected to the input in a self-timed satellite transmission. It is most commonly linked to the output of a log block, but can also be linked to the output of a measure or average. The properties specify what data to included in the transmission, how many data values and the order of the data.

NOTE: The settings for the transmission format are in the Setup tab under Satlink/Self-Timed. From there, you can select one of the allowed formats including SHEF, SHEFFIX, BIN-INT, BIN-NONINT, NOS, and INSAT. The transmission routines use this selected format and the information in this block to properly format the data.

Self-Timed Properties

Label: AT ...

Data Time: 00:00:00 ...

Data Interval: 00:01:00 ...

Num Values: 8 ...

Sequence: 1 ...

Use calc time:

OK Cancel

### Label

The Label field has multiple uses depending on the transmission format selected. For SHEF and SHEFFIX formats, the value in label is included in the transmission as the sensor ID for the value. The common SHEF IDs are normally simple two letter codes for each sensor such as GH for gauge height, PR for precipitation and so on.

For BIN-INT and BIN-NONINT formats, *Label* is not used, as sensor labels are not included in these format transmissions.

For NOS, the label is used to identify to the formatter the different sensors that must be included in the message. You must put the proper labels for each sensor or the formatter will not be able to locate the sensor to transmit it. The labels are as follows:

Station Datum      **DAT**

|                       |             |
|-----------------------|-------------|
| Sensor offset         | <b>SNS</b>  |
| Primary water level   | <b>WL</b>   |
| Aquatrak sigma        | <b>SIG</b>  |
| Aquatrak outlier cnt. | <b>OUT</b>  |
| Aquatrak temp. 1      | <b>AQT1</b> |
| Aquatrak temp. 2      | <b>AQT2</b> |
| Wind speed            | <b>WS</b>   |
| Wind direction        | <b>WD</b>   |
| Wind gust             | <b>GST</b>  |
| Air temperature       | <b>AT</b>   |
| Water temperature     | <b>WT</b>   |
| Barometric pressure   | <b>BP</b>   |
| Battery voltage       | <b>BAT</b>  |

For NFDRS, the labels tell the formatter how to format the data. The following table shows what labels are recognized by the NFDRS formatter, and how they are formatted.

| Sensor              | Label | Format |
|---------------------|-------|--------|
| Rainfall            | PCH   | xx.xx  |
| 10-Min Avg Wind Spd | USH   | xxx    |
| 10-Min Avg Wind Dir | UDH   | xxx    |
| Air Temperature     | TAH   | xxx    |
| Fuel Temperature    | MTH   | xxx    |
| 10-Min Avg Rel Hum. | XRH   | xxx    |
| Battery Voltage     | VBH   | xx.x   |
| Barometric Pressure | PAH   | xx.xx  |
| Peak Wind Direction | UGX   | xxx    |
| Peak Wind Speed     | UPH   | xxx    |
| Fuel Moisture       | MMH   | xxx    |
| Solar Radiation     | RDH   | xxxx   |

For INSAT, the labels are used to identify the sequence and formatting parameters to use when formatting the message. For each label, an id, offset and scale are associated.

The standard INSAT message encodes the id in an unsigned 4 bit integer, and encodes the data value in an unsigned 10 bit integer. The id is a unique integer from 0 to 19 and is used to determine order (note, however, that since INSAT only uses 4 bits to encode ids, ids appear to start over after 15; this typically requires that decoders consider position, in addition to id).

Encoded values are computed as in the following...

encoded value = ((input data + offset) \* scale + 0.5)

| Sensor   | Label   | Id   | Offset | Scale  |
|--|---------|------|--------|--------|
| Avg. Air Temperature                                     | AT      | 0    | 50.0   | 10.0   |
| Max Air Temperature                                      | ATMax   | 1    | 50.0   | 10.0   |
| Data's integer in id 1,<br>fraction to 3 digits in id 2. | R312    | 1, 2 | 0.0    | 1.0    |
| Min Air Temperature                                      | ATMin   | 2    | 50.0   | 10.0   |
| Soil Temperature   | ST      | 3    | 50.0   | 10.0   |
| Data's integer in id 3,<br>fraction to 3 digits in id 4. | R334    | 3, 4 | 0.0    | 1.0    |
| Avg. Atmospheric Pressure                                | AP      | 4    | -600.0 | 2.0    |
| Relative Humidity  | RH      | 5    | 0.0    | 10.0   |
| Data's integer in id 5,<br>fraction to 3 digits in id 6. | R356    | 5, 6 | 0.0    | 1.0    |
| Net Radiation  | NR      | 6    | 0.0    | 0.25   |
| Data's integer in id 7,<br>fraction to 3 digits in id 8. | R378    | 7, 8 | 0.0    | 1.0    |
| Wind Speed   | WS      | 8    | 0.0    | 10.0   |
| Wind Direction   | WD      | 9    | 0.0    | 1.0/36 |
| Sun Duration   | SunD    | 10   | 0.0    | 0.5    |
| Precipitation Duration                                   | PrecipD | 11   | 0.0    | 0.5    |
| Albedometer (skyward)                                    | AlbIn   | 12   | 0.0    | 0.5    |
| Albedometer (downward)                                   | AlbOut  | 13   | 0.0    | 0.5    |
| Global Radiation   | Global  | 14   | 0.0    | 1.0    |
| Instantaneous Snow Depth                                 | ISD     | 15   | 0.0    | 100.0  |
| Snow Depth   | SD      | 16   | 0.0    | 100.0  |

Offset is the offset of the sensor's range from 0. Scale is the representable range divided by the range of the sensor.

If the label entered is not in the table above, then it is interpreted as an integer to be used as the Id for the data. An Offset of 0 and a Scale of 1 are assumed when encoding the value in this case. This enables new sensor data to be included in INSAT transmissions without having predefined labels. If a different Offset and/or Scale is required, it can be implemented using a Polynomial block connected in-line prior to the Self-Timed parameter block.

## Data Time and Interval

Data Time and Data Interval are used to define which data values coming into the block should be stored for transmission.

For example, a Data Time of 00:00:00 and a Data Interval of 00:15:00 will cause the SelfTimed Parameter block to store any data coming into the block whose timestamp matches those values, i.e., any timestamp in the set 00:00:00, 00:15:00 ... 23:45:00. Similarly, a Data Time of 00:02:59 and Data Interval of 00:06:00 will cause the block to store data whose timestamp falls in the set: 00:02:59, 00:08:59 ... 00:56:59.

Data Time and Data Interval are most useful for when the SelfTimed Parameter block is connected to an output that is providing data more frequently than it is being transmitted. It also allows the formatter to identify data that is missing when it comes time to transmit it.

## Num Values

The SHEF, SHEFFIX, BIN-NONINT, and INSAT formats use Num Values to set the number of values of this sensor to include in the transmission.

NOTE: Setting Num Values in the Setup tab first will provide the default value used when adding new SelfTimed blocks to the setup. This can help reduce the number of edits you must make when creating a setup where the Num Values for each SelfTimed block is the same.

The BIN-INT format only uses Num Values entered in the Setup tab. The value in the SelfTimed block cannot be changed. The NOS format does not use Num Values at all.

When INSAT is the selected format, then when Num Values is greater than 1, previous data is placed into the positions of subsequent ids. For example, when sensor id 2 has a Num Values of 3, the most recent value is transmitted as id 2, the next most recent value is transmitted as id 3, and the next most recent value is transmitted as id 4. Note how this precludes having sensor ids 3 and 4 defined in the setup. If a multiple-position id (e.g., R356) is encountered with Num Values greater than 1, the values are repeated only within the first frame of the message, and only so many times as to ensure complete entries (an orphaned integer entry will not occur).

## Sequence

Sequence is used by the SHEF, SHEFFIX, BIN-INT, and BIN-NONINT formats to define the order of the sensors in the message. It is not used by the NOS and INSAT formats as these have a fixed sequence.

## Use Calc Time

The "Use Calc Time" checkbox is used to specify that the input data's actual time of calculation should be used for all formatting considerations, and not the data's scheduled time. This option is available only when SHEF or SHEFFIX is the current format.

Using the calculated time is useful when the input data is a min or max point from the min-max block. When this is the case, the data point will be collected regardless of the offset and interval property values, and will be formatted with its own label, offset, and interval fields, despite the value of num values. This allows the timestamp of the incoming data to be determined at runtime, and for it to be formatted with an accurate offset field.





# OUTPUT BLOCKS

---



## Binary Out (BinOut)

### Inputs

BinIn

### Outputs

BinOut

### Description

This block is used to control one Digital I/O Module channel's output switch. The switch is either activated (on) or inactive (off). When activated, the switch connects 100 ohms between the channel I/O pin and ground. To configure the block, select the module number, the channel number, and whether or not the output logic should be inverted. The reset/power up state of the digital I/O module is that all the output switches are off. The output switch will also turn off anytime that recording is turned off. Note: Do not use channel 1 or channel 8 for an output.

For more on how Digital I/O Module channels can be used as outputs, see the Appendix C for I/O Modules.

Non-inverted Output States are:

Binary 1 (switch on) = ground

Binary 0 (switch off) = Pull-up to internal +V (depends on channel, see appendix for detailed specs)

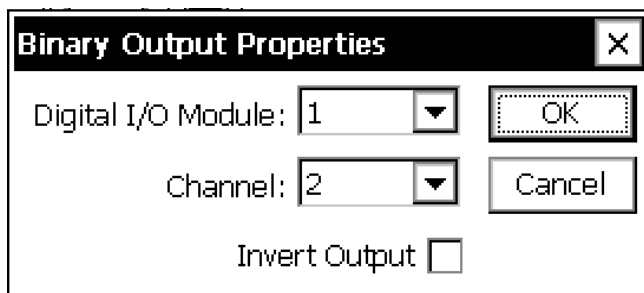



## Pulse Out (PulseOut)

### Inputs

In

### Outputs

Out

### Description

This block is used to generate a pulse on a digital output for a short duration defined by Pulse time. A new pulse will be output each time the block is executed with an input value that is non-zero. The normal state of the digital output pulse will be OFF, ON, OFF. If invert is selected, the pulse will be ON, OFF, ON. Where ON = input grounded, OFF = Pull-up to internal +V (depends on channel, see appendix for detailed specs). Note: any pulse in progress when recording is stopped is terminated, and so may end prematurely.

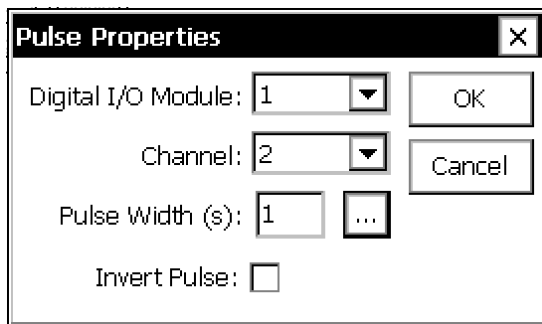

Use the *Digital I/O Module* and *Channel* properties to set the module and channel. Do not use channel 1 or channel 8. Set the width of the desired pulse in the *Pulse Width* property, fractional seconds are accepted (e.g. 0.1).

**NOTE:** If using a digital io module with version 2.03 or earlier, DO NOT use pulses of 1 second or less (e.g. use 1.1 or more). Starting with 2.5, more accurate pulses are used via the modules built-in pulse function. In version 2.03 and earlier, this does not work as it corrupts other channels.



## Send Tag

### Inputs

Data

### Outputs

<none>

### Description

This block will send the current data in the block to another station using Sutron Standard Protocol (SSP) communications. The properties for the block specify the port to use for the communications and the path or station name. The port can be specified only if you have first used the Setup tab COMS (SSP/CL) control and defined some communications ports. The path can be a simple station name or a station with full path information included (such as `\patha\pathb\stationx`). When the Port selection is “TCP/IP”, enter the URL to the destination. The Tag property must match the name specified in a COMS Tag in the named station.

For example, Station 1 is measuring water level and wants to send the water level to Station 2. Add a SendTag block after the measure of the water level in Station 1. Set the Name to WaterLevel and also set the port and path for the link between the two stations. In Station 2, add a COMS Tag and set the name property to WaterLevel. Now, whenever the SendTag block runs, the code will send the water level to the COMS tag block in Station 2.

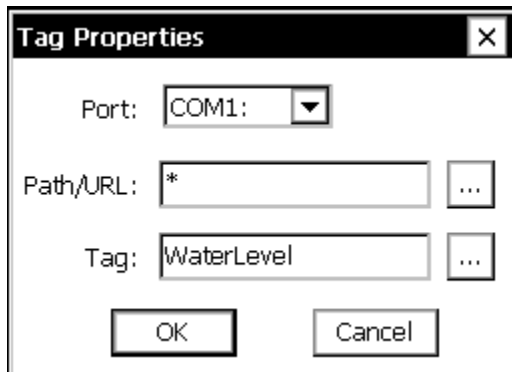

## MISCELLANEOUS BLOCKS

---



### Display (Display)

#### Inputs

Input

#### Outputs

Output

#### Description

The Display block is used select data that gets displayed on the I2C Display. The data displayed is the last measured value for the block connected to the display block. The data is displayed at the requested precision (right digits) with the selected Label.

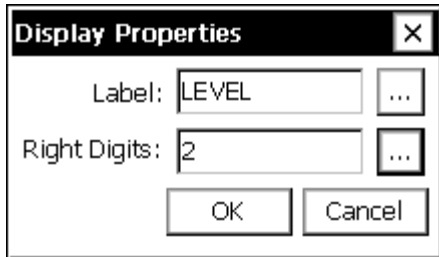

#### GUI Placement

This block can be placed into the setup anywhere data is passing thru. However, if the intended use is to calibrate sensors as well, the block must be connected directly to the sensor block.



## Field Variable (FieldVar)

### Inputs

Input

### Outputs

Output (pass-through)

### Description

The FieldVar block is used to “tag” properties in the setup so that these properties can be changed in the same way as other system “tags” (ComsTags, Basic tags, etc.). System tags can be changed via the Data tab, via a Basic program, via the “set” command, and via SSP command. Note that changing the value of a property is reserved for users having setup access privileges.

The FieldVar block has one input and one output. Connect the output of the target block to the FieldVar input. Viewing the properties of the FieldVar block shows a list of changeable properties of the target block. Below is an example of the FieldVar properties screen when hooked-up to a Measure block.

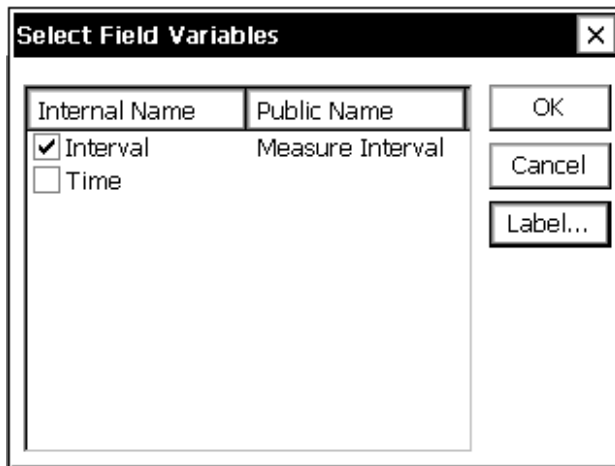

Put a check next to the property you want to tag. Checked properties must have unique *Public Names*. This name defaults to the Internal Name when OK is pressed. The *Public Name* for a property is changed by clicking the property name and then clicking *Label...*

Below is an example of how the Data tab looks when a Measure block has been connected to a FieldVar block with Interval checked and assigned the public name of “Measure Interval”.

|                  |          |         |     |      |        |
|------------------|----------|---------|-----|------|--------|
| Main             | Setup    | Sensors | Log | Data | Status |
| Name             | Value    | Alarm   |     |      |        |
| MEASURE INTERVAL | 00:15:00 |         |     |      |        |
| Refresh          | Meas     | Change  |     |      |        |

# **Appendix B: Updating the Firmware**

## UPDATING THE FIRMWARE

---

From time to time, Sutron will make available new versions of firmware, in order to introduce new features and fix the occasional bug. These updates are typically made available as downloads on the Sutron website ([www.sutron.com/downloads/software.htm](http://www.sutron.com/downloads/software.htm)).

If your system is performing up to your expectations, you may not want to update your firmware, since there is always some risk of introducing a new problem into the system. If you are unsure whether to update your system, and would like to know more about the contents of a particular firmware update (what it adds and what it fixes), contact Sutron Customer Service and request the engineering bulletin for the update.

When new firmware is released, the user upgrades in one of two ways:

Serial/Ethernet Upgrade: Serial cable connected to COM1 on the Xlite and, optionally, ethernet cable connected to DHCP-enabled network.

Storage Card Upgrade: SD or USB flash drive (does not upgrade loader, nor micro monitor).

**WHEN UPGRADING TO v3.8 OR HIGHER FROM v3.7 OR LOWER, YOU MUST UPGRADE THE LOADER!!! SEE, "Upgrade the Boot Loader", BELOW. AFTER UPGRADING THE LOADER, UPGRADE THE APPLICATION AND KERNEL.**

**DO NOT DOWNGRADE TO v3.7 FROM A VERSION HIGHER THAN v3.7 WITHOUT OFFLOADING YOUR DATA FIRST! DOWNGRADING TO v3.7 FROM A HIGHER VERSION WILL RESULT IN A LOSS OF DATA ON FLASH DISK!**

**SD CARDS ARE SUPPORTED. SDHC CARDS ARE NOT YET SUPPORTED.**

### Serial/Ethernet Upgrade

The *Upgrade* button on the right side of the XTerm window is used to start a software upgrade using COM1. The steps to perform this kind of upgrade, are as follows:

77. Download the upgrade from [www.sutron.com/downloads/software.htm](http://www.sutron.com/downloads/software.htm). The upgrade typically comes in a zipped archive, and typically has a name similar to "Xpert2 vX.X.X.X.zip". Once downloaded, unzip the archive onto your PC.
78. Connect your PC to the Xlite using a direct serial cable connection to COM1. Optionally, connect the 9210 to a DHCP-enabled network via ethernet cable.
79. Start XTerm.exe on your PC. To use ethernet (much faster than serial alone), start XTerm from a command prompt, and specify "/LAN" on the command line, e.g., "XTerm.exe COM1:115200 /LAN".
80. Press the "Upgrade" button on the right side of the XTerm window.
81. Select the file "Xpert2 vX.X.X.X.upg" (where X's are replaced by firmware version) in the Open dialog. The upgrade will proceed and finish automatically.
82. The contents of the upgrade file specify what part of the Xlite to upgrade. The parts upgraded may include the loader, kernel, application files, speech files, and custom application files



(SLLs). When Sutron releases a new version of software for the Xlite, the new version is distributed along with a new upgrade file.

83. After selecting the upgrade file, XTerm uses the upgrade file as a script to guide the upgrade process. Dialogs are displayed showing the progress of the upgrade. Occasionally, the upgrade script may cause the Xlite to reboot in order to make changes.

If for some reason the upgrade fails, the process will keep retrying and the last error will be displayed. If it appears the process is not going to complete you have the option to press Cancel and abort the upgrade. At this time you will be prompted if you'd like to view the recent serial port history. If you click yes then you can see what some of the recent messages and prompts issued by the data logger. This can be helpful in determining why the upgrade failed. A longer version of this history is also copied in to the clipboard. If you cannot determine the source of the problem you can edit-paste this information in to an email message explaining the problem and send it to Sutron Customer Service.

### Customizing a Serial/Ethernet Upgrade

Users can make their own upgrade files or edit the ones provided by Sutron depending on individual needs. The upgrade file is a simple ASCII file such that it can be edited with notepad.exe.

An example upgrade file is shown below. To save space, the many steps required to delete all potential custom slls, and to send all possible speech files, have been left out.

```
; The following command tells XTerm this is an Xpert2 upgrade
script.
x
; Reboot Xpert2, bypassing autoexec.bat.
b "bypass"
;
; Remove old programs. If any other files need to be deleted before
the new
; files are deployed, then add them to this list. A typical example
would be
; an sll file you have written for Xpert2.
d "Basic.sll"
d "Coms.sll"
d "DefLib.sll"
d "Engine.dll"
d "Ezsetup.sll"
d "Logger.dll"
d "LogMgr.dll"
d "LZO.dll"
d "Remote.exe"
d "Satlink.sll"
d "SDI.dll"
d "Utils.dll"
d "Xpert.exe"
d "\Windows\Basic.sll"
d "\Windows\Coms.sll"
d "\Windows\DefLib.sll"
d "\Windows\Engine.dll"
```

```

d "\Windows\Ezsetup.sll"
d "\Windows\Logger.dll"
d "\Windows\LogMgr.dll"
d "\Windows\LZO.dll"
d "\Windows\Satlink.sll"
d "\Windows\SDI.dll"
d "\Windows\Utils.dll"
d "\Windows\Xpert.exe"
;
; Send over the standard application files.
s "Basic.sll"
s "Coms.sll"
s "Deflib.sll"
s "Engine.dll"
s "EzSetup.sll"
s "Logger.dll"
s "LogMgr.dll"
s "LZO.dll"
s "Remote.exe"
s "Satlink.sll"
s "SDI.dll"
s "Utils.dll"
s "Xpert.exe"
;
; Send over any extra slls desired. By default, these files are not
sent
; since they aren't used often. See the user manual for
descriptions.
; To send an extra sll, remove the semi-colon that precedes the
command.
p "sll-extra\"
s "GPRS232.sll"
s "NOS.sll"
p ""
;
; Send over default speech files.
m "\Flash Disk\Speech"
m "\Flash Disk\Speech\English"
p "Speech\English\"
s "0.vox" "\Flash Disk\Speech\English\0.vox"
s "1.vox" "\Flash Disk\Speech\English\1.vox"
s "10.vox" "\Flash Disk\Speech\English\10.vox"
p ""
;
; Send the autoexec.bat file over. This file typically starts
remote.exe and
; Xpert.exe after the system boots. When starting remote, it tells
it which
; com ports it should control and how to initialize them.
s "Autoexec.bat"
;

```

```

; Backup the registry in preparation for upgrading the kernel (which
re-inits
; registry, by default). The delay is designed to make sure launch
is finished
; backing up the registry before continuing. Launch automatically
restores the
; registry on its next execution at boot, which occurs after kernel
upgrade.
s "Xpert2.fil"
g "\Windows\Launch.exe" "/BACKUP AutoReg.dat /FILTER Xpert2.fil
/QUIET" " (saving registry)"
h "4" "-" " (saving registry)"
d "Xpert2.fil"
;
; Upgrade the kernel. The upgrade occurs serially, and will take
tens of minutes
; due to the size of the file.
k "Xpert2.ker" "-" " (kernel)"
;
; Upgrade the loader.
l "Xpert2.lod" "-" " (loader)"
;
; Upgrade MicroMonitor. This upgrade is disabled by default. As a
general rule,
; do not enable this step unless directed to do so by someone at
Sutron.
;u "Xpert2.mon" "-" " (umon)"

```

The commands used in the script are:

- p set default source directory
- d delete the specified file
- s send the specified file
- g run the specified executable file on the 9210
- h delay for the specified number of seconds
- u upgrade MicroMonitor
- l upgrade the loader
- k upgrade the kernel
- b reboot

Format of commands:

CMD-LETTER "SOURCE" "DESTINATION" "NOTE"

CMD-LETTER is a single character specifying the command to perform

SOURCE is a quoted string specifying a file to operate on

DESTINATION is a quoted string specifying a file to operate on

NOTE is a message that will be displayed in the progress bar

Unused parameters at the end of a command may be omitted. Blank quoted strings are not allowed, use "-" if you wish to skip a parameter, but include a later one. If the default source directory is not provided, the directory where the upg file is located is used.

## Storage Card Upgrade (SD or USB)

This method offers the benefit of speedy application and kernel upgrades, but cannot be used to upgrade the loader or micro monitor. Hence, this method should only be used when it is clear no upgrade of the loader or micro monitor is needed.

The steps to perform this kind of upgrade, are as follows:

84. The upgrade typically comes in a zipped archive, and typically has a name similar to "Xpert2 vX.X.X.X SCzip" (SC in this case is meant to signify "storage card"). Once downloaded, unzip the archive onto an SD or USB card installed in your PC.
85. Alternatively, if the SD or USB card is not installed in your PC, but is instead installed in the Xlite, you may choose to:
86. Unzip the archive to your PC.
87. Use the command line interface to create the same directory structure on the storage card as exists in the unzipped archive.
88. Copy the contents of each unzipped archive directory to the corresponding storage card directory.
89. Alternatively, if you do not want to use a storage card, and you have at least 10MB available on the Xlite flash disk, you may choose to copy the unzipped archive to the \Flash Disk. You'll need to create the directory structure first using the command line interface in this case as well.
90. Insert the storage card into the Xlite (skip this step if you chose option b, above).
91. Select the "Upgrade Kernel and/or Application" option from the Setup tab.
92. The system will prompt you whether you want to upgrade using the upgrade found. Verify the upgrade found is the one you intended and select "Yes".
93. If the upgrade includes the kernel (true when the upgrade provides the file "Xpert2.ker" in the root of the upgrade archive), the system will prompt whether you wish to backup the registry. Answer "Yes".
94. The upgrade will begin and finish automatically, and may involve a reboot.

## Customizing a Storage Card Upgrade

Upgrading using an SD or USB file in the manner described above uses an upgrade script file (text having "upg" extension) that is very similar to the one used when upgrading serially. The following commands are supported:

- p set default source directory
- d delete the specified file
- s send the specified file
- m make the specified directory (e.g., m "\Flash Disk\Speech")
- r rename specified file (e.g., r "\Flash Disk\DefLib.sll" "\Flash Disk\Deflib.bak")

## Manual Component Upgrade

Individual firmware components can be upgraded using a variety of methods other than those listed above. This section describes a few of those methods.

Be careful upgrading individual components of Xlite firmware because of incompatibilities across different versions. The set of files contained in a single download archive from the website are all compatible. As a general rule, don't mix with other versions, unless specifically told to do so by Sutron customer service.

### Upgrade the Boot Loader

The Xlite boot menu provides the ability to upgrade the Xlite boot loader, either by serial or ethernet transfer.

95. Download either the serial or storage card upgrade from the Sutron website, at the following address: [www.sutron.com/downloads/software.htm](http://www.sutron.com/downloads/software.htm). The upgrade typically comes in a zipped archive, and typically has a name similar to "Xpert2 v3.0.zip". Once downloaded, unzip the archive onto your PC. The boot loader is stored in the file "Xpert2.lod".
96. Start hyperterm or other terminal program on a PC. Set the baud rate to 115,200. Connect the COM1 serial port to the Xlite. If you intend to transfer the boot loader file via ethernet, connect the Xlite to a network that supports DHCP using an ethernet cable.
97. Power up the Xlite. Press ESC in response to the message "Press ESC now to Upgrade System".
98. Press "L" to indicate you want to transfer the boot loader.
99. Press "U" to indicate you want to upgrade the boot loader.
100. Use the menus that follow to specify either a transfer via ymodem or ethernet, and follow the instructions to send the file Xpert2.lod, downloaded in step 1.
101. After the upgrade is complete, reboot the Xlite.

### Upgrade the Kernel

The Xlite boot menu provides the ability to upgrade the Xlite kernel, either by serial or ethernet transfer.

102. Download either the serial or storage card upgrade from the Sutron website, at the following address: [www.sutron.com/downloads/software.htm](http://www.sutron.com/downloads/software.htm). The upgrade typically comes in a zipped archive, and typically has a name similar to "Xpert2 v3.0.zip". Once downloaded, unzip the archive onto your PC. The kernel is stored in the file "Xpert2.ker".
103. Start hyperterm or other terminal program on a PC. Set the baud rate to 115,200. Connect the COM1 serial port to the Xlite. If you intend to transfer the kernel file via ethernet, connect the Xlite to a network that supports DHCP using an ethernet cable.
104. Power up the Xlite. Press ESC in response to the message "Press ESC now to Upgrade System".
105. Press "K" to indicate you want to transfer the kernel.
106. Press "U" to indicate you want to upgrade the kernel.
107. Use the menus that follow to specify either a transfer via ymodem or ethernet, and follow the instructions to send the file Xpert2.ker, downloaded in step 1.
108. After the upgrade is complete, reboot the Xlite.

## Upgrade the Application

The Xlite application (Xpert.exe and associated dlls and slls, as well as remote.exe) can be upgraded using the steps outlined in this section. Use great caution here, as mixing different versions of slls and dlls can cause very strange, hard to diagnose, behavior.

109. Download either the serial or storage card upgrade from the Sutron website, at the following address: [www.sutron.com/downloads/software.htm](http://www.sutron.com/downloads/software.htm). The upgrade typically comes in a zipped archive, and typically has a name similar to "Xpert2 vX.X.X.X.zip". Once downloaded, unzip the archive onto your PC. The Xlite application consists of Xpert.exe, all dll files (\*.dll), and all standard sll files (those files with \*.sll extension that do not appear in the "extra sll" directory). Of course, you may also use one or more sll files in the extra sll directory.
110. Start hyperterm or other terminal program on a PC. Set the baud rate to 115,200. Connect the COM1 serial port to the Xlite. If you intend to transfer files via ethernet, connect the Xlite to a network that supports DHCP using an ethernet cable.
111. Power up the Xlite. Press Ctrl-C in response to the message "Press Ctrl-C to skip execution of Autoexec.bat". You should then see "Bypassing \flash disk\Autoexec.bat, running Remote" in the next few lines. If you do not, simply repeat this step until you do.
112. If you intend to use ethernet and the ethernet port lights are off, issue the command "lanon". If you intend to perform serial transfers, close the terminal program. In any case, run XTerm and connect to the Xlite.
113. Press the XTerm "File Transfer" button on the right of the XTerm display. This will bring up a dialog showing a list of Xlite files in the right pane, and a list of PC files in the left pane. Make sure the right pane is showing files in the "Flash Disk" subdirectory.
114. Change the directory in the left pane to the directory containing the upgrade files, and select the files you want to send to the Xlite (note: you can select multiple files by holding down the Ctrl key with each new selection).
115. Press the ==> button to transfer the files to the Xlite. Press OK to start the transfer and wait for the transfer to complete.
116. When finished, reboot the Xlite.
- 117.
- 118.
119. NOTE: Xpert app now contains some additional checks to ensure the correct version of ssl/dll is loaded. If the app detects an incorrect version, it WILL NOT load that sll/dll. If this happens, a warning message is shown on boot-up and a warning message will be placed into the system log indicating what version was found and what is expected. If this happens, simply copy the correct version of dll/sll onto the flash disk and re-boot the unit.

# **Appendix C: I/O Modules**

## XLITE ANALOG MODULE – “A” TERMINAL STRIP

The connections for the A terminal strip are as follows:

|            |   |
|------------|---|
| AGND       | Analog Ground   |
| CH1        | Input channel 1 (1+ or 2-)  |
| CH2        | Input channel 2 (1- or 2+)  |
| AGND       | Analog Ground   |
| CH3        | Input channel 3 (3+ or 4-)  |
| CH4        | Input channel 4 (3- or 4+)  |
| VREF       | 2.5V Reference voltage  |
| AGND       | Analog Ground   |
| CH5        | Input channel 5 (5+ or 6-)  |
| CH6        | Input channel 6 (5- or 6+)  |
| AGND       | Analog Ground   |
| VREF       | 2.5V Reference voltage – only on during analog measurements performed by the built in AIO module (AIO1) |
| AGND       | Analog Ground   |
| CH7        | Input channel 7 (7+ or 8-)  |
| CH8        | Input channel 8 (7- or 9+)  |
| AGND       | Analog Ground   |
| CH9        | Input channel 9 (9+ or 10-) *CANNOT BE USED FOR EXCITATION  |
| CH10       | Input channel 10 (9- or 10+) *CANNOT BE USED FOR EXCITATION   |
| AGND       | Analog Ground   |
| VEX        |   |
| PWR IN GND |   |
| PWR IN +12 |   |

(input numbers in parenthesis are for differential measurements)

Features:

Ten inputs configurable as 10 single ended channels or 5 differential inputs or a combination of single ended and differential inputs.

16 bit resolution (Slow mode, Gain =1)

Maximum Sample rate – All channels once per second (fast mode).

Continuous self-calibration

One excitation voltage (2.5V)



Multiple sampling rates and digital filtering

Capability to internally read the battery voltage.

External Bridge Completion resistor needed for resistance measurements.

External Sense resistor needed for current measurements.

| Parameter                         | Min  | Typ | Max  | Units |
|-----------------------------------|------|-----|------|-------|
| <b>Analog Input</b>               |      |     |      |       |
| Measurement Range<br>Single ended | 0    |     | 5    | Volts |
| Measurement<br>Range Differential | -2.5 |     | 2.5  | Volts |
| Voltage Input Range               | 0    |     | 5    | Volts |
| Resolution <sup>1</sup>           | 16   |     |      | bits  |
| Absolute Error                    |      |     |      |       |
| 25 °C                             |      |     | 0.02 | %FS   |
| -40 to +60°C                      |      |     | 0.1  | %FS   |
| Ratiometric Error <sup>2</sup>    |      |     | 0.01 | % FS  |

**Note: Each of the differential input terminals must stay within the voltage input range. The differential range is with respect to the other member of the differential pair.**

## XLITE DIGITAL MODULE – “B” TERMINAL STRIP

The connections for the B terminal strip are as follows:

|             |  |
|-------------|--|
| GND         |  |
| IN HF 1     | Channel for frequencies up to 8KHz. Cannot be used for tipping bucket, digital inputs or shaft encoders. |
| I/O 2       | Standard I/O channel   |
| GND         |  |
| I/O3        | Standard I/O channel   |
| I/O4        | Standard I/O channel   |
| GND         |  |
| I/O5        | Standard I/O channel   |
| I/O6        | Standard I/O channel   |
| GND         |  |
| I/O LL 7    | I/O channel with programmable level  |
| GND         |  |
| IN LL 8     | Input only channel with programmable level   |
| GND         |  |
| SW'D 12     | Switched 12 (Battery / protected with self-resetting fuse, 500 mA max)                                   |
| GND         |  |
| PROT 12     | Protected 12 (protected with self-resetting fuse, 500 mA max)  |
| RS485A      | Idles High (Standard RS-485 nomenclature this would be B)  |
| RS485B      | Idles Low (Standard RS-485 nomenclature this would be A)   |
| SDI-12 GND  | SDI-12 Connections   |
| SDI-12 +12V | SDI-12 Connections (protected with self-resetting fuse, 500 mA max)                                      |
| SDI-12 DATA | SDI-12 Connections   |

**Note:** The 9210 provides a very weak bias to maintain the RS-485 idle condition. If the connecting device is expecting strong bus biasing, then external biasing resistors can be added: one resistor between the RS485B and GND terminals with a second resistor between RS485A and PROT 12 terminals. For mild biasing, use 100K resistors. For much stronger biasing, use 10K resistors.

## Features

Eight digital I/O lines, CMOS level inputs. Six bi-directional, two input only.

Up to eight counters/frequency inputs with programmable alarm. Seven that count leading edge, trailing edge or both edges of input pulse. One channel of frequency input up to 8 kHz

Up to three quadrature shaft encoder inputs (requires two inputs per sensor) with programmable alarm

Two switchable threshold inputs compatible with R M Young wind sensor.

| Parameter                       | Min | Typ | Max | Units        |
|---------------------------------|-----|-----|-----|--------------|
| Inputs                          |     |     |     |              |
| Inputs                          |     |     |     |              |
| Sampling Interval               |     | 500 |     | Microseconds |
| Switchable threshold            | .02 |     | 2.5 | Volts        |
| Output(open drain MOS switches) |     |     |     |              |
| Pull-up voltage                 | 0   |     | 15  | Volts        |
| Resistance                      | 80  |     | 125 | $\Omega$     |
| Current                         |     |     | 70  | mA           |

## Inputs

When programmed as an input, each line can act as a digitally filtered counter clock or a shaft encoder input (do not use channels 1,2 for a shaft encoder). Shaft encoders require two input lines, hence, users can have up to three shaft encoders, eight counters, or a combination of the two. When a run command is received, sampling of the inputs starts. The Digital I/O reads the inputs when it gets a run command and uses these values for the initial state of the filter.

Input states are 0V = binary 0 and >2.5V = binary 1

Channels 7 and 8 are different from channels 1-6 because of their ability to work with low level signals (150 mv threshold, high sensitivity) or high-level signals (2.5V threshold, low sensitivity).

Channels 1-6 have a 100K pull-up to +5 through a diode. Channels 7 and 8 have a 1meg Ohm pull-up to 2.5V. As a result, you will only see around 2.25volts on channels 7 and 8 with nothing connected. The threshold for detecting a binary 1 vs. a binary 0 is at 2.5 volts. Therefore, Channel 7 and 8 may not be at a 1 with nothing connected and it may not change its state when you ground it, unless an external pull-up resistor between channel 7 or 8 to +5 (or +12 if connected device can handle it) is added. This will make these channels act more like the other channels. This will affect any sensor with an open-collector arrangement, or a simple mechanical switch.

Channel 1 cannot be used as a digital status input or tipping bucket input because of the divide-by-8 circuit on the channel.

### **Digital filters**

The inputs can be low pass filtered before being applied to counters. Shaft encoders are not filtered. The digital filters are up-down counters that count between 0 and a user defined threshold value. Each input line's filter can have a different threshold value. The input to a filter is one of the eight input lines, the output feeds a 32-bit counter. The filter counts up at each sample interval when its input is a one and down when its input is a zero. The counter will not count up if it is at its upper threshold, and it won't count down when its count is zero. The output of the of the filter only changes state when the counter reaches zero or its upper threshold. Thus, if the output state of the filter is a one, it will stay a one until the counter reaches zero. It will then remain zero until the counter counts up to its upper threshold. Valid digital filter time constants are 1 to 255.

### **Counters**

Up to eight 32-bit counters can be programmed to count on both edges or just the positive-going edge of their respective inputs. Since the input to the counter can be inverted under program control, the counter can also be made to count on the negative going edge by inverting its input. The counter alarm message can be set to be sent after 1 to 255 counts.

### **Frequency**

The time is logged for each counter every time it counts. This time is reported for each counter when the counters are read. Frequency can be measured by reading the counters twice and computing the difference in time and counts.

Channel 1 has a special divide by 8 circuit to allow the measurement of frequencies up to 8 KHz.

### **Shaft encoders**

Up to three Quadrature shaft encoders may be set up. The input lines must come from adjacent inputs starting with an odd numbered one (e.g.: 3,4; 5,6; 7,8). Each shaft encoder has a 32-bit counter associated with it. It counts up for one direction of rotation and down for the other.

### **Outputs**

Each of the six lines (I/O2..I/O7) with output capability can be turned on or off under control of the setup. Any output can be pulsed using the pulse output block.

When configured as an output, the internal circuitry is actually providing a path to ground through a 100ohm resistor when turned on (binary 1) and pulled up through internal pull-up resistors when turned off (binary 0), see INPUTS section if using channel 7 or 8 for details.

The maximum current draw is 70mA, trying to sink more current than this will cause damage to the channel.

## ADD ON ANALOG I/O MODULE – 8080-0003

---

The 8080-0003 Analog I/O Module (ADC) can be added onto the 9210 to expand its analog input capability. The module has six analog I/O lines, an output that can be switched to ground and switched and unswitched 12 volt outputs. The analog lines are capable of being inputs and outputs simultaneously giving the user tremendous flexibility in setup. As an example, the simple resistance measurement is made by exciting the input the resistor is connected to and measuring the current and voltage on that input line just as would be done using a conventional multimeter.

### Features

Six inputs configurable as 6 single ended channels or 3 differential inputs or a combination of single ended and differential inputs. All channels feature self-excitation and built-in voltage, current and resistance sensing.

Input gain settings 1, 16

Up to 6 4-20ma sensor interface

24 bit analog to digital converter

Continuous self-calibration

Vout (excitation) return for maximum common mode rejection of bridge sensors

One switched battery sensor power output

Industrial temperature range operation  $-40$  to  $+60^{\circ}\text{C}$

Multiple sampling rates and digital filtering

Ability to make resistance measurements without additional external resistors.

Viewing the card from the front, the plug assignments are as follows:

|   |         |   |         |   |         |   |         |   |         |         |      |     |        |    |    |     |       |
|---|---------|---|---------|---|---------|---|---------|---|---------|---------|------|-----|--------|----|----|-----|-------|
| 1 | 2       | 3 | 4       | 5 | 6       | 7 | 8       | 9 | 10      | 11      | 12   | 13  | 14     | 15 | 16 | 17  | 18    |
| G | 1<br>1+ | G | 2<br>1- | G | 3<br>3+ | G | 4<br>3- | G | 5<br>5+ | 6<br>5- | Aux1 | -EX | N<br>C | G  | G  | Bat | SwBat |

G = Ground

Bat = 12 volts out

SwBat = switched 12 volts out

Aux1 = switch to ground

-EX = negated excitation voltage

NC = No Connections

Differential channel pairs are 1-2, 3-4, 5-6. The higher voltage line goes to the odd line.

## Specifications

| Parameter                                   | Min  | Typ | Max    | Units            |
|---|------|-----|--------|------------------|
| <b>Input</b>                                |      |     |        |                  |
| Range                                       | -5   |     | 5      | Volts            |
| Absolute Error<br>25°C                      |      |     | 0.0015 | %FS <sup>5</sup> |
| -40°C to +60°C                              |      |     | 0.03   | %FS <sup>5</sup> |
| Ratiometric Error <sup>1</sup>              |      |     | 0.0015 | %FS <sup>5</sup> |
| CMRR  |      | 70  |        | dB               |
| 60Hz Rejection                              | 100  |     |        | dB               |
| Rin   |      |     |        |                  |
| Single Ended                                | 20   |     |        | Meg Ω            |
| Differential                                | 20   |     |        | Meg Ω            |
| Common Mode                                 | 20   |     |        | Meg Ω            |
| Filter Range                                | 10   |     | 2000   | Hz               |
| <b>Excitation</b>                           |      |     |        |                  |
| Range                                       | -5.0 |     | +5.0   |                  |
| Output Current                              |      |     | 10     | mA               |
| Output Impedance                            |      | 110 |        | Ω                |
| Absolute Error<br>25°C                      |      |     | 0.0015 | %FS              |
| -40°C to +60°C                              |      |     | 0.03   | %FS              |
| Ratiometric Error <sup>2</sup>              |      |     | 0.005  | %FS              |
| Frequency                                   | 0    |     | 10     | Hz               |
| <b>Sensor Power (VBAT from Data Logger)</b> |      |     |        |                  |
| Voltage                                     | 9    |     | 14     | Volts            |
| Current                                     |      |     | 100    | mA               |
| <b>Protection</b>                           |      |     |        |                  |
| Static Discharge <sup>3</sup>               |      |     | 2000   | Volts            |
| Conducted <sup>4</sup>                      |      |     | 400    | Volts            |

<sup>1</sup>Error which will not cancel when two measurements are expressed as a ratio.

<sup>2</sup>The excitation outputs are connected internally to the analog to digital converter. This value is the accuracy of this measurement. Available voltages are the integer values between -5 and +5 V.

<sup>3</sup> Human body model.

<sup>4</sup> One microsecond rise, one milli-second fall.

<sup>5</sup> Channel 1, Differential over -4.8 to 4.8 Vin

## Operational States

The ADC has two operational states - *running* and *stopped* - which are controlled by commands to the device.

### Running

In this state, the input lines are sampled and processed. This state consumes more power than the stopped state, so the ADC card should be left running only if necessary. The digital output line may be pulsed using the pulse command. The ADC executes a reset sequence when it receives the run command. When the reset is complete, a message is sent to the host.

### Stopped

In this state, the device is idle. It will accept commands, and the output Aux1 will reflect the last command that set this output to either open (1) or switched to ground (0). The input lines are not sampled. Pulse commands will be ignored in this state.

## Inputs/Outputs

### Inputs

The ADC has six single ended analog inputs which may be paired to form differential inputs.

### Outputs

The ADC provides:

- One 12-volt output (Bat)

- One switched 12-volt output (SwBat)

- One output that can be switched to ground (Aux1)

- Six excitation channels (analog outputs) that can be programmed from  $-5V$  to  $+5V$ , and,

- One output  $-Ex$  which is always the negative of the current excitation voltage value.

The excitation channels are shared with the input lines. Only one excitation channel can be active at a time. The negative of this voltage provided on  $-Ex$  can be useful in balanced bridge applications to minimize common mode voltage.

The output Aux1 provides a switched path to ground that, when closed, grounds through a 100-Ohm resistor. The state of this output may be pulsed using the pulse command. It may be pulsed open or closed. If the output is already in the state that the pulse command requests, nothing will happen. The ADC device must be in the running state to pulse Aux1.

The board must be in the running state to switch the SwBat on. This will turn off if the device goes to the off state.

## Analog Measurements

The ADC can measure voltages on its terminals and across internal sense elements. Sense element voltages allow currents to be calculated by a host processor. The ADC can also take paired terminal voltage and sense element voltage measurements that can be used to compute resistance values.

The ADC has a built-in low pass filter for noise rejection that is programmable for a 10 to 1900 Hz cutoff. The filter has notches at multiples of the cutoff frequency.

The ADC provides for up to 65.535 seconds of sensor warm-up delay before making its first measurement. If the specified warm-up delay is less than 3 sampling periods, the delay before the first reading is taken will be 3 sampling periods. This should be taken into account when computing the warm-up delay.

## **Accuracy**

The ADC will self calibrate to its internal reference whenever the calibrate command is received. The reference, while very stable, is accurate to  $\pm 1\text{mV}$ . This error is measured during factory test and is written into the ADC ROM. A read Vref error command can be used to read this error and use it to obtain 0.0015% error (at 25°C). Another set of coefficients can be read to calibrate readings when the ADC gain is set to 16.



## Example Configurations Using the 8080-0003 Analog I/O Module

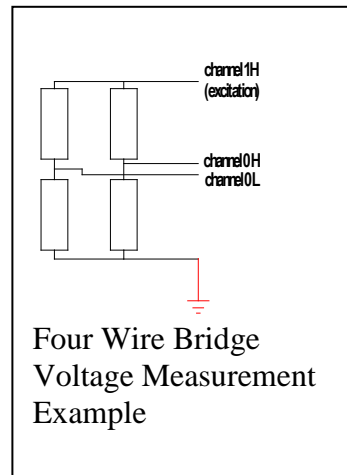
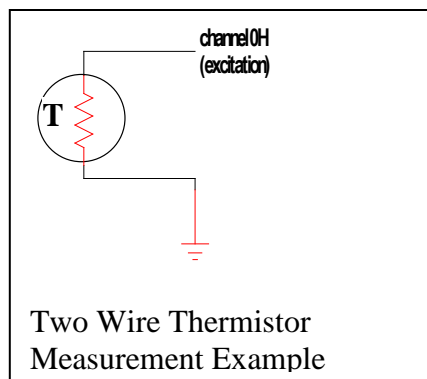
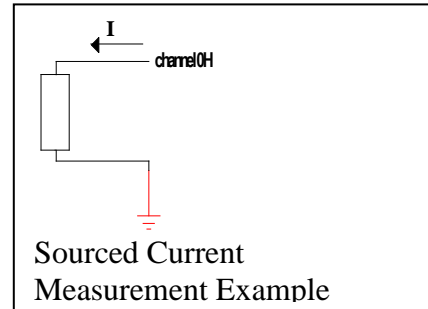
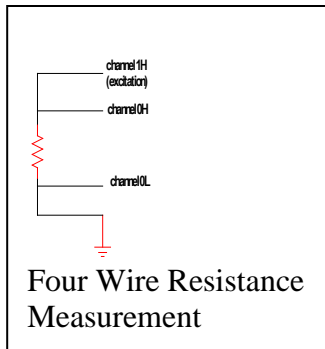
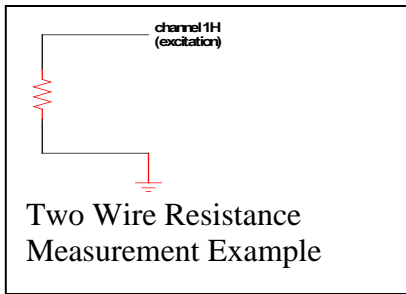
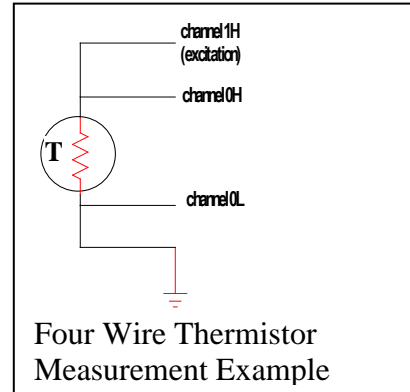
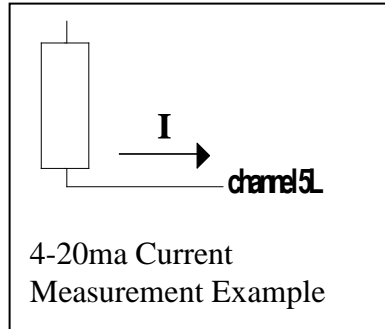
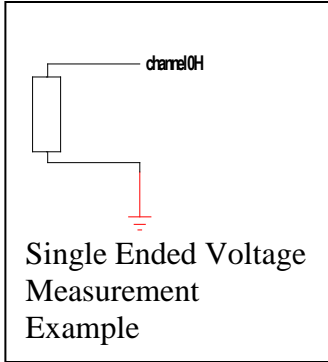

## ADD ON ANALOG I/O MODULE – 8080-0007

---

The 8080-0007 Analog I/O Module (ADC) can be added onto the 9210 to expand its analog input capability. The module has ten analog I/O lines, an excitation voltage, switched battery output, and built in transient protection.

### Features

Ten inputs configurable as 10 single ended channels or 5 differential inputs or a combination of single ended and differential inputs.

16 bit resolution

Input gain settings for increased resolution for low level signals

Single Ended: 0-5 V,  $\pm 78$  mV,  $\pm 19.5$  mV (ADC Block: Voltage, HiGain, x128)

Differential:  $\pm 2.5$ V,  $\pm 78$  mV,  $\pm 19.5$  mV (ADC Block: Voltage, HiGain, x128)

Continuous self-calibration

One switched battery sensor power output

Industrial temperature range operation  $-40$  to  $+60^{\circ}\text{C}$

Multiple sampling rates and digital filtering

Viewing the card from the front, the plug assignments are as follows:

| 1  | 2  | 3 | 4  | 5  | 6 | 7  | 8  | 9 | 10 | 11 | 12 | 13  | 14  | 15 | 16   | 17 | 18    |
|----|----|---|----|----|---|----|----|---|----|----|----|-----|-----|----|------|----|-------|
| 1  | 2  | G | 3  | 4  | G | 5  | 6  | G | 7  | 8  | G  | 9   | 10  | G  | Vref | G  | SwBat |
| 1+ | 1- |   | 3+ | 3- |   | 5+ | 5- |   | 7+ | 7- |    | 9+  | 9-  |    |      |    |       |
| 2- | 2+ |   | 4- | 4+ |   | 6- | 6+ |   | 8- | 8+ |    | 10- | 10+ |    |      |    |       |

G = Ground

SwBat = switched battery out (12V nominal)

Vref = 2.5V excitation voltage –only on when the module is measuring

Differential channel pairs are 1-2, 3-4, 5-6, 7-8, 9-10. The higher voltage line goes to the measured channel.

### Transient Protection Installation Note

The two rear 6-32 mounting screws provide the earth grounding point for the internal spark gap transient protection of the analog inputs. For maximum transient protection a good earth ground needs to be provided to at least one of these screws.

## Specifications

|                   |  |
|-------------------|--|
| Input Range:      | -0.1 to 5V<br>(any input with respect to ground, single ended or differential) |
| A/D Range         |  |
| Single Ended:     | 0-5 V, $\pm 78$ mV, $\pm 19.5$ mV (with respect to ground)                     |
| Differential:     | $\pm 2.5$ V, $\pm 78$ mV, $\pm 19.5$ mV (+ input with respect to – input)      |
| CMRR:             | 120 dB typ   |
| Input Impedance:  | > 10 Gohm typ  |
| Accuracy:         | 0.002% of 5V typ<br>0.003% of 78mV typ HiGain<br>0.03% of 19.5mV typ x128Gain  |
| Temp Coefficient: | 5 ppm/C typ  |
| Ratio Accuracy:   | Limited by A/D resolution (no non-linearities or TC seen).                     |
| Noise floor:      | RMS noise typically < 1bit on 78mV scale and above.                            |
| Excitation:       | 2.5V (up to 50 mA)   |
| SwBat:            | 250 mA   |
| Protection:       | Multistage input protection including spark gaps.                              |

## Example Configurations Using the 8080-0007 Analog I/O Module

Note: All references to Vref and AGND are to the terminals on the module performing the measurement. Do not connect to similarly named terminals on other modules or the 9210.

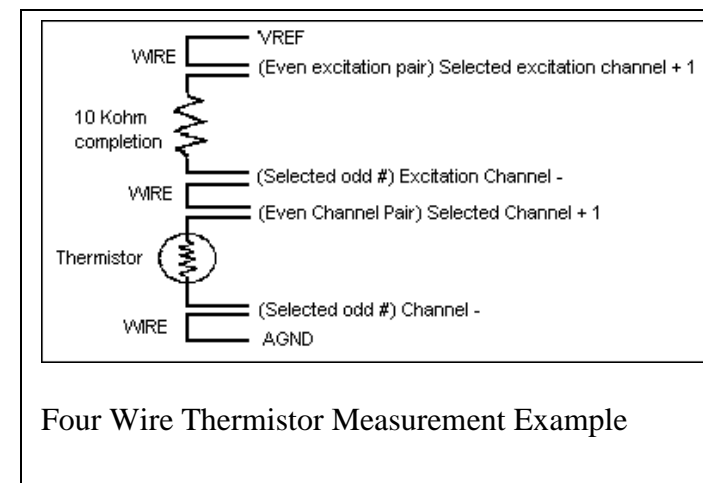
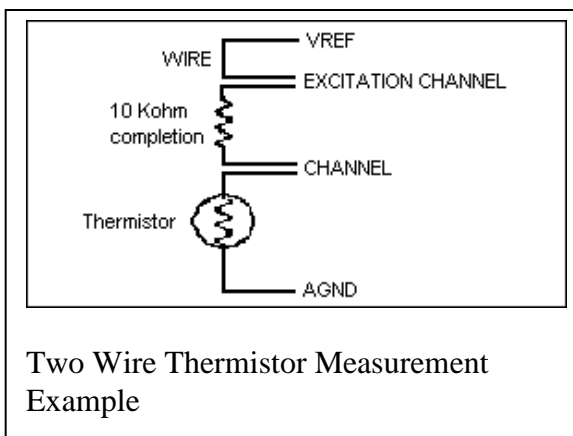
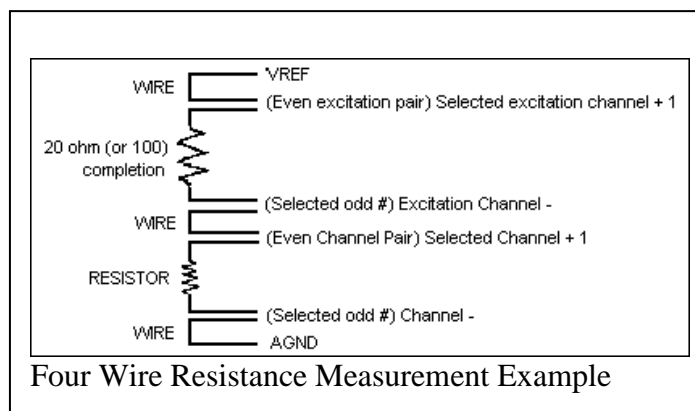
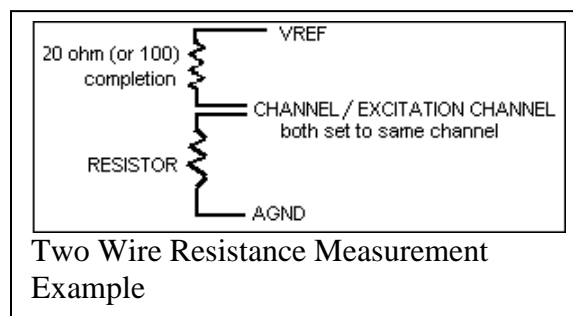
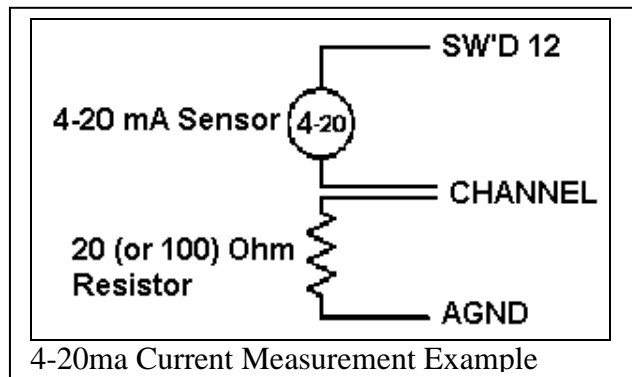
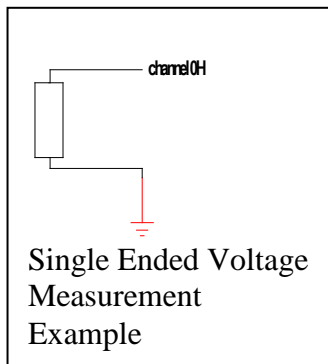

## ADD ON DIGITAL I/O MODULE – 8080-0002

The 8080-0002 Digital I/O Module can be added onto the 9210 to expand its digital I/O capability. The Digital I/O module has eight digital input lines, six of which may be re-programmed as outputs. The two dedicated input lines can be programmed for normal sensitivity for sensing 0 to 5 volt digital signals, or high sensitivity for sensing low level signals such as those from an R.M. Young wind speed sensor.

### Features

Eight digital I/O lines, CMOS level inputs

Six bi-directional, two input only

Reconfigurable I/O

Up to eight counters/frequency inputs with programmable alarm count leading edge, trailing edge or both edges of input pulse.

Up to four quadrature shaft encoder inputs (requires two inputs per sensor) with programmable alarm

Two switchable threshold inputs compatible with R M Young wind sensor.

Switched sensor power

Industrial temperature range operation –40 to +60°C

| Parameter                              | Min | Typ | Max              | Units        |
|--|-----|-----|------------------|--------------|
| <b>Inputs</b>                          |     |     |                  |              |
| Inputs                                 |     |     |                  |              |
| Sampling Interval                      |     | 500 |                  | microseconds |
| Switchable threshold                   | .02 |     | 2.5 <sup>1</sup> | Volts        |
| <b>Output(open drain MOS switches)</b> |     |     |                  |              |
| Pull-up voltage                        | 0   |     | 14               | Volts        |
| Resistance                             | 80  |     | 125              | Ω            |
| Current                                |     |     | 70               | mA           |
| <b>SW BAT output</b>                   |     |     |                  |              |
| Current                                |     |     | 100              | mA           |
| <b>Protection</b>                      |     |     |                  |              |
| Static discharge <sup>2</sup>          |     |     | 2000             | Volts        |
| Lightning, Conducted <sup>3</sup>      |     |     | 400              | Volts        |

<sup>1</sup>CMOS levels.

<sup>2</sup>Human body model.

<sup>3</sup>1 microsecond rise, 1 millisecond fall.

Viewing the card from the front, the plug assignments are as shown below. The I/O lines are numbered 1-8 (LSB is 1).

|   |    |   |   |   |   |   |   |   |    |    |    |    |     |    |     |    |           |
|---|----|---|---|---|---|---|---|---|----|----|----|----|-----|----|-----|----|-----------|
| 1 | 2  | 3 | 4 | 5 | 6 | 7 | 8 | 9 | 10 | 11 | 12 | 13 | 14  | 15 | 16  | 17 | 18        |
| G | 1* | G | 2 | G | 3 | G | 4 | G | 5  | G  | 6  | G  | 7 # | G  | 8*# | G  | SW<br>BAT |

G = Ground

\* = Input Only

# = Switchable sensitivity

## Inputs

When programmed as an input, each line can act as a digitally filtered counter clock or a shaft encoder input. Shaft encoders require two input lines, hence, users can have up to four shaft encoders, eight counters, or a combination of the two. When a run command is received, sampling of the inputs starts.

### Digital filters

The inputs can be low pass filtered before being applied to counters. Shaft encoders are not filtered. The digital filters are up-down counters that count between 0 and a user defined threshold value. Each input line's filter can have a different threshold value. The input to a filter is one of the eight input lines, the output feeds a 32-bit counter. The filter counts up at each sample interval when its input is a one and down when its input is a zero. The counter will not count up if it is at its upper threshold, and it won't count down when its count is zero. The output of the of the filter only changes state when the counter reaches zero or its upper threshold. Thus, if the output state of the filter is a one, it will stay a one until the counter reaches zero. It will then remain zero until the counter counts up to its upper threshold. Valid digital filter time constants are 1 to 255.

### Counters

Up to eight 32-bit counters can be programmed to count on both edges or just the positive-going edge of their respective inputs. Since the input to the counter can be inverted under program control, the counter can also be made to count on the negative going edge by inverting its input. The counter alarm message can be set to be sent after 1 to 255 counts.

### Frequency

The time is logged for each counter every time it counts. This time is reported for each counter when the counters are read. Frequency can be measured by reading the counters twice and computing the difference in time and counts.

## **Shaft encoders**

Up to four quadrature shaft encoders may be set up. The input lines must come from adjacent inputs starting with an odd numbered one (e.g.: 1,2; 3,4; 5,6; 7,8). Each shaft encoder has a 32-bit counter associated with it. It counts up for one direction of rotation and down for the other.

## **Outputs**

Each of the six lines with output capability can be turned on or off under control of the logger. Any output can be pulsed using the pulse output command.

# Appendix D: Specifications



## 9210-0000-2B Xlite

### Main board

|               |   |
|---------------|---|
| Processor     | 32 bit ARM9 core  |
| Memory        | 1 MB boot ROM<br>64MB Flash (32MB for OS and 32MB flash file system for log)<br>32MB SDRAM  |
| Power         | 10 to 16 VDC recommended (20 VDC max)<br>40 ma active (230 mA with display and backlight on)<br><3 ma standby typ.  |
| Clock         | TCXO Real-time clock with battery backup<br>10 seconds/month accuracy -40 to +60C   |
| I/O           | I <sup>2</sup> C bus, 100Kbps, 5 wire, 10ft max<br>SDI-12 Rev 1.3<br>Four RS232 to 115Kbps (3 dedicated, one usable as RS-485)<br>RS485 interface<br>USB Host port<br>SD Host slot  |
| Packaging     | Aluminum case (Drip proof in vertical orientation, IP52)<br>11"x6"x3", weight 3 lbs   |
| Compatibility | Y-Modem<br>SSP  |
| Environmental | -40 to +60C (-60 to +60 C available)  |
| Display       | LCD character Display. 2 line by 20 characters in size.<br>Will display Current Date, Time, and Sensor Values. No setup capability other than the ability to adjust the current sensor value, e.g., set the current stage level of a shaft encoder.<br>Button provided to scroll through Sensor values.<br>-20 to +50 C viewability |

## RS232 Modules

### Speech Modem

A telephone modem expands the system by allowing remote connections to other nodes including a central system. The module includes a modem capable of operation at speeds up to 33.6 kbps. This makes it possible for the remote connection to perform all functions as though the module were local to the system such as retrieve data from the memory module, live data from any module, troubleshoot, diagnose, configure, reconfigure nodes etc. Sutron 8080-0005-1 modem includes V.42 and MNP 2-4 and 10 error correction modes as well as V.42bis and MNP-5 data compression. The modem is UL, CSA, FCC and CTR21 approved.

The Sutron 8080-0005-1 modem has capabilities to support speech. The modem accepts DTMF tones to control the speech and interact with a caller. The user can record custom phrases and words to augment the standard vocabulary using standard PC hardware and software.

## **LOS Radio**

The recorder has a serial port for connecting LOS Radio modems. The port is compatible with third party radio modems such as those manufactured by MDS. Using a radio modem provides one or two way communications between nodes or a central station. The modem makes it possible for the remote connection to perform all functions as though the module were local to the system. Two nodes may use radio communications over a short distance to eliminate expensive wiring. At other times, radio communications will be used between the nodes and a central station. The radio modems must be compatible with repeaters in cases where there is not a clear line-of-sight between two nodes.

## **Satlink Transmitter**

The recorder has a serial port for connecting a Sutron Satlink transmitter. The recorder will set up and operate the satellite radio through the serial port. The setup includes specifying of the transmit mode, ID, time, interval, setting the time, making test transmissions etc. Operations include loading data for transmission, logging transmission status and exceptions, synchronizing clocks etc.

**Appendix E:  
Software  
Development Kit  
(SDK)**

## OVERVIEW

---

The 9210B Software Development Kit (SDK) enables developers to create Sutron Link Libraries (SLLs) that extend 9210B's functionality according to the developer's unique needs. The SDK is most often used to create libraries containing custom *setup blocks*, *property pages (tabs on the main screen)*, and *Setup entries* (branches in the Setup tab tree), but may also be used to create libraries that manipulate ports, files, peripherals, and any other entity accessible through standard Windows CE operating system API calls.

The SDK may be downloaded from Sutron's website at:

<http://www.sutron.com/downloads/XpertSDK.htm>.

The SDK is intended for use with Microsoft eMbedded Visual C++ 4.0 (eVC) which, at the time of this writing, is available at no charge from Microsoft. This toolset contains the compiler, linker, and operating system libraries necessary to develop for the 9210B platform. It may be ordered on CD from Microsoft (in which case a modest shipping charge applies), or downloaded from:

<http://www.microsoft.com/downloads/details.aspx?FamilyID=1dacdb3d-50d1-41b2-a107-fa75ae960856&displaylang=en>

Sutron assumes that any developer using the tools is already knowledgeable concerning C++ and basic Windows programming.

Please note that custom SLLs must be rebuilt (compiled and linked using eVC 4.0) whenever you upgrade to a new version of 9210B firmware. This must be done with the version of the SDK that matches the version of 9210B firmware.

# **Appendix F: Creating Custom Voice Files**

## OVERVIEW

---

9210 speech files are binary data files containing audio data in Rockwell 4-bit ADPCM 7200hz mono format. These files are "headerless", meaning they have no information describing the content of the file, just sample data. Users can create these files using one of several aftermarket programs for the PC. One such program is "Vox Studio" by Xentec. This program allows the user to record speech using a microphone connected to the PC, and save it in the appropriate format (Rockwell 4-bit ADPCM 7200hz mono). The file can then be loaded into the 9210 using Xterm (into the corresponding language subdirectory under \flash disk\speech\, e.g., English, Spanish, etc.), and used by selecting it in a ComsTag dialog, just as you would any other speech file. (Note: You will need to save the file with a unique name and with the extension ".vox" so that the 9210 will display the file for selection).

The program "Vox Studio", by Xentec, is available for download at: <http://www.xentec.be/download/download.html>. Note: the unregistered version of this program limits the length of files to 5 seconds. As of this writing, a fee of \$399 is required to register, which removes the limitation.

When using Vox Studio or any other editing program, Sutron recommends trimming off the leading and trailing silence to help reduce the size of the file. We also recommend using the normalize function to adjust the volume of the recorded phrase.

# **Appendix G: Autoexec.bat and Remote.exe**

## OVERVIEW

---

Starting with version 2.0.0.0 and greater, the autoexec.bat file is AUTOMATICALLY updated by the system when changes to the COMS are made. The only time a user needs to modify the autoexec.bat file manually is if the autoexec.bat file is corrupted or missing.

### Autoexec.bat

The 9210 executes instructions in the \flash disk\autoexec.bat file on startup. If the file doesn't exist, or if the user bypasses execution, the system will run \windows\remote.exe com1:115200. This remote.exe program is the program that allows communication with XTerm. With remote.exe running, you will be able to update the software, setups and monitor the system as needed.

To skip the autoexec.bat , connect a PC running a terminal program to COM1 and apply power to the unit. After the terminal displays "Flushing caches", press CTRL key and C <CTRL-C>, hold until message displays "Bypassing \flash disk\Autoexec.bat..."

The factory default for autoexec.bat is as follows:

```
\Flash Disk\remote.exe com1:115200
\Flash Disk\Xpert.exe
```

The first line runs remote.exe, enabling communications on com1. The second line runs the main application program. The details of running remote.exe are explained in the following section. xpert.exe accepts several command line options:

```
/Debug      send debug messages to the serial port
/SDI COM4:  use COM4 (RS-485) for SDI-12
```

**NOTE:** If redirecting SDI to a different com port, the com port settings in the coms section of setup should be left as none. Coms is strictly for configuring remote and ssp devices.

You may make changes to the autoexec.bat by editing the file on your PC and then transferring it to the 9210. However, if you make a mistake and render it inoperable, you will need to follow the instructions to skip autoexec.bat on startup so you can transfer a correct autoexec.bat to the 9210.

### Remote.exe

The system has a remote.exe in the \windows directory. However, it is possible to load an updated version into \flash disk and run it instead of the version in \windows. Remote can support different communications devices on each of its serial ports. All the ports are specified by the command line arguments when remote.exe is run.

Remote supports the following communications devices:

| Name | Device                    | H/W Flow | Description  |
|------|---------------------------|----------|--|
| COMx | Direct connection to a PC | RTS/CTS  | The Xpert is connected to a PC using a RS232 cable. Typically the PC will run XTerm, PCBASE2 or XCONNECT. Both a command |



|                        |                               |          |  |
|------------------------|-------------------------------|----------|--|
|                        |                               |          | prompt and SSP are available.  |
| MOD<br>EM <sub>x</sub> | Commercial<br>modem.          | RTS/CTS  | The 9210 is connected to a Hayes compatible telephone modem. No voice functions will be supported.   |
| RADI<br>O <sub>x</sub> | LOS Radio<br>modem.           | None     | The 9210 is connected to a LOS radio modem. The 9210 can communicate with other stations and master stations on the radio network using SSP.                     |
| VOIC<br>E <sub>x</sub> | Sutron<br>Voice/Modem.        | RTS/CTS  | The 9210 is connected to Sutron's Voice Modem. Both Voice and Data functions will be supported.  |
| SSP <sub>x</sub>       | SSP only direct<br>connection | None (*) | The 9210 is connected to a 9210, a Base Station PC, or another RTU that supports SSP using an RS232 cable. Typically the PC will run XTerm, PCBASE2 or XCONNECT. |
| RS <sub>x</sub>        | RS-485 connection             | None     | The 9210 is directly connected to another 9210 using SSP.  |

Where x is the COM port number 1 to 4

(\*) H/W Flow control was enabled on SSP ports before version 2.3, and may be re-enabled if needed with the /HS option.

Remote also supports the following command line arguments:

| Option              | Description  |
|---------------------|--|
| /F UnitID           | ID to respond to when receiving an SSP message (note this can be omitted if the user has set the station name.)  |
| /T MasterID         | ID to use in SSP message when sending an alarm   |
| /HS <sub>x</sub> +  | Force hardware RTS/CTS handshaking on, on port x. Use this to enable handshaking on a device mode which normally has it disabled (ie. RADIO or SSP).   |
| /HS <sub>x</sub> -  | Force hardware RTS/CTS handshaking off, on port x. Use this to disable handshaking on a device mode which normally has it enabled (ie. COM, MODEM, VOICE).   |
| /DTR <sub>x</sub> + | Force DTR to be enabled all the time on port x when used in conjunction with a port in SSP: or COM: modes. In SSP: mode DTR is asserted whenever data is transmitted, and in COM: mode DTR is asserted whenever a connection is made. This switch has no effect on RADIO: mode where DTR is used to key the transmitter, or MODEM: or VOICE: mode where DTR is used to hangup the phone. |
| /DTR <sub>x</sub> - | Force DTR to be disabled all the time on port x, when used in conjunction  |

|            |  |
|------------|--|
|            | with a port in SSP: or COM: modes.   |
| /AUTOLOGON | Causes command prompt sessions to automatically login as the user name "AUTO" with no password. This can be used to limit access to the system, or to allow a custom command parser full control of the session. |
| /DEBUG     | Disables resetting of unit by the software watchdog so it doesn't interfere with debugging code.   |
| /NOCOM1    | Causes a session on COM1: not to be started so COM1: may be used for some other purpose.   |

Example: the following command runs remote.exe to support a direct connection on COM1 and a Sutron voice modem on COM3:

```
\flash disk\remote.exe com1:115200 voice3:115200
```

It's usually not possible to place special command line options for Remote in the Autoexec.bat file because whenever a com port setting is changed in the Xpert application, the settings you make will be replaced. For this purpose extra command line options may be placed in a file called "Remote.opt". This is a simple ASCII text file that can be created with notepad and transferred to the 9210 and placed in the \Flash Disk folder. It can contain a single line of options that are concatenated to the parameters passed to Remote in the Autoexec.bat. So for instance, if you wished to enable AUTOLOGON and disable H/W handshake on port 2, you would place the following in the Remote.opt file:

```
/AUTOLOGON /HS2-
```

Bypassing Autoexec.bat by pressing Ctrl-C will also bypass any options in the Remote.opt file as of version 3.2.

Remote.exe is designed to communicate with Sutron's XTerm program to provide a wide range of functions. In addition, you can use a terminal emulator with remote and issue one of the following commands. Note: if you have set up any usernames and passwords in the 9210, you will be prompted to enter a username and password in order to issue commands to remote.exe

Table of remote commands:

|                  |   |
|------------------|---|
| ABOUT            | Shows the same information as the 9210's Status tab, About button   |
| CAL sensor value | Calibrate "sensor" using "value". Where sensor is the name of the block and must be a unique name (see <a href="#">rename</a> for details).<br><br>For example, to calibrate a sensor block named "stage" to value 15.5:<br><br>e.x. cal stage 15.5 |
| CD path          | Change directory  |
| CAL sensor value | Calibrate "sensor" using "value". For example, to calibrate a sensor block named "stage" to value 15.5:   |

|   |  |
|---|--|
|   | e.x. cal stage 15.5  |
| COPY src dest   | Copy a file. A wildcard * character may be used as part of the src to match one or more files, but then dest should contain the name of a folder. If a path contains spaces it must be surrounded in double quotes.<br>ex: copy “\usb card\*.*” “\flash disk\”   |
| DATE [mm-dd-yyyy]   | Displays or sets the date  |
| DEFAULT   | Exits and runs \Windows\Remote COM1:115200   |
| DEL file  | Delete file  |
| DIR path  | Display directory  |
| GET [sensor-list] [/F logfile]<br>[/S mm-dd-yyyy hh:mm:ss]<br>[/E mm-dd-yyyy hh:mm:ss] [/CSV]<br>[/YMODEM] [/ZIP] [/C]<br>[/REVERSE] [/BAD]<br>[/INVERT] [/OLDEST]<br>[/NEWEST] [/TODAY]<br>[/YESTERDAY]<br>[/WEEK] [/MONTH]<br>[/YEAR] [/HOUR] | Shows archived log data. Specifying a sensor-list will cause only those sensors to be displayed.<br><br>/F specifies a logfile, SSP.LOG is used by default.<br><br>/S specifies a start date and time for retrieval. If a start date is not specified then it will default to where the last GET left off.<br><br>/E specifies an end date and time for retrieval. If an end date is not specified the end of the log is assumed.<br><br>/CSV will use a comma-separated format. /CSV will also show more decimal places (by default only 3 places are shown to help keep columns aligned).<br><br>/YMODEM will cause the report to be transferred as <sitename>_YYYYMMDD.TXT, where <sitename> is the name of the station, and YYYYMMDD is the date of the first entry in the log. If the data is from a log other than SSP.log then the format of the file created will be as follows:<br><sitename>_<logfile>_YYYYMMDD.TXT.<br><br>/ZIP will cause the output to be compressed in to a .ZIP archive file with a .ZIP extension.<br><br>If there are more than 24 lines of output, the display will pause with a “– More – ” prompt until space is pressed to continue, or ESC to abort<br><br>/C will cause the output to be continuous (without pause) until the end is reached or ESC is pressed.<br><br>/REVERSE will cause the output to be generated in reverse time order (newest to oldest).<br><br>/BAD will cause only bad data, and system errors to be displayed.<br><br>/INVERT will display all sensors that are not contained in the sensor-list. |

|   |  |
|---|--|
|   | <p>/OLDEST will start the dump with the oldest data in the log.</p> <p>/NEWEST will start the dump with the newest data in the log, especially useful when combined with /REVERSE.</p> <p>/TODAY will start the dump with today.</p> <p>/YESTERDAY will start the dump with yesterday.</p> <p>/WEEK will start the dump with the last Sunday.</p> <p>/MONTH will start the dump with the 1st of the current month.</p> <p>/YEAR will start the dump at Jan 1 of the current year.</p> <p>/HOUR will start the dump at the top of the current hour.</p> |
| HELP  | Displays the list of commands.   |
| INFO  | Shows the same information as the 9210's Status Tab  |
| IPCONFIG [/ALL]   | Displays the ethernet configuration information that has been assigned by a connected router via the DHCP protocol including the IP address assigned to the 9210. The /ALL option includes more detailed information including the physical address (i.e. MAC ID) and DHCP lease times.  |
| LANOFF  | Turns OFF the Ethernet (Local Area Network) interface  |
| LANON   | Turns ON the Ethernet (Local Area Network) interface. DHCP is used to locate the gateway, retrieve the IP address and other internet settings. Use the IpConfig command to view the current settings.<br><br>Also related: Release, Renew.   |
| LOGOUT  | Logout (also quit or exit)   |
| MAIL [port to msg]  | Reads or sends mail message  |
| MD dir  | Make a directory   |
| MEASURE [...]   | Measure works exactly the same as the SHOW command except it causes a live-reading of the sensor values to be taken before the results are displayed.  |
| MEM   | Display memory usage   |
| PASSTHRU<br>port:parity,bits,stop<br>[/HW] [/ECHO]<br>[/BREAK] [/CONTROL] | Opens the specified port (either unopened or under the control of remote), where port can be COM2 or VOICE3 or SSP2 depending on how the port is configured. For generic serial ports, use COM and the port number. If the port is in use by other all ports (GPRS, iridium, etc), the port must first be disabled, then re-enabled when finished. Any characters typed are sent to the port. Any characters received are displayed. Terminate with by pressing ESC three times in a row.  |

|                    |  |
|--------------------|--|
|                    | <ul style="list-style-type: none"> <li>• The /HW option enables RTS/CTS h/w handshaking.</li> <li>• The /ECHO option causes the characters you type to be echoed back which can be useful when communicating with half-duplex devices.</li> <li>• The /BREAK option will send a 500ms break to the serial port after connecting. This may be used to wakeup sensors which require a break.</li> <li>• The /CONTROL option (added in version 3.4) allows the DTR control line to be passed through. This used to be the default behavior, but as of 3.4 dropping DTR or disconnecting will cause a logout to occur.</li> </ul> <p>The normal user inactivity timeout will be applied to passthru sessions.</p> <p>Note: If using passthru to access a port already under control of Remote, then the existing port settings are always used. This includes hardware handshaking. If you try to communicate with a port with hardware handshaking enabled, and CTS is low preventing transmission, then the message [CTS LOW] is displayed.</p> <p>Pressing ESC twice, followed by a ? will show the status of the control lines (H high, L Low), pressing ? again any number of times will update the current status of those lines, pressing any other key will stop checking the status of the lines and return to passthru mode.</p> |
| RD dir             | Remove a directory   |
| REBOOT             | Reboots the 9210   |
| RECORDING [on off] | The RECORDING command will display the current recording status. If “on” is specified then recording is turned on, likewise “off” will turn recording off.   |
| RELEASE [adapter]  | Releases DHCP leases on network adapters or the specific adapter if specified. The adapter index can be retrieved and the current lease viewed with the “IPCONFIG /ALL” command. DHCP leases are usually managed automatically, but this command can be used to verify that a connected router is assigning IP addresses reliably.   |
| REN old new        | Rename a file  |
| RENEW [adapter]    | Renews DHCP leases on network adapters or the specific adapter if specified. The adapter index can be retrieved and the current lease viewed with the “IPCONFIG /ALL” command. DHCP leases are usually managed automatically, but this command can be used to verify that a connected router is assigning IP addresses   |

|   |  |
|---|--|
|   | reliably..   |
| REPORT mode   | Set status reporting to on, off, none, ssp[0-9], low, medium, high, i2c, all, debug. (more below)  |
| SET sensor[:value] data   | Sets the current value of a tag to the specified data. For tags with multiple possible values, the value number may be specified (1-n). Data may be an integer, a floating point number, or a double-quoted string.  |
| SHOW [sensor-list]<br>[/SENSOR/TAG]<br>[/CSV] [/YMODEM]<br>[/C] | <p>The SHOW command by itself will display the current value for every sensor and tag, that does not have a “U” quality, in the system in a tabular report. Sensors are the input blocks in the system. Tags include any intermediate or final value in the setup marked with a ComsTag, a custom tag created with Basic, or a Field Variable.</p> <p>Specifying a sensor-list will cause only those sensors and tags to be displayed (sensors and tags can have the same name).</p> <p>/SENSOR shows only sensors.</p> <p>/TAG shows only tags.</p> <p>/CSV will use a comma-separated and quoted format that can be imported in to a spreadsheet. /CSV will also show more decimal places (by default only 3 places are shown to help keep columns aligned).</p> <p>/YMODEM will cause the report to be transferred using the Ymodem protocol as &lt;sitename&gt;_show.TXT, where &lt;sitename&gt; is the name of the station.</p> <p>If there are more than 24 lines of output, the display will pause with a “- More -” prompt until enter is pressed to continue, or ESC to abort. The [/C] option will cause the output to be continuous (without pause) until the end is reached or ESC is pressed.</p> <p>The alarm status of each tag is displayed. More than one alarm condition may be displayed. The following codes are common:</p> <p>OK - not in alarm<br/>A - in alert (transmitting)<br/>H - high limit exceeded<br/>L - low limit exceeded<br/>D - rate of change exceeded</p> |
| SHUTDOWN  | Causes the 9210 app to exit so that Xpert.exe, DLLs, and SLLs may be upgraded.   |
| SMS [cmd]   | The SMS command allows commands normally issued via SMS text message to be issued at the command line. If cmd is omitted, the current state of the GPRS modem is displayed, example:   |

|                        |   |
|------------------------|---|
|                        | <p>\Flash Disk&gt;<b>SMS</b></p> <p>GPR2: Standby-On next task SelfTimed at 17:30:05<br/> NextST:17:30:05 LastAlarm:16:39:15 LastST:17:15:05</p> <p>SMS2: Standby</p> <p>Otherwise cmd is processed as follows:</p> <p><b>STAP</b> [url[:port]] Perform a "shoulder tap" by opening a GPRS connection to either the default command server or the specified url and port</p> <p><b>REDIR</b> [url[:port]] Open a GPRS connection to the default redirector server or the specified url and port</p> <p><b>SETPIP</b> [url] Set the PrimaryIP for GPRS connections</p> <p><b>SETSIP</b> [url] Set the SecondaryIP for GPRS connections</p> <p><b>SETMP</b> [port] Set or show the TCP port to be used for GPRS messages</p> <p><b>SETCP</b> [port] Set or show the default TCP port to be used for GPRS command sessions</p> <p><b>SETRP</b> [port] Set or show the default TCP port to be used for GPRS Redirector sessions</p> <p><b>HELP</b> Displays this list</p> |
| <b>STATION</b> [name]  | The STATION command will display station's name. If a name is passed to the command, then the station name will be set and the change will take effect immediately.   |
| <b>STATUS</b> [clear]  | Display and or clear com port status  |
| <b>STOP</b> name       | Stops a process forcibly  |
| <b>TASKS</b>           | Displays tasks and heap usage   |
| <b>TIME</b> [hh:mm:ss] | Displays or sets the time   |
| <b>TYPE</b> file [/C]  | <p>Display a file to the screen. If the file is longer than 24 lines the display will pause with a "– More –" prompt until enter is pressed to continue, or anything else to abort.</p> <p>The [/C] option will cause the output to be continuous (without pause) until the end is reached or ESC is pressed.</p>   |
| <b>OLDUPGRADE</b>      | <p>When running \Windows\Remote.exe this command exits and upgrades to a new version of Remote downloaded to the \Flash Disk folder.</p> <p>When running \Flash Disk\Remote.exe this command exits and</p>  |



|                           |  |
|---------------------------|--|
|                           | downgrades to the original version in \Windows. In either case, command line settings are retained.  |
| UPGRADE [/YES] [/P]       | <p>The UPGRADE command is used to upgrade system files using the Ymodem protocol. This previous version of this command is now called “OLDUPGRADE”. An “upgrade” can consist of a single new file to add to the system, or complete set of application files contained in a .ZIP file. The upgrade command cannot upgrade the kernel or the loader, only application files such as Xpert.exe, Remote.exe, DLLs, SLLs, .BAS files, etc are supported. The .UPG file used to perform upgrades with XTerm is not used. The user is prompted “Are you sure? ” and must respond with a “Y” or “y” before the upgrade proceeds. Following are the steps performed:</p> <p>The Xpert application is shutdown.</p> <p>Any old application files on the \Flash Disk are deleted. This includes XPert.exe, *.DLL, and *.SLL.</p> <p>The file transfer is performed.</p> <p>The file or file(s) are then stored on the \Flash Disk.</p> <p>If the currently executing Remote.exe needs to be replaced, then Remote will shut itself down and restart the new version. This will drop the current connection.</p> <p>The Autoexec.bat file will be verified and/or modified to make sure that the correct version of Xpert.exe is executing (\Flash Disk\Xpert.exe if it exists, otherwise \Windows\Xpert.exe)</p> <p>The Xpert application is re-started (the one stored in the \Flash Disk folder if it exists, otherwise the one in the \Windows folder).</p> <p>Options:</p> <p>The /YES option will bypass the “Are you sure? ” prompt.</p> <p>The /P option enables a partial upgrade for situations where just some of the files are being changed. Step 2 (the deletion of files) is skipped. This option can be used to download a new version of Remote, or to add some new .SLL files, or .BAS files.</p> |
| VER                       | Displays the build date Remote was created   |
| YMODEM [file-list] [/ZIP] | <p>With no options specified, the YMODEM command will receive files using the Ymodem protocol and store them on the 9210. If the file being transferred has a .ZIP extension, then it will be automatically expanded and the contents stored in the current folder (typically \Flash Disk).</p> <p>The command may be used to send files using the Ymodem</p>  |



|  |  |
|--|--|
|  | <p>protocol by supplying a file name or a file-list. A file-list is simply a list of files to send (delimited by spaces; use quotes around files containing spaces).</p> <p>/ZIP may be used when sending files to cause the files to be compressed in to a .ZIP archive before being transferred. The name of the archive will be the same as the first file in the list with a .ZIP extension.</p> <p>A transfer can be aborted by pressing ESC 3 times.</p> |
|--|--|

The command prompt supports a 10-line command recall capability invoked by pressing UP ARROW to scroll back through old commands, or DOWN ARROW to scroll to newer commands.

Most all commands support the /YMODEM, /ZIP, and /C options. Unless stated otherwise the default filename for the output of a command will be station\_command.txt for a /YMODEM transfer or station\_command.zip for a /ZIP transfer.

When a command displays more than 24 lines of output, the “– More –” prompt will be displayed. The user may press space to display another 24 lines, enter to display the next line, or C to start displaying lines continuously without break. The “more” mode of output may be re-enabled at any time by pressing M. Output may be terminated by pressing ESC.

The REPORT command defines message filters in Remote and the Xpert app. Reporting requires extra processing that will slow operation of the unit. The options can be combined. For example to monitor COM2 for SSP messages, watch I2C messages, and observe debug messages, try the command:

```
\Flash Disk> report SSP2 I2C Debug
Reporting enabled and filter is set
```

Here’s a summary of what types of messages each option will display:

|             |  |
|-------------|--|
| None or Off | No messages  |
| SSP         | SSP messages from any communication port, and error, warning, and status messages. SSP messages are decoded. SSP messages over TCP/IP are not displayed.                     |
| SSPn        | SSP messages from the specified communication port, i.e. SSP4 would show messages to/from COM4.. If SSP0 is specified then SSP messages transported by TCP/IP are displayed. |
| Low         | Error messages   |
| Medium      | Error and warning messages.  |
| High        | Error, warning, and status messages.   |
| All or On   | Debug, error, warning, status and SSP messages from serial ports 1 through 9.  |

|       |   |
|-------|---|
| Debug | Debug, error, warning, and status messages. |
| I2C   | Decoded I2C messages                        |

The SSP Decoder displays the time of a message, the source and destination, the sequence number, the operation code, the size of the message, and partial decoding of the contents of the message.

```

SSP Decoder Example:
\Flash Disk> report SSP2
17:16:38 COM2: RTU>XCONNECT 4865191 TimeTag,16,09/18/2006
17:14:00,String,BAT,Real,12.529999 | TimeTag,20,09/18/2006
17:14:00,String,AirTemp,Real,72.799988 | TimeTagEnd,0
17:16:39 COM2: XCONNECT>RTU 11720692 Ack,1,TimeTagEnd
17:16:39 COM2: XCONNECT>RTU 11720942 SetClock,6,09/19/2006 17:16:42
17:16:45 COM2: XCONNECT>RTU 11721942 CurdataReq,0
17:16:45 COM2: RTU>XCONNECT 4871422
Curdata,30,BAT,2,0,Nil,1,Alarm,OK

```

### ABOUT Command Example

```

\Flash Disk> ABOUT
File                               Version
=====
Xpert                              3.2.0.4
Kernel                             5.1.8
Monitor                            5.1.8, Mon 09/15/2008 14:02:13.60
Loader                             5.1.8
Remote                             3.2.0.4
\Xpert.exe                         3.2.0.4
\Windows\Engine.dll                3.2.0.4
\Windows\Logger.dll                3.2.0.4
\Windows\LogMgr.dll                3.2.0.4
\Windows\LZO.dll                   3.2.0.4
\Windows\SDI.dll                   3.2.0.4
\Windows\Utils.dll                 3.2.0.4
\Windows\Deflib.sll                3.2.0.4

```

### Get Command Example

The Get command shows the data logged, picking up where the last Get left off (or end of log, if the first time run).

```

\Flash Disk> GET
[SSP.LOG]
10-26-2005 13:45:00 STAGE           1.20  G ft
10-26-2005 13:45:00 AIRTEMP        78.20 G F
10-26-2005 14:00:00 STAGE           1.21  G ft
10-26-2005 14:00:00 AIRTEMP        78.25 G F
10-26-2005 14:15:00 STAGE           1.22  G ft
10-26-2005 14:15:00 AIRTEMP        79.10 G F
10-26-2005 14:30:00 STAGE           1.20  G ft

```

```

10-26-2005 14:30:00 AIRTEMP      79.00  G F
10-26-2005 14:45:00 STAGE        1.20  G ft
10-26-2005 14:45:00 AIRTEMP      78.60  G F

```

The following shows the most recent data followed by older data:

```

\Flash Disk> GET /NEWEST /REVERSE
[SSP.LOG]
10-26-2005 14:45:00 AIRTEMP      78.60  G F
10-26-2005 14:45:00 STAGE        1.20  G ft
10-26-2005 14:30:00 AIRTEMP      79.00  G F
10-26-2005 14:30:00 STAGE        1.20  G ft
10-26-2005 14:15:00 AIRTEMP      79.10  G F
10-26-2005 14:15:00 STAGE        1.22  G ft
10-26-2005 14:00:00 AIRTEMP      78.25  G F
10-26-2005 14:00:00 STAGE        1.21  G ft
10-26-2005 13:45:00 AIRTEMP      78.20  G F
10-26-2005 13:45:00 STAGE        1.20  G ft

```

The following shows all bad stage data that occurred today:

```

\Flash Disk> GET STAGE /BAD /TODAY
[SSP.LOG]
10-26-2005 05:45:00 STAGE        1.01  B ft
10-26-2005 05:45:00 STAGE        1.24  B ft

```

The following shows all entries in the system log for the current week:

```

\Flash Disk> GET /F SYSTEM /WEEK
[SYSTEM.LOG]
10-23-2005 01:05:05 NOTE (Stat) - User Bob logged in.
10-23-2005 01:06:50 NOTE (Stat) - Loaded \Flash Disk\543.ssf setup
file.
10-23-2005 01:05:05 NOTE (Stat) - Running.

```

The following sends the last month of AIRTEMP and STAGE data via Ymodem to the PC in CSV format:

```

\Flash Disk> GET AIRTEMP,STAGE /F SSP /MONTH /CSV /YMODEM
Ready to send YModem file(s) (press ESC to abort)

```

Ymodem all non-STAGE data from August. ZIP it first to reduce the amount of data that needs to be transferred.

```

\Flash Disk> GET STAGE /INVERT /S 08-01-2005 /E 08-31-2005 /ZIP
Ready to send YModem file(s) (press ESC to abort)

```

### INFO command Example

```

\Flash Disk> INFO
Recent Status:
  10/26 13:42 (Stat) - Remote user Bob logged in.
  10/26 13:42 (Stat) - Remote user Bob logged out. Active for 104
sec.
Com Status: Stopped
Memory Load 51 percent

```

```

Total Physical 7725056
Available Physical 3833856
Total Virtual 33554432
Available Virtual 29163520
Number of resets: 110
I2C STATISTICS:
#Rx:22 #Error:0 #Fail:0
#Tx:31 #Error:0 #Fail:0
NAK:0 TIMEOUT:0
COLLISN:0 OVRFLOW:0
BUSERR:0 RXERROR:0
SLAVETX:0 CHKSUM:0
STOP:0 BUSBUSY:0
RESTART:0 BADCHAN:0
Network Configuration
  DNS Servers . . . . . : 192.168. 168.1
  Ethernet adapter. . . : CS8900A1
  IP Address. . . . . : 192.168. 168.10
  Subnet Mask . . . . . : 255.255.255.0
  Default Gateway . . . : 192.168.168.1

```

### MAIL Command Example

```

\Flash Disk> MAIL
Mailbox for COM2:
10/26/2005 16:23:53 Mail from: BASE, Remember to cal the 4-20 input!
10/26/2005 16:23:18 Mail from: BASE, This is a test mail message.
\Flash Disk> MAIL 2 BASE All taken care of, I'm leaving the site
now.
Mail delivered.

```

### MEASURE/SHOW Command Example

The following measures all sensors and tags:

```

\Flash Disk> MEASURE
SENSOR
  BATVAL (Battery)          12.781 G V
  BATVAL (Temp)            28.767 G C
  STAGE                     1.23 G ft
  AIRTEMP (Temp)           78.32 G F
  AIRTEMP (Humid)          25.32 G %
TAG
  STAGE                     1.23 G H A
  AIRTEMP                   78.32 G OK

```

Show just the AIRTEMP tag

```

\Flash Disk> SHOW AIRTEMP /TAG
AIRTEMP                    78.32 G OK

```

Zip up the results of a show and transfer it to the PC using Ymodem.

```

\Flash Disk> SHOW /ZIP
Ready to send YModem file(s) (press ESC to abort)

```

Show all the sensor values in comma-separated format

```
\Flash Disk> SHOW /CSV /SENSOR  
BATVAL (Battery), 12.7813835841049,G,V  
BATVAL (Temp), 28.7679583945093,G,C  
STAGE, 1.23,G,ft  
AIRTEMP (Temp), 78.3253939059343,G,F  
AIRTEMP (Humid), 25.3246839763986,G,%
```

### PASSTHRU Command Example

```
\Flash Disk> PASSTHRU COM3:2400,N,8,1  
Passthru operation has begun (press ESC ESC ESC to abort)  
AT  
OK
```

### RECORDING Command Example

```
\Flash Disk> RECORDING OFF  
Stopping.  
Recording is OFF  
\Flash Disk> RECORDING ON  
Running.  
Recording is ON
```

### SET Command Example

The following turns a pump called PUMPON on (set it to 1):

```
\Flash Disk> SET PUMPON 1  
\Flash Disk> SHOW PUMPON /TAG  
PUMPON 1 G OK
```

Turn a pump called PUMPON off (set it to 0)

```
\Flash Disk> SET PUMPON 0  
\Flash Disk> SHOW PUMPON /TAG  
PUMPON 0 G OK
```

### SHUTDOWN Command Example

```
\Flash Disk> SHUTDOWN  
Stopping.  
The Xpert application has been shutdown.
```

### STARTUP Command Example

```
\Flash Disk> STARTUP  
Xpert has been started.
```

### STATION Command Example

```
\Flash Disk> STATION site123  
The station is named site123
```

## STATUS Command Example

```
\Flash Disk> STATUS
COM1:115200,3.0,3,10.0,1.0    - bob(1) is logged in | Cmd: \Flash Disk>status
  SSP STATS: RX: 959, TOTAL: 959, BAD: 0    TX: 574, BAD: 0, FAIL: 0
RADIO2:9600,10.0,3,30.0,0.1  - Unknown (0) is logged out | Cmd:
  SSP STATS: RX: 2027, TOTAL: 2027, BAD: 0    TX: 1996, BAD: 0, FAIL: 0
VOICE3:115200,3.0,3,10.0,1.0  - Unknown(0) is logged out | Cmd:
```

## UPGRADE Command Example

```
\Flash Disk> UPGRADE
Are you sure? Yes
Stopping.
The Xpert application has been shutdown.
Ready to receive YModem file(s) (press ESC to abort)
(ymodem send the new file or files in a .zip archive)
Upgrade complete: Restarting Xpert.
```

## YMODEM Command Example

The following sends a file from your PC and place it on the Xpert using the Ymodem protocol:

```
\Flash Disk> YMODEM
Ready to receive YModem file(s) (press ESC to abort)
```

The following gets the files PUMP.BAS and FLUME.BAS from the 9210 and transfer them to your PC using the Ymodem protocol:

```
\Flash Disk> YMODEM PUMP.BAS FLUME.BAS
Ready to send YModem file(s) (press ESC to abort)
```

Get all setup files from the station, ZIP them up, and transfer them to your PC using the Ymodem protocol

```
\Flash Disk> YMODEM *.SSF /ZIP
Ready to send YModem file(s) (press ESC to abort)
```

# APPENDIX H: SATLINK TX FORMATS

Satlink transmissions can be configured to transmit the data in several different formats:

1) “SHEF” format conforms to NESDIS Standard Decimal format specifications. The format is ASCII and readable by persons without the aid of a computer. Sensor data has a label, a time offset (how many minutes old the data is), the interval of the data and then a variable number of data items (recent data first (to left)).

**EXAMPLE:**

:HG 0 #15 10.20 10.15 :PC 0 #15 50 49 :TA 0 #15 -22.1 -22.0 -23.5 -23.0

2) “SHEF Fixed” is a special version of the SHEF format where numbers are fixed to seven character . Sensor data has a label, a time offset (how many minutes old the data is), the interval of the data and then a variable number of data items (recent data first (to left)).

**EXAMPLE:**

:HG 0 #15 -12345. 12345.1 :PC 0 #15 12345.1 1234.11

3) “Bin Int” is a binary interleaved format, identical to the 8210 binary transmission format. The data are in the 6-bit pseudo binary format required by NESDIS.

**EXAMPLE:**

2@@Gt@Gs@Sx@Sr@@i@@i

4) “Bin NonInt” is a binary non-interleaved format. This format also uses the 6-bit pseudo binary format but allows different amounts of data to be sent for each sensor. The data is not interleaved, i.e., one sensor’s data set appears together in the transmission.

EXAMPLE:

2@@Gt@Gs@Sx@Sr@@i@@i

5) "NOS" conforms to NOS requirements for its tidal stations.

6) "NFDRS" conforms to NFDRS requirements for its fire weather stations.

Provides most recent data in a CR LF delimited ASCII readable format.

EXAMPLE:

00.00  
000  
270  
328  
110  
100  
14.0  
000  
000  
020  
0486

7) "INSAT" conforms to INSAT requirements for its stations.

Examples available on request (these specs are being changed)

8) "HANDAR" is a format where sensors are separated by <CRLF>, sensor data is separated with a space and missing data is an "M". The oldest data is first (to left).

EXAMPLE:

010034380517419:21:30G42+0NN155E9200070"  
1.3 1.3 1.3 1.3  
2.4 2.4 2.4 2.4  
M 12.2 12.2 12.2 12.2 12.3 12.3 12.3

## RANDOM TRANSMISSION PSEUDOBINARY DATA FORMAT

The format of the transmission data is:

<GROUP-ID> <OFFSET>  
<MEASUREMENT1-DATA(1)> <MEASUREMENT1-DATA(2)> ...  
<MEASUREMENT1-DATA(N)>



<MEASUREMENT2-DATA(1)> <MEASUREMENT2-DATA(2)> ...  
<MEASUREMENT2-DATA(N)>  
<MEASUREMENT3-DATA(1)> <MEASUREMENT3-DATA(2)> ...  
<MEASUREMENT3-DATA(N)>  
<COUNTER>  
<BATTLOAD>  
<LAT/LONG>

where:

|                  |   |
|------------------|---|
| GROUP ID         | The GROUP ID is a “2” for all random transmissions.   |
| OFFSET           | OFFSET is a 1-byte binary encoded number indicating the number of minutes ago the most recent data was recorded. Note that the number of minutes is calculated about 15 seconds prior to transmission.  |
| MEASUREMENT DATA | <p>Measurement data collected by Satlink Logger: this data contains only those measurements set up to be included in the random transmission. The data values are 3 byte binary encoded signed numbers allowing a range of: -131072 to +131071. The actual 6-bit binary encoded format is described later. The value transmitted is taken directly from the 32 value measurement buffer in Satlink Logger. The value transmitted will be value * 10<sup>RightDigits</sup>. The string "///" will be sent if the data was never measured or was erased.</p> <p>The number of values sent for each measurement is set separately for each measurement in the Random Transmissions, Num values to Tx field. Note that this is different from the 8210 where the num values to Tx was the same for each sensor. As a result, Satlink Logger sends all the required values for one sensor (most recent first) before proceeding to the next measurement. In the 8210, values were interleaved.</p> |

## LAT/LONG

This is an optional field; it will be included only if “Append Lat/Long” is selected for random transmissions.

LAT/LONG can be decoded into D:M:S format by converting the binary values to decimal and applying the following formula:

Degrees latitude =  $64 * (1^{\text{st}}\text{-byte AND } 63) + (2^{\text{nd}}\text{-Byte AND } 63) - 180$

Minutes latitude =  $3^{\text{rd}}\text{-byte AND } 63$

Seconds latitude =  $4^{\text{th}}\text{-byte AND } 63$

Degrees longitude =  $64 * (5^{\text{th}}\text{-byte AND } 63) + (6^{\text{th}}\text{-Byte AND } 63) - 180$

Minutes longitude =  $7^{\text{th}}\text{-byte AND } 63$

Seconds longitude =  $8^{\text{th}}\text{-byte AND } 63$

For example BAAODAXe would be decoded as Lat N 39o 1' 15.79" Long W 77o 24' 37.19"

## COUNTER

COUNTER is a 2 byte binary encoded number which indicates the transmission number and increments after every transmission. The number will be between 0 and 4095.

## BATTLOAD

BATTLOAD is a 1 byte binary encoded number representing the battery voltage of Satlink Logger under load during the last transmission. If the battery reading is zero, then that is the first transmission since bootup. The range of the number will be -32 to +31 and can be converted to volts by multiplying by 0.234 and adding 10.6 allowing a range of 3.1 to 18.1 volts.

## EXAMPLE:

Here is a message with three active measurements; each one is set to include two readings. The random buffer contains the string "EXT". This string was given by an external device through the RS-232 port.

```
2@@Gt@Gs@Sx@Sr@@i@@iBAAODAXe@GI
| | | | | | | | | |
| | | | | | | | | +- Battery Voltage
| | | | | | | | | +--- Random Counter
| | | | | | | | | +----- Lat/Long (optional)
| | | | | | | | | +----- Temp #2
| | | | | | | | | +----- Temp #1
| | | | | | | | | +----- Precip #2
| | | | | | | | | +----- Precip #1
| | | | | | | | | +----- Stage #2
| | | | | | | | | +----- Stage #1
| | | | | | | | | +----- Delta Time
```

+----- Group ID = 2

## SCHEDULED PSEUDOBINARY DATA FORMAT

The format of the transmission data is identical to the Random Pseudobinary format except that the message starts with a BLOCK-IDENTIFIER B, the GROUP-ID is a 1, and there is no count. The transmission includes data from any measurement that has the "Scheduled Transmissions: Include" box checked. The number of values to send in each message is set by the num values to Tx field.

<GROUP-ID> <OFFSET>  
<MEASUREMENT1-DATA(1)> <MEASUREMENT1-DATA(2)> ...  
<MEASUREMENT1-DATA(N)>  
<MEASUREMENT2-DATA(1)> <MEASUREMENT2-DATA(2)> ...  
<MEASUREMENT2-DATA(N)>  
<MEASUREMENT3-DATA(1)> <MEASUREMENT3-DATA(2)> ...  
<MEASUREMENT3-DATA(N)>  
<BATTLOAD>  
<LAT/LONG>

|                  |   |
|------------------|---|
| BLOCK IDENTIFIER | BLOCK-IDENTIFIER is always sent as "B" to indicate the start of a binary data group.  |
| GROUP ID         | GROUP-ID is always sent as "1" to indicate the scheduled group.   |
| OFFSET           | Each record is prefixed with an <OFFSET>, which is a 1 byte binary encoded number indicating the number of minutes ago the most recent data was recorded. Note that the number of minutes is calculated about 15 seconds prior to transmission.   |
| MEASUREMENT DATA | <p>Measurement data collected by Satlink Logger: This data contains only those measurements set up to be included in the scheduled transmission. The data values are 3 byte binary encoded signed numbers allowing a range of: -131072 to +131071. The actual 6-bit binary encoded format is described later. The value transmitted is taken directly from the 32 value measurement buffer in Satlink Logger. The value transmitted will be value * 10<sup>RightDigits</sup>. The string "///" will be sent if the data was never measured or was erased.</p> <p>The number of values sent for each measurement is set separately for each measurement in the Scheduled Transmissions, Num values to Tx field. Note that this is different from the 8210 where the num values to Tx was the same for each sensor. As a result, Satlink Logger sends all the required values for one sensor (most recent first) before proceeding to the next measurement. In the 8210, values were interleaved.</p> |
| BATTLOAD         | BATTLOAD is appended if the "Append Quality" box is checked.. This is a 1 byte binary encoded number representing the battery voltage of <b>Satlink Logger under load</b> during the last transmission. If the battery reading is zero, then that is the first transmission since bootup. The range of the number will be -32 to +31 and can be converted to volts by multiplying by 0.234 and adding 10.6 allowing a range of 3.1 to 18.1 volts.   |

## LAT/LONG

This is an optional field; it will be included only if “Append Lat/Long” is selected for random transmissions.

LAT/LONG can be decoded into D:M:S format by converting the binary values to decimal and applying the following formula:

Degrees latitude =  $64 * (1\text{st-byte AND } 63) + (2\text{nd-Byte AND } 63) - 180$

Minutes latitude =  $3^{\text{rd}}\text{-byte AND } 63$

Seconds latitude =  $4^{\text{th}}\text{-byte AND } 63$

Degrees longitude =  $64 * (5\text{th -byte AND } 63) + (6\text{th -Byte AND } 63) - 180$

Minutes longitude =  $7^{\text{th}}\text{-byte AND } 63$

Seconds longitude =  $8^{\text{th}}\text{-byte AND } 63$

For example BAAODAXe would be decoded as Lat N 39o 1' 15.79" Long W 77o 24' 37.19"

## EXAMPLE:

Here is a message with three active measurements; each one is set to include two readings. The scheduled buffer contains the string "EXT". This string was given by an external device through the RS-232 port.

```
B1@@Gt@Gs@Sx@Sr@@i@@iEXTIBAAODAXe1
|||| | | | | | | ||
|||| | | | | | | | +----- Lat/Long (optional)
|||| | | | | | | +----- Battery (optional)
|||| | | | | | +----- External
|||| | | | | +----- Temp #2
|||| | | | +----- Temp #1
|||| | | +----- Precip #2
|||| | +----- Precip #1
|||| +----- Stage #2
||| +----- Stage #1
|| +----- Delta Time
| +----- Group ID
+----- Block ID
```

## SCHEDULED SHEF DATA FORMAT

The format of the transmission data is:

```
":" <LABEL1> <OFFSET> "#" <INTERVAL> <DATA1> <DATA1> ... <DATA1>>  
":" <LABEL2> <OFFSET> "#" <INTERVAL> <DATA2> <DATA2> ... <DATA2> ...  
":" <LABEL(N)> <OFFSET> "#" <INTERVAL> <DATA(N)> <DATA(N)> ... <DATA(N)>  
":BATTLOAD 0 " <BATTLOAD>  
<LAT/LONG>
```

|                    |  |
|--------------------|--|
| LABEL              | This is the Label entered in Satlink Logger in the Measurements:Settings:Label field. The Label can be a SHEF two character parameter code such as HF for gauge height or PC for cumulative precipitation or it can be any string you enter. Refer to <a href="http://noaasis.noaa.gov/DCS/htmlfiles/schefcodes.html">http://noaasis.noaa.gov/DCS/htmlfiles/schefcodes.html</a> for a list of SHEF codes commonly used.  |
| OFFSET             | Each record is prefixed with an <OFFSET>, which is an ASCII number indicating the number of minutes ago the most recent data was recorded. Note that the number of minutes is calculated about 15 seconds prior to transmission.   |
| INTERVAL           | INTERVAL indicates how often the measurement was made.   |
| MESUREMENT<br>DATA | This is data collected by Satlink Logger through measurements. Only those measurements with the Scheduled Transmissions Include box checked are included in the transmission.<br>Like the binary formats, the SHEF format groups all the related data from one measurement. The data is transmitted in ASCII with sign and decimal point (if needed). If a data value has not yet been recorded (or has been erased) the letter "M" for missing data will be sent. The most recent data is always sent first. The number of values sent for each measurement is set on a measurement by measurement basis. |



## SIX-BIT BINARY ENCODED FORMAT

The six bit binary format is used to encode numbers into displayable ASCII characters. Notice that fractional numbers cannot be represented, so for instance a battery voltage of 13.04 volts set up with 2 right digits will be sent as 1304.

A 1 byte encoded number can range from -32 to +31.

A 2 byte encoded number can range from -2048 to +2047

A 3 byte encoded number can range from -131072 to +131071

Binary encoded numbers are always sent most significant bytes first. The number itself is broken down into 6-bit digits, and each digit is placed in one byte of data. The number 64 (ASCII "@") is added to each digit to make it fall within the range of displayable ASCII characters. The only exception is that 127 (ASCII <DEL>) is sent as 63 (ASCII "?")

Example 1. Encoding the number 10 in 1 byte:

Since 10 will fit in 6-bits we only have to add 64 which would yield 74. So the number 10 would appear as ASCII 74 or the letter "J".

Example 2. Encoding the number 12345 in 3 bytes:

First we have to convert 12345 into binary in 6-bit pieces:

12345 (base 10) = 11 000000 111001 (base 2)

Now we can convert each piece back to base 10:

11 000000 111001 (base 2) = 3, 0, 57

Finally, we add 64 to each piece and convert to ASCII:

67, 64, 121 = ASCII "C@y"

Example 3. Encoding the number -12345 in 3 bytes:

First we have to convert -12345 into two's complement 18-bit binary: -12345 (base 10) = 111100 111111 000111 (base 2)

Now we can convert each piece back to base 10: 111100 111111 000111 (base 2) = 60, 63, 7

Finally, we add 64 to each piece and convert to ASCII (since the second piece is 63 we leave it alone):

124, 63, 71 = ASCII "|?G"

Example 4. Decoding the 3 byte string "@SW":

This is just like encoding except we follow the steps backward.

First we convert all the characters to ASCII decimal codes:

ASCII "@SW" = 64, 83, 87

Now we subtract 64 from each piece and convert to 6-bit binary:

0, 19, 23 = 000000 010011 010111

Finally, we combine all the bits to form one 18-bit two's complement number and convert to base 10:

000000010011010111 = 1239



## ASCII COLUMN FORMAT

The ASCII Column format is another means of encoding transmission data. A message formatted with this method would look like this:

```
<CRLF>
Meas1_Data(1) Meas2_Data(1) ... MeasN_Data(1)<CRLF>
Meas1_Data(2) Meas2_Data(2) ... MeasN_Data(2)<CRLF>
Meas1_Data(n) Meas2_Data(n) ... MeasN_Data(n)<CRLF>
```

- <CRLF> is a carriage return, line feed
- Meas1\_Data()..MeasN\_Data are the data from the active measurements included in the transmission.
- All the data on one line are for the same time. A space separates the values. The newest data is sent first.
- (n) is the number of values included in the transmission as set by the user.
- The format for any value is ASCII with the right digits set by the user.
- No decimal point is shown if the value is zero.
- Add a minus sign in front of the value if the value is negative.
- There are no leading zeroes.
- If the value is missing, two forward slashes are transmitted instead //.

A typical message will appear as follows:

```
41.79 60.99 12.99 12.43 .20 8.08 7.1 195.2
41.79 60.99 12.99 12.43 1.20 8.08 7.1 195.2
41.79 60.99 12.99 12.43 -2.20 8.08 7.1 195.2
```

Normally the DCP will be set up so all the sensors are collected at uniform times. If this is not the case, the formatter will still work but will have varying amounts of data on each line (each time) based on whatever sensors are collected at each time. This will produce confusing results if the additional sensors are collected at an interval of the other sensors. The results should be OK if the additional sensors are collected at a time separate time.

## ASCII SENSOR FORMATTING

This method of formatting uses four digits for each measurement readings. Measurement readings are multiplied by 100 before being transmitted.

```
<CRLF>  
IDIDIDID JJJHHMMSS<CRLF>  
Meas1_Data(1) Meas1_Data(2) ... Meas1_Data(n)<CRLF>  
Meas2_Data(1) Meas2_Data(2) ... Meas2_Data(n)<CRLF>  
MeasN_Data(1) MeasN_Data(2) ... MeasN_Data(n)<CRLF>  
optional Battery before transmission<CRLF>  
optional Battery under load<CRLF>
```

- <CRLF> is a carriage return, line feed
- IDIDIDID is the eight byte hexadecimal satellite ID
- JJJ is a three digit Julian Day, which is the number of days of the year. January 1st is Julian Day one, and February 1st is Julian Day 32. This number is always three digits (0 padded)
- HHMMSS are the hours minutes and seconds. This is the time of the scheduled transmission. It is always 6 bytes (0 padded).
- Meas1\_Data()..MeasN\_Data are the data from the active measurements included in the transmission.
- Measurement data is always four digits followed by a space (0 padded).
- All values are multiplied by a 100.
- No decimal point is used for measurement data.
- Range of transmitted data is 0 to 9999 (numbers out of range are transmitted as 0000 or 9999). This means that the sensor data should be between 0 and 99.99 before formatting.
- If the user elects to append battery voltage (see page 61), one of the two will be appended:
  - If the transmission satellite is Japan MTSAT (GMS) or Meteosat MSG, only one line of battery voltage information will be added. It will take this format: “13.5<CR><LF>” Three digits and a decimal point are always used. It is the battery voltage prior to the transmission.
  - For all other transmission types, two lines of battery voltage information will be added. Both lines take the same format: “12.5<CR><LF>” (three digits of battery voltage and a decimal point). The first line is the battery voltage prior to this transmission. The second line is the battery voltage during the last transmission.

This is an example transmission:

```
010570F2 108183053  
0250 0250 0250 0250  
2231 2232 2233 2234
```

12.2  
12.1

1. On the first line 010570F2 represents the hexadecimal satellite ID. 108 is the Julian Day (for the year 2005, that is April 18<sup>th</sup>). 183053 means 18 hours 30 minutes and 53 seconds.
2. The second line (0250 0250 0250 0250) shows four readings of the first sensor. This measurement had four same readings. Before formatting, that reading was 2.50. It was multiplied by 100 and padded with a leading zero.
3. The third line (2231 2232 2233 2234) shows four different readings of the second sensor. That sensor's readings were originally 22.31, 22.32, 22.33, and 22.34 respectively. They were multiplied by 100 and padded with a leading zero.
4. The fourth line (12.2) is the battery reading in Volts prior to transmission.
5. The last line (12.1) is the battery reading in Volts during the last transmission.

## DATA RECEIVED THROUGH DAPS

Once data transmitted by Satlink is retrieved, it will have information added on by the NESDIS satellite receiver system. This information was gathered from the "User Interface Manual (UIM)

Version 1.1 for the GOES Data Collection System Automatic Processing System (DAPS)". Here is an example of a message sent by Satlink and received by the DAPS system:

```
010570F207141162408G40-2NN195EFF00062 SATLINK DATA BUFFER EMPTY  
Alive TIME 2007/05/21 12:23:54
```

SATLINK DATA BUFFER EMPTY Alive TIME 2007/05/21 12:23:54 is data sent by Satlink. All the preceding bytes constitute the header added by DAPS. Here is an explanation of the header.

- The first six bytes 010570F2 are the hexadecimal satellite ID. This is the same as the ID that Satlink is setup with. It is sometimes referred to as the address.
- 07 is the year. 07 means 2007.
- 141 is a three digit julian day of the year. January 1st is Julian Day one, and February 1st is Julian Day 32. This number is always three digits (0 padded)
- 162408 is the time of day. 16:24:08. 16 is 4 PM military time, 24 is the number of minutes and 08 the number of seconds.
- G is the Failure Code 1. It can be
  - G - Good message
  - ? - Message received with parity errors
  - W - Message received on wrong channel
  - D - Message received on multiple channels (duplicate)
  - A - Message received with address error(s) (correctable)
  - T - Message received late/early (time error)
  - U - Unexpected message
  - M - Missing message
  - N - PDT entry for this platform is not complete

- 40 is EIRP or received signal strength (implied EIRP, assuming that the pilot is a +47 dBm reference). Signal strength is output as two ASCII digits ranging between 32 and 57 (decimal). The nominal operating range is 44 to 49 dBm.
- -2 is the Frequency Offset. The first byte is an ASCII plus (+) or minus (-) sign, the second byte is an ASCII number zero (0) through nine (9) or the ASCII character "A". The number indicates the amount in increments of 50 Hz. The character "A" represents 500 Hz which is the worst case frequency error that the DAMS units can acquire. The nominal operating range for frequency offset is +250 Hz (+5).
- N is the Modulation Index. It can be
  - N for normal (desired)
  - L for low
  - H for high
- N is the Data Quality. It can be
  - N (Normal, error rate better than  $1 \times 10^{-6}$ )
  - F (Fair, error rate between  $1 \times 10^{-4}$  and  $1 \times 10^{-6}$ )
  - P (Poor, error rate worse than  $1 \times 10^{-4}$ )
- 195 is the transmission channel
- E is the spacecraft. It can be E for east or W for west.
- FF is the uplink carrier status
- 00062 means that 62 bytes of non-header data were received
- There is a space after 62 and before SATLINK. It is the quality flag:

|           |      |                                  |
|-----------|------|----------------------------------|
| " (quote) | 0x22 | Clock updated since last TX      |
| (space)   | 0x20 | Clock not updated since last TX  |
| b         | 0x62 | Clock updated, Pseudo Binary     |
| `         | 0x60 | Clock not updated, Pseudo Binary |
| B         | 0x42 | Clock updated, BINARY            |
| @         | 0x40 | Clock not updated, BINARY        |

# APPENDIX I: DIMENSIONS

# XLITE DATA LOGGER

Dimensions are shown in inches:

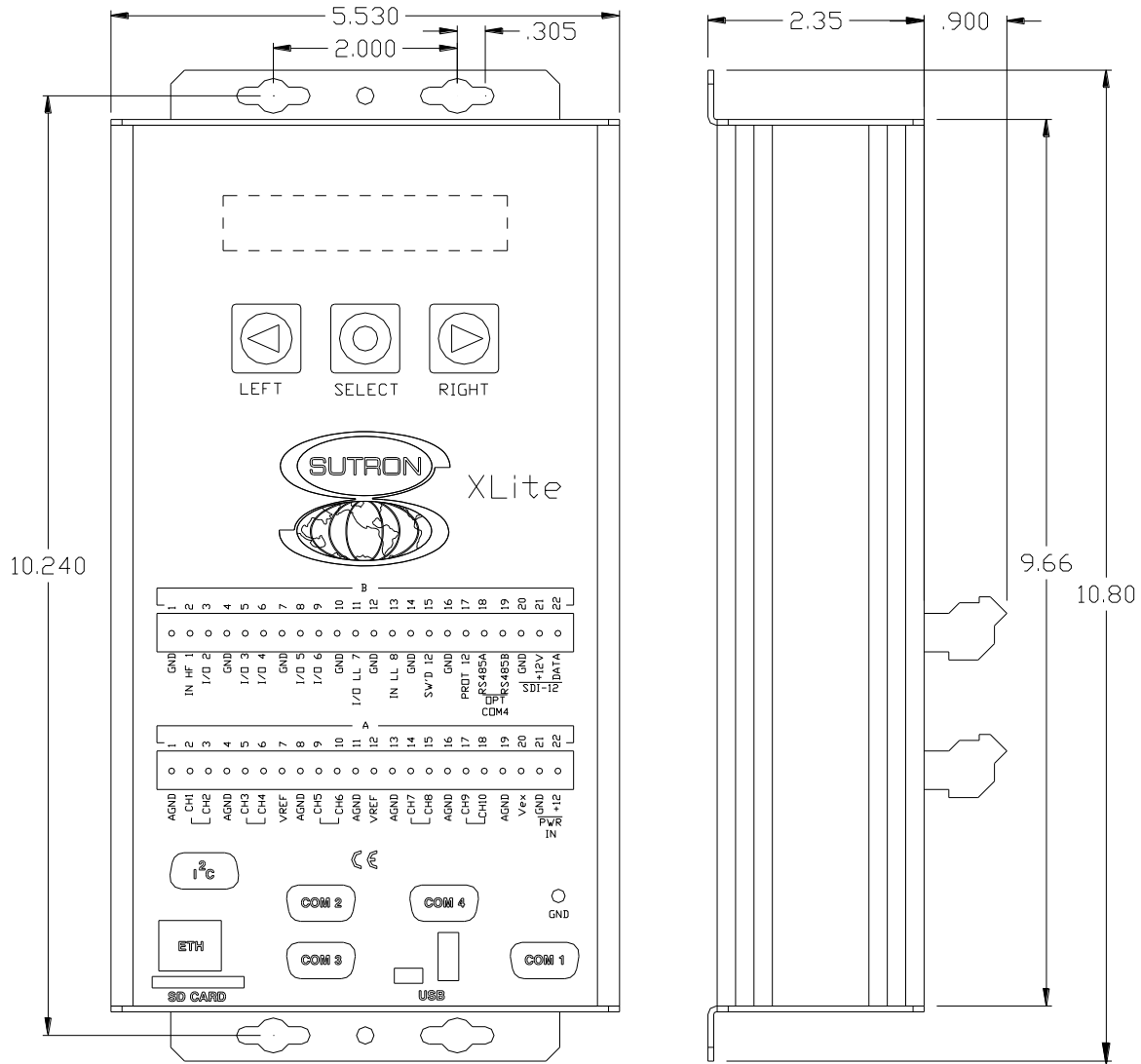

# EXTERNAL I/O MODULES

Dimensions shown are in inches. Note that on the 8080-0007 module, the two 6-32 screws located 3.00 inches apart on the rear of the module provide the earth grounding for the transient protection.

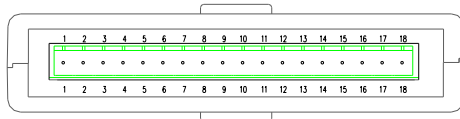
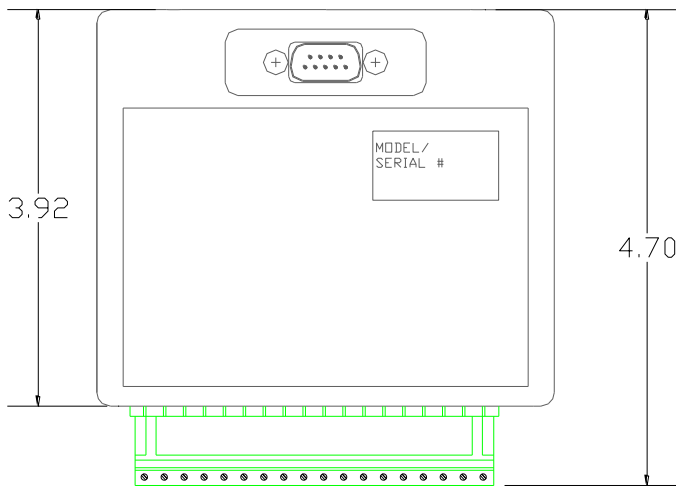
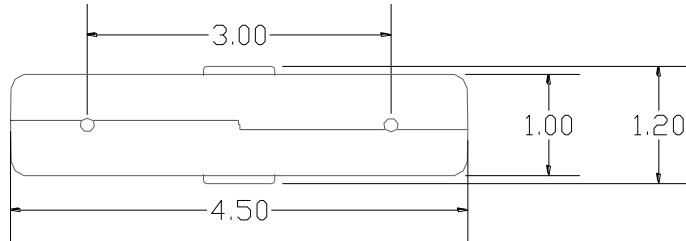

VIEW B - B  
-1 & -2 ASSY

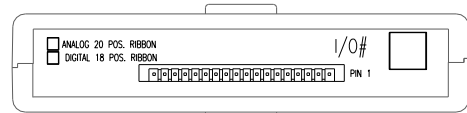

VIEW B - B  
-3 & -4 ASSY

# EXTERNAL MODEM

Dimensions are shown in inches:

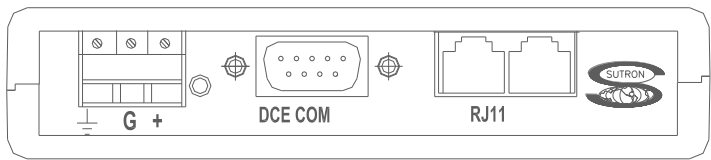
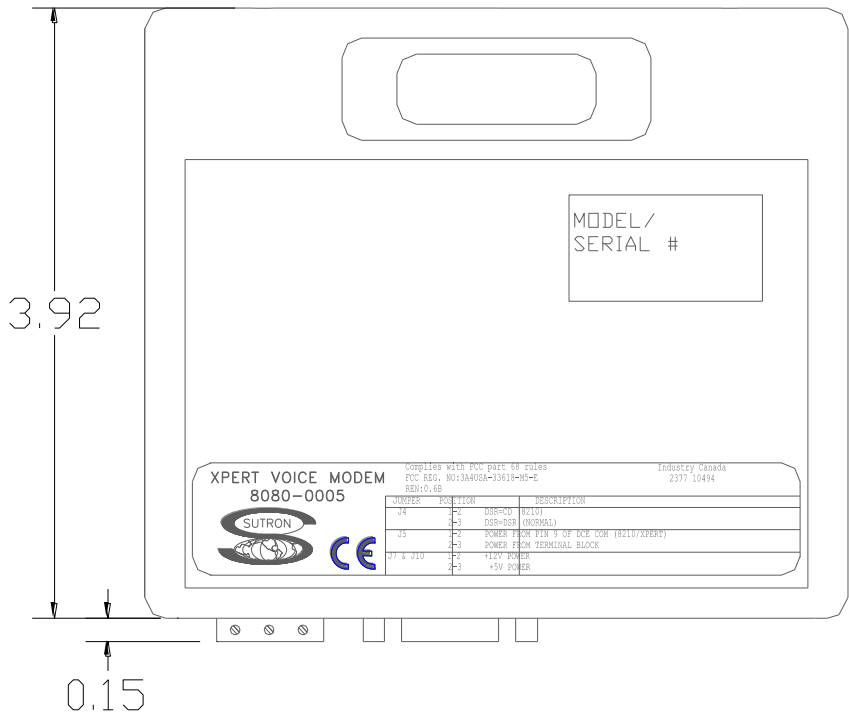
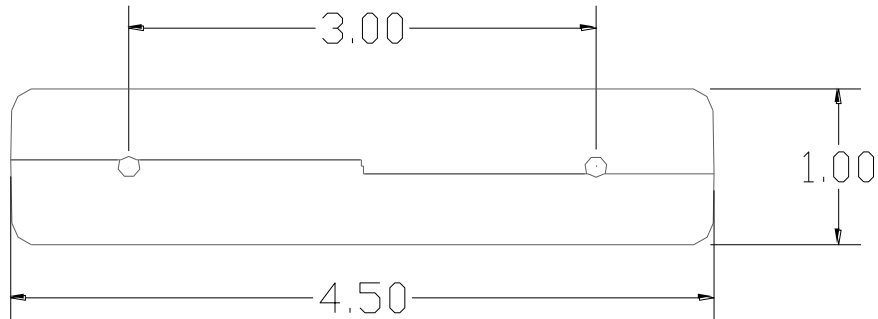



## Index

**5**

- 5600-0600, 190
- 5600-0601, 190
- 5600-0602, 190
- 5600-0603, 190
- 5600-0605, 190
- 56-109 Submersible Pressure Transducer, 192

**8**

- 8080-0002-1, 5, 275
- 8080-0003 Analog I/O Module
  - configuration examples, 271
- 8080-0003-1, 5, 267
- 8080-0005-1, 5, 279
- 8080-0006-1, 160
- 8080-0007 Analog I/O Module
  - configuration examples, 274
- 8080-0007-1, 5, 272

**9**

- 9210
  - models, 5
- 9210-0000-1, 5, 279

**A**

- access levels, 20
- accounts
  - managing, 59
  - overview, 20
- accuracy
  - Analog I/O module, 270
- ADC block, 136–42
- Air Temperature sensor block, 134
- Air Temperature/Relative Humidity sensor block, 136
- Alarm block, 25, 198
- alarms
  - block, 198
  - configuring, 25–42, 53, 161, 198, 237, 239, 249
  - Digital I/O Module features, 275
  - XLite Digital Module features, 265

- alerts, 25–42
- Analog block, 136–42
- Analog I/O Module
  - accuracy, 270
  - inputs, 269
  - measurements, 269
  - operational states, 269
  - outputs, 269
  - plug assignments, 267, 272
- Append Lat/Long, 304, 307, 309
- Append Quality, 306, 309
- appending
  - random transmissions, 53
  - self-timed transmissions, 51
- Aquatrak block, 184
- ASCII Column Formatting, 311
- ASCII Sensor Formatting, 312
- AT/RH block, 136
- Auto Update, 118
- autoexec.bat, 130, 286
- Average Block, 201

**B**

- bad data quality, 68
- Barometric Pressure sensor block, 143
- battery
  - Internal Battery block, 167, 168
  - replacing, 131
- Battery
  - Voltage Under Load, 304, 306, 309
- BEIEnc block, 144
- Bin\_Int format, 51, 53, 301
- Bin\_NonInt format, 51, 53, 301
- binary formatting, 310
- Binary Input – All Channels block, 147
- Binary Input block, 145
- binary input mode, 147
- Binary Out block, 247
- BinIn block, 145
- BinInAllChan block, 147
- BinOut block, 247
- blocks
  - adding, 89–92
  - categories, 85
  - connecting, 86

- control blocks. *See* control blocks
- deleting, 97
- inputs and outputs, 85
- log blocks. *See* log blocks, *See* log blocks, *See* log blocks
- miscellaneous blocks. *See* miscellaneous blocks
- overview, 3
- processing blocks. *See* processing blocks
- properties, 87, 92
- sensor blocks. *See* sensor blocks
- telemetry blocks. *See* telemetry blocks
- wiring, 95

**BLOCKS**

- modify, 95

Bool block, 203

BP block, 143

Bridge Resistance block, 149

Burst, 53, 54

Burst Int, 53

## C

- calibrate
  - sensors
    - XPert, 61
  - sensors, 74
- CapRain block, 150
- Center in Window, 50
- Change Setup, 75, 76, 77
- channel
  - binary input, 145
  - random, 53
  - self-timed, 51
- cleaning, 131
- clearing log, 68
- Com ports
  - configuring, 25–30
  - pin assignments, 126–27
  - testing, 30
- Communication Test Menu, 30
- Coms Tag block, 237
- COMx, 286
- connection settings in XTerm, 117
- Constant block, 152
- ConstIn block, 152
- contrast

- adjusting from Login screen, 9
- adjusting on XLite, 9, 130
- control blocks. *See Also* blocks
  - Binary Out, 247
  - Pulse Out, 248
- count, 201, 207
- Counter block, 154
- Counts per Turn drop down box, 180
- CS107 Temperature sensor block, 156
- CS505 Fuel Moisture sensor block, 160
- current measurement, 137, 141

## D

- data column (log file), 67
- data modem. *See* modems:data modem
- date
  - column (log file), 68
  - displaying with XLite, 73
  - setting, 21
- Day buttons, 68
- Deleting a Block, 97
- Deleting Multiple Blocks, 97
- Dew point block, 204, 206
- Dial-In Commands, 32
- Dial-Out Commands, 32
- Digital I/O Module, 275
  - counters, 276
  - digital filters, 276
  - features, 275
  - frequency, 276
  - inputs, 276
  - outputs, 277
  - plug assignments, 275
  - shaft encoders, 277
  - specifications, 275
- direct connect, 25–31
- Display block, 250
- Display Status, 73
- Display Values, 74
- DLLs, 3
  - overview, 3
- DoubleVolts, 140
- DQAP block, 207
- Dump Log Data, 76, 78

## E

enable  
  excitation channel, 142  
  random transmissions, 52, 241  
  self-timed transmissions, 50  
  temperature, 143  
excitation channel, 142  
exit, 72, 73  
exporting log files, 67, 69  
EzSetup Measurements, 37  
  overview, 3

## F

Field Variable blocks, 64, 251  
File Transfer, 115  
Find button, 62, 68  
FM block, 160  
formats, transmission, 51, 53  
Formatting  
  ASCII Column, 311  
  ASCII Sensor, 312  
  pseudobinary, 302  
  scheduled pseudobinary, 306  
  SHEF, 308  
  six-bit binary, 310  
Freq block, 158  
Frequency block, 158  
Fuel Moisture sensor block, 160  
fuses, 131

## G

GetTag block, 161  
Gill Wind block, 162  
good data quality, 68  
Graphical Setup, 42  
Graycode input mode, 147  
GUI  
  operation, 19–75

## H

Hi Alarm, 199

## I

I/O Modules, 3, 9, *See* Analog I/O Modules,  
  Digital I/O Modules, XLite:Analog  
  Module, XLite:Digital Module  
Initialize Satlink, 50  
Insert a Block, 98  
installation  
  autoexec.bat, 286  
  COM ports, 126–27  
  remote.exe, 286  
  XTerm, 109  
Internal Battery block, 167, 168  
Interpolate block, 209, 211

## K

kernel  
  updating, 259

## L

Label  
  SHEF formatting, 308  
Lat/Lon, 51, 53  
latitude, 304, 307  
linear sensors, 135  
live measurements, 61  
log blocks, 229, 231, 233, *See Also* blocks,  
  *See Also* blocks, *See Also* blocks  
log files  
  blocks. *See* log blocks, blocks, *See* log  
    blocks, blocks, *See* log blocks, blocks  
  clearing, 68  
  creating, 46  
  data column, 67  
  date column, 68  
  Day buttons, 68  
  exporting, 67, 69  
  Find button, 68  
  managing, 46  
  navigating, 68  
  properties, 46  
  Q (quality) column, 68  
  selecting, 68  
  sensor column, 67  
  time column, 67  
  units column, 68

- viewing, 67
- login, 20
- logout, 20, 22, 23
- longitude, 304, 307
- LOS Radio modem. *See* modems:LOS radio modem
- Low Alarm, 199

## M

- Main tab, 21–23
- maintenance, 23, 130
- max, 201
- Measure block, 212
- Measurement
  - interval, 308
  - Label setting, 308
- measurements
  - analog, 136–42, 269
  - live, 61
- min, 201
- Minimum/Maximum block, 213
- miscellaneous blocks. *See Also* blocks
  - Display, 250
  - Set Field Variables, 251
- missing data, 308
- models, 5
- modems
  - data modem, 36
  - LOS Radio modem, 36, 280
  - speech modem, 5, 279
- MODEMx, 287
- Moving Average block, 214
- multiplier, 158

## N

- NESDIS, 51, 301
- NFDRS format, 51, 302
- Norm Rate, 53
- NOS format, 51, 302

## O

- operation, 19–75

## P

- passwords, 20, 60

- period, 158
- Platinum RTD block, 175, 178
- Polynomial block, 215
- powering up, 9
- Precip block, 193
- precision, 94
- prefix, 237
- Process List Folder, 116
- processing blocks. *See Also* blocks
  - Accum, 200
  - Alarm, 198
  - Average, 201
  - Boolean, 203
  - DQAP, 207
  - Interpolate, 209, 211
  - Measure, 212
  - Minimum/Maximum, 213
  - Moving Average, 214
  - Point Control, 216
  - Polynomial, 215
  - Set Point Control, 218
  - Solar Radiation Accumulation block, 219
  - Vector Average, 221
  - XY Function, 223, 228
- Processing blocks
  - Dew Point, 204, 206
- product description, 4
- pseudobinary format
  - random transmission, 302
  - scheduled transmission, 306
- PtCtrl, 216
- Pulse Out block, 248
- PulseOut block, 248

## Q

- Quadrature Shaft Encoder block, 180
- quality, 306, 309
  - appending to random transmission, 53
  - appending to self-timed transmission, 51
  - column (log file), 68

## R

- radio modem. *See* modems:LOS Radio modem
- RADIOx, 287
- Random Group block, 239

Random Parameter block, 241  
Random Properties, 52  
Random Test, 55  
Rate, 52, 53  
recording status  
    Xlite, 22  
    XLite, 73  
Refresh button, 56, 71  
remote.exe, 286  
Reset button, 44, 56  
Reset FS button, 56  
resistance measurements, 138, 139, 142  
Right Digits, 310  
RM Young Wind Sensor block, 181  
RndGroup block, 239  
ROC Alarm, 199  
RS232 modules specifications, 279

## S

sample  
    duration, 201, 208  
    interval, 201, 208  
satellite ID, 49  
Satlink  
    description, 280  
    installation, 126–27  
    properties, 49  
    random properties, 52  
    random test, 55  
    self-timed properties, 50  
    **self-timed test**, 54  
    Status, 56  
schedule  
    interval, 201, 208  
    time, 201, 208  
SDI AquaTrak block, 184  
SDI-12. *See Also* Digital I/O Modules,  
    XLite Digital Module  
    commands, 62  
SDI-12 block, 183  
SDIAqua block, 184  
SDK, 282, 284  
SE8500 block, 185  
Self Test, 56  
Self-Timed Parameter block, 242  
Self-Timed properties, 50

**Self-Timed Test**, 54  
SendTag block, 249  
sensor blocks. *See Also* blocks  
    Air Temperature, 134  
    Air Temperature/Relative Humidity, 136  
    Analog, 136–42  
    Barometric Pressure, 143  
    BEI Absolute Encoder, 144  
    Binary Input, 145  
    Binary Input - All Channels, 147  
    Bridge Resistance, 149  
    CapRain, 150  
    Constant, 152  
    Counter, 154  
    CS107 Temperature Sensor, 156  
    Frequency, 158  
    Fuel Moisture, 160  
    GetTag, 161  
    Gill Wind, 162  
    Internal Battery, 167, 168  
    Platinum RTD, 169, 170, 172, 175, 178  
    Quadrature Shaft Encoder, 180  
    R.M. Young Wind, 181  
    SDI AquaTrak, 184  
    SDI-12, 183  
    SE8500, 185  
    Soil Moisture, 164, 186, 187, 189  
    Solar Radiation, 190  
    Submersible Pressure Transducer, 192  
    Tipping Bucket, 193  
    Volt Meter, 196, 197  
sensor column (log file), 67  
sensors  
    calibrating, 61  
    live measurements, 61  
    properties, 61  
    sending SDI-12 commands, 62  
    viewing, 61, 63  
Set Clock. *See Also* date:setting, time:setting  
    XTerm control, 117  
Set Field Variables block, 251  
Set Point Control block, 218  
SetFieldVar block, 251  
SetPoint block, 218  
setup. *See Also* blocks  
    blocks. *See* blocks

- example, 85
- new, 89
- setup blocks. *See* blocks
- Setup File, 58
- Shaft Encoder block, 180
- SHEF, 308
- SHEF format, 51, 301
- six-bit binary formatting, 310
- SLLs, 282
- Software Development Kit, 282, 284
- Soil Moisture block, 164, 186, 187, 189
- Solar Radiation Accumulation block, 219
- Solar Radiation sensor block, 190
- specifications
  - Digital I/O Module, 275
  - RS232 modules, 279
  - XLite, 279
- speech
  - Coms Tag block, 237
  - files
    - creating, 284
    - loading, 124
    - introduction, 25
    - modem. *See* modems:speech modems
- SR block, 190
- SSP, 161, 237, 249
- standard deviation, 201, 207
- station name
  - XLite, 22
- Status button, 54, 55
- Status Options dialog, 71
- Status tab, 71
- STD, 201, 207
- Submersible Pressure Transducer block, 192
- SubPres block, 192
- suffix, 237
- Sutron Link Libraries, 282
- Sutron Speech/Voice modem. *See* modems:speech modem

## T

- telemetry blocks. *See Also* blocks
  - Coms Tag, 237
  - Random Group, 239
  - Random Parameter, 241
  - Self-Timed Parameter, 242

- SendTag, 249
- Telemetry modules, 5
- temperature sensor block. *See* Air
  - Temperature sensor block, Air
  - Temperature/Relative Humidity sensor block, CS107
  - Temperature sensor block
- Test check box, 152
- tests
  - communication, 30
  - I/O Modules, 9
  - initial, 9
  - random, 55
  - self-timed**, 54
- thermistor, 134, 156
- time, 52
  - column (log file), 67
  - displaying with XLite, 73
  - setting, 21, 117
- Tipping Bucket Sensor block, 193
- Transmission
  - append lat/long, 304, 307
- troubleshooting, 130
- Type, 52, 53

## U

- units column (log file), 68
- unpacking, 8
- update
  - application, 260
  - extension, 259
  - kernel, 259
  - remote.exe, 286
- Upgrade, 117
- users, 20, 59

## V

- VectAvg block, 221
- Vector Average block, 221
- View Data tab, 63
- View Log Data, 76
- View Log tab, 67–70
- voice modem. *See* modems:speech modem
- VOICEx, 287
- Volt Meter block, 196, 197
- voltage measurement, 137, 141
- VoltMeter block, 196, 197

## W

Web Server, 117  
window, transmission time, 52  
Wire button, 96  
wiring, 95  
wrap, 47

## X

### XLite

Analog Module - A terminal strip, 262  
Digital Module - B terminal strip  
connections, 264  
counters, 266  
digital filters, 266  
frequency, 266  
inputs, 265  
outputs, 266

shaft encoders, 266  
operating the display, 73  
picture, 4  
specifications, 279  
XTerm. *See Also* remote.exe  
auto update, 118  
connect, 117  
file transfer, 115  
installation, 109  
introduction, 109  
operating, 113  
preparing the 9210 to work with XTerm,  
113  
set clock, 117  
Upgrade, 117  
web server, 117  
XY Function block, 223, 228  
XYFunc block, 223, 228